

**GenX3™ 600V IGBT
with Diode**
IXGH36N60A3D4

$$V_{CES} = 600V$$

$$I_{C110} = 36A$$

$$V_{CE(sat)} \leq 1.4V$$

Ultra Low V_{sat} PT IGBT for
up to 5kHz switching

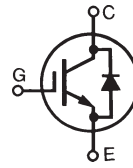

Symbol	Test Conditions	Maximum Ratings	
V_{CES}	$T_C = 25^\circ C$ to $150^\circ C$	600	V
V_{CGR}	$T_J = 25^\circ C$ to $150^\circ C$, $R_{GE} = 1M\Omega$	600	V
V_{GES}	Continuous	± 20	V
V_{GEM}	Transient	± 30	V
I_{C110}	$T_C = 110^\circ C$	36	A
I_{F110}	$T_C = 110^\circ C$	10	A
I_{CM}	$T_C = 25^\circ C$, 1ms	200	A
SSOA (RBSOA)	$V_{GE} = 15V$, $T_{VJ} = 125^\circ C$, $R_G = 5\Omega$ Clamped inductive load @ $\leq 600V$	$I_{CM} = 60$	A
P_C	$T_C = 25^\circ C$	220	W
T_J		-55 ... +150	$^\circ C$
T_{JM}		150	$^\circ C$
T_{stg}		-55 ... +150	$^\circ C$
T_L	1.6mm (0.062 in.) from case for 10s	300	$^\circ C$
T_{SOLD}	Plastic body for 10 seconds	260	$^\circ C$
M_d	Mounting torque	1.13/10	Nm/lb.in.
Weight		6.0	g

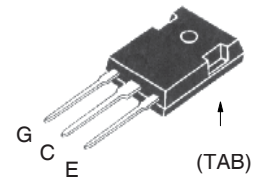
TO-247 (IXGH)

G = Gate C = Collector
E = Emitter TAB = Collector

Features

- Optimized for low conduction losses
- Square RBSOA
- Anti-parallel ultra fast diode
- International standard package

Advantages

- High power density
- Low gate drive requirement

Applications

- Power Inverters
- UPS
- Motor Drives
- SMPS
- PFC Circuits
- Battery Chargers
- Welding Machines
- Lamp Ballasts
- Inrush Current Protection Circuits

Symbol	Test Conditions ($T_J = 25^\circ C$ unless otherwise specified)	Characteristic Values		
		Min.	Typ.	Max.
$V_{GE(th)}$	$I_C = 250\mu A$, $V_{CE} = V_{GE}$	3.0		5.0 V
I_{CES}	$V_{CE} = 0.8 \cdot V_{CES}$ $V_{GE} = 0V$ $T_J = 125^\circ C$			75 μA 500 μA
I_{GES}	$V_{CE} = 0V$, $V_{GE} = \pm 20V$			± 100 nA
$V_{CE(sat)}$	$I_C = 30A$, $V_{GE} = 15V$, Note 1			1.4 V

Symbol	Test Conditions ($T_J = 25^\circ\text{C}$ unless otherwise specified)	Characteristic Values		
		Min.	Typ.	Max.
g_{fs}	$I_C = 30\text{A}, V_{CE} = 10\text{V}$, Note 1	25	42	S
C_{ies}	$V_{CE} = 25\text{V}, V_{GE} = 0\text{V}, f = 1\text{MHz}$		2380	pF
C_{oes}			115	pF
C_{res}			30	pF
Q_g	$I_C = 30\text{A}, V_{GE} = 15\text{V}, V_{CE} = 0.5 \cdot V_{CES}$		80	nC
Q_{ge}			12	nC
Q_{gc}			36	nC
$t_{d(on)}$	Inductive Load, $T_J = 25^\circ\text{C}$ $I_C = 30\text{A}, V_{GE} = 15\text{V}$ $V_{CE} = 400\text{V}, R_G = 5\Omega$		18	ns
t_{ri}			23	ns
E_{on}			0.74	mJ
$t_{d(off)}$			330	ns
t_{fi}			325	ns
E_{off}			3.00	mJ
$t_{d(on)}$	Inductive Load, $T_J = 25^\circ\text{C}$ $I_C = 30\text{A}, V_{GE} = 15\text{V}$ $V_{CE} = 400\text{V}, R_G = 5\Omega$		18	ns
t_{ri}			25	ns
E_{on}			1.50	mJ
$t_{d(off)}$			500	ns
t_{fi}			500	ns
E_{off}			5.30	mJ
R_{thJC}			0.56	$^\circ\text{C/W}$
R_{thCS}		0.21		$^\circ\text{C/W}$

TO-247 (IXGH) Outline

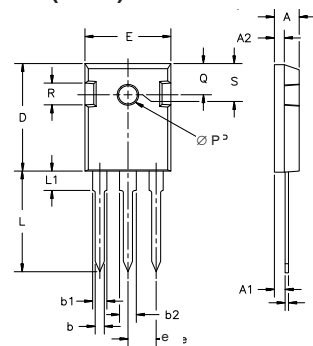

Dim.	Millimeter		Inches	
	Min.	Max.	Min.	Max.
A	4.7	5.3	.185	.209
A ₁	2.2	2.54	.087	.102
A ₂	2.2	2.6	.059	.098
b	1.0	1.4	.040	.055
b ₁	1.65	2.13	.065	.084
b ₂	2.87	3.12	.113	.123
C	.4	.8	.016	.031
D	20.80	21.46	.819	.845
E	15.75	16.26	.610	.640
e	5.20	5.72	0.205	0.225
L	19.81	20.32	.780	.800
L1		4.50		.177
∅P	3.55	3.65	.140	.144
Q	5.89	6.40	0.232	0.252
R	4.32	5.49	.170	.216
S	6.15	BSC	.242	BSC

Reverse Diode (FRED)

Symbol	Test Conditions ($T_J = 25^\circ\text{C}$, unless otherwise specified)	Characteristic Values		
		Min.	Typ.	Max.
V_F	$I_F = 10\text{A}, V_{GE} = 0\text{V}$, Note 1 $T_J = 150^\circ\text{C}$		1.7	3.0 V V
I_{RM}	$I_F = 10\text{A}, -di_F/dt = 200\text{A}/\mu\text{s}$ $V_R = 300\text{V}$	$T_J = 100^\circ\text{C}$	60	ns
t_{rr}		$T_J = 25^\circ\text{C}$ $T_J = 100^\circ\text{C}$		3 4
R_{thJC}				2.5 $^\circ\text{C/W}$

Note 1: Pulse test, $t \leq 300\mu\text{s}$; duty cycle, $d \leq 2\%$.

PRELIMINARY TECHNICAL INFORMATION

The product presented herein is under development. The Technical Specifications offered are derived from data gathered during objective characterizations of preliminary engineering lots; but also may yet contain some information supplied during a pre-production design evaluation. IXYS reserves the right to change limits, test conditions, and dimensions without notice.

IXYS reserves the right to change limits, test conditions and dimensions.

IXYS MOSFETs and IGBTs are covered by one or more of the following U.S. patents:

4,835,592	4,931,844	5,049,961	5,237,481	6,162,665	6,404,065 B1	6,683,344	6,727,585	7,005,734 B2	7,157,338B2
4,850,072	5,017,508	5,063,307	5,381,025	6,259,123 B1	6,534,343	6,710,405 B2	6,759,692	7,063,975 B2	
4,881,106	5,034,796	5,187,117	5,486,715	6,306,728 B1	6,583,505	6,710,463	6,771,478 B2	7,071,537	

**Fig. 1. Output Characteristics
@ 25°C**

**Fig. 2. Extended Output Characteristics
@ 25°C**

**Fig. 3. Output Characteristics
@ 125°C**

**Fig. 4. Dependence of $V_{CE(sat)}$ on
Junction Temperature**

**Fig. 5. Collector-to-Emitter Voltage
vs. Gate-to-Emitter Voltage**

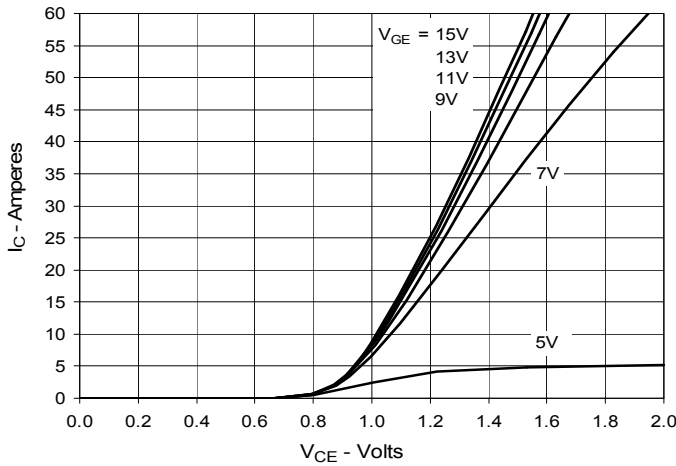
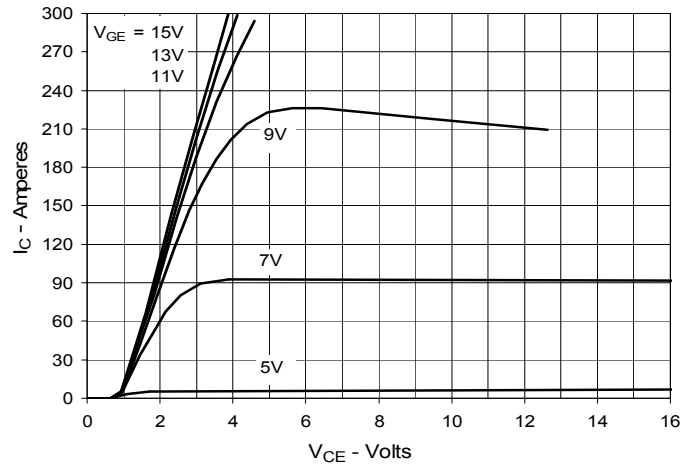
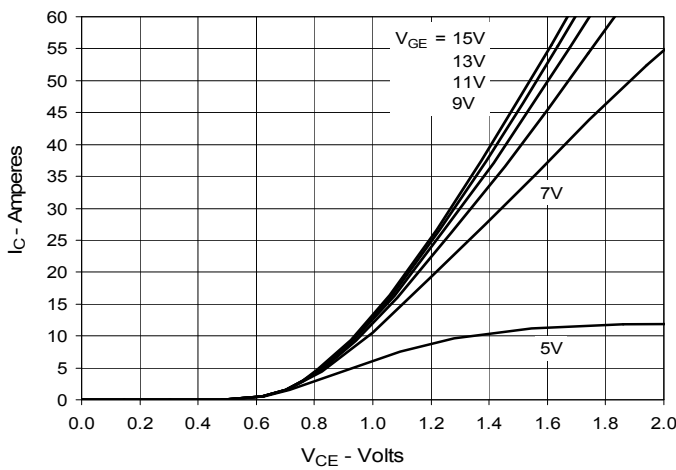
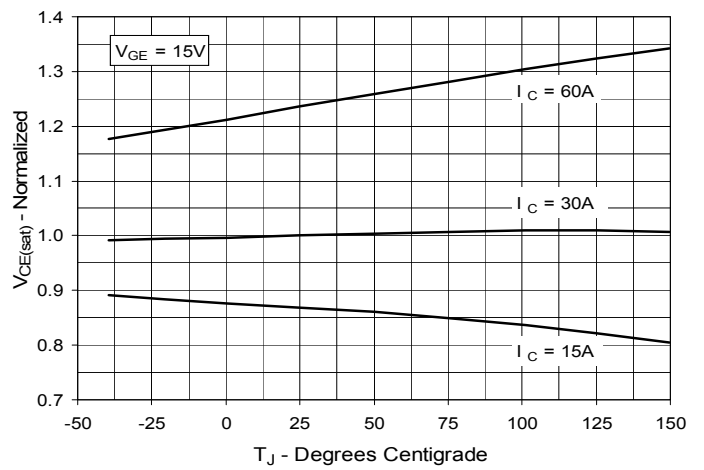
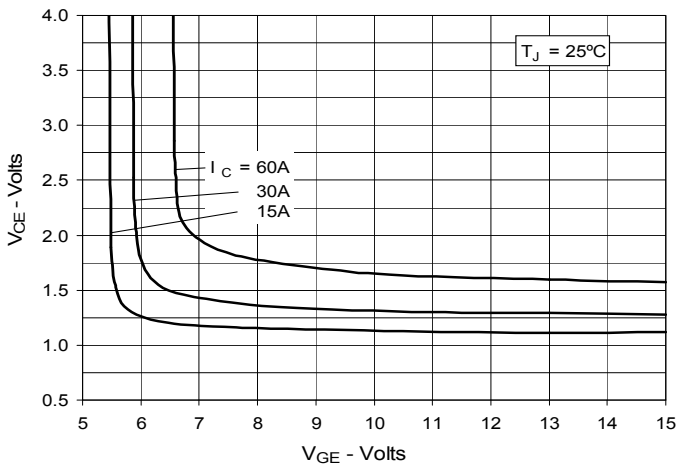
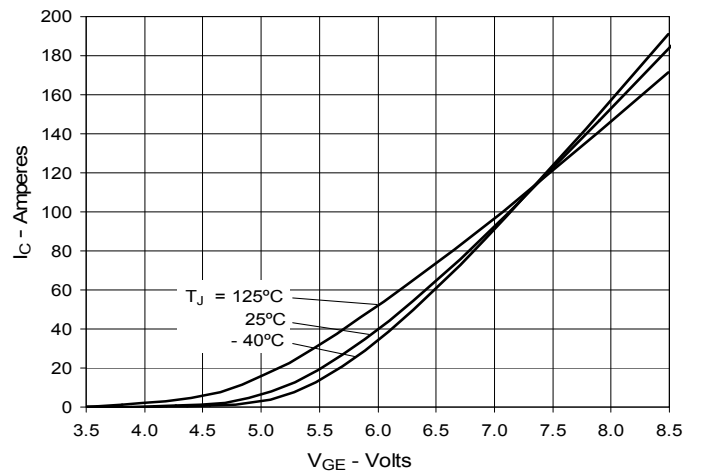
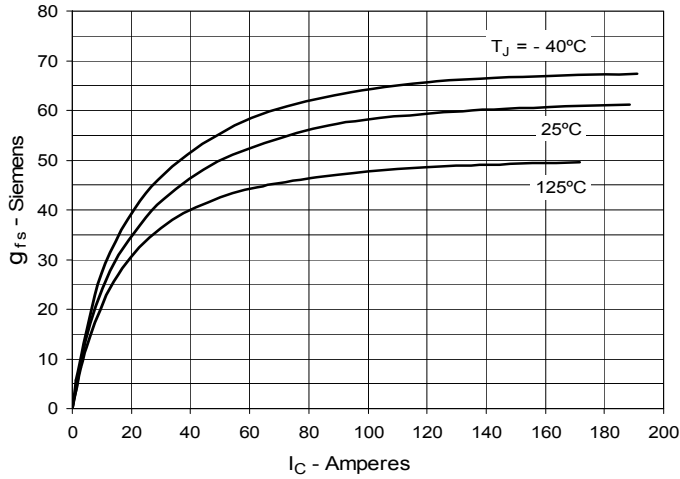
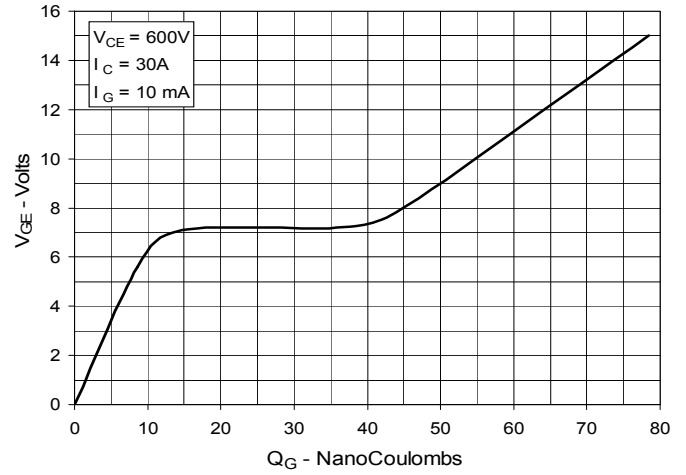
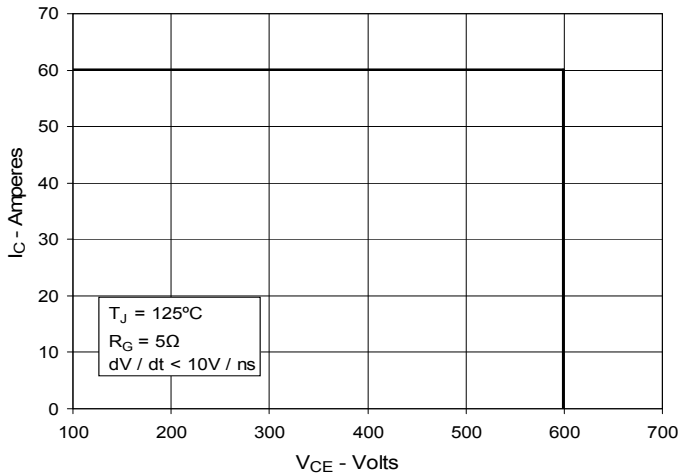
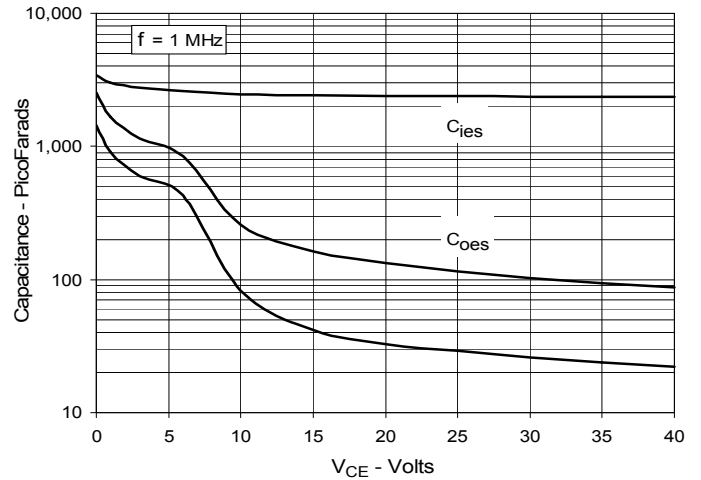
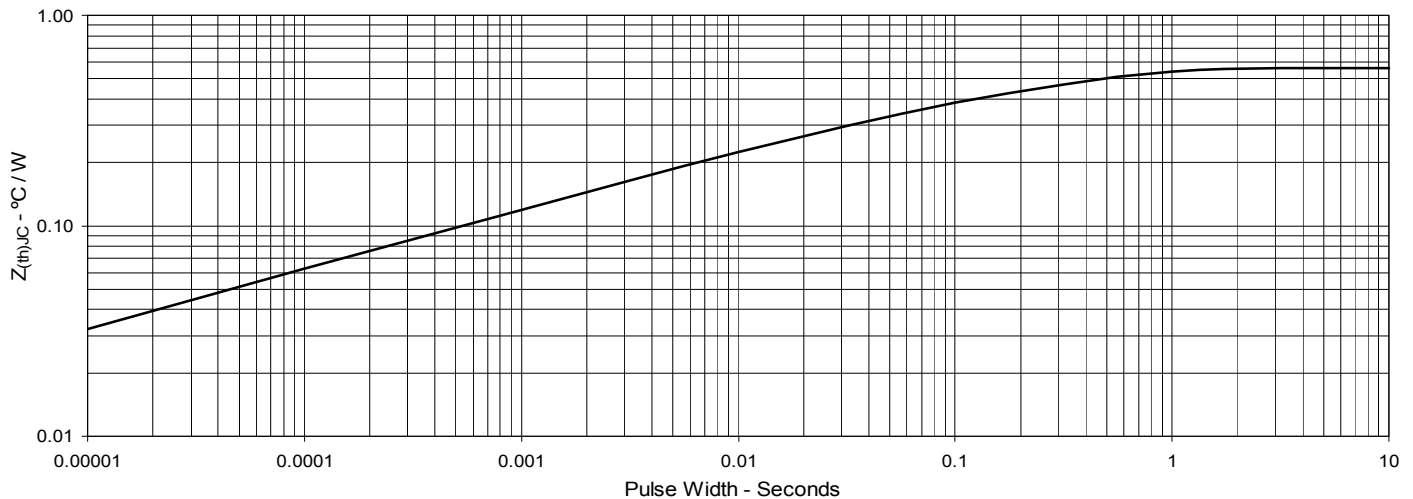
Fig. 6. Input Admittance

Fig. 7. Transconductance

Fig. 17. Gate Charge

Fig. 19. Reverse-Bias Safe Operating Area

Fig. 18. Capacitance

Fig. 11. Maximum Transient Thermal Impedance

IXYS reserves the right to change limits, test conditions and dimensions.

Fig. 12. Inductive Switching Energy Loss vs. Gate Resistance

Fig. 13. Inductive Switching Energy Loss vs. Junction Temperature

Fig. 14. Inductive Switching Energy Loss vs. Collector Current

Fig. 15. Inductive Turn-off Switching Times vs. Gate Resistance

Fig. 16. Inductive Turn-off Switching Times vs. Collector Current

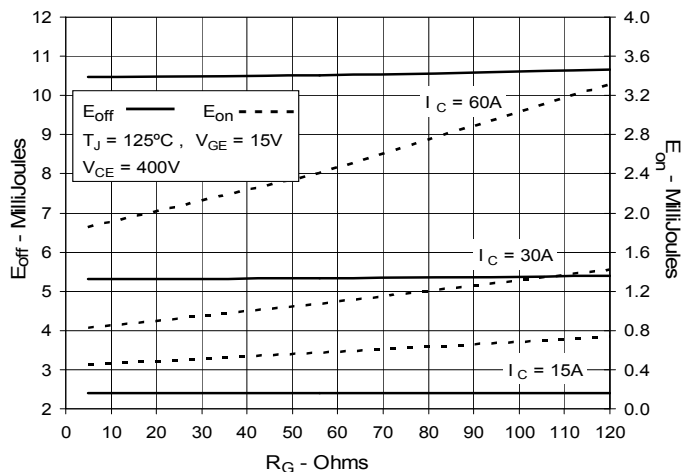
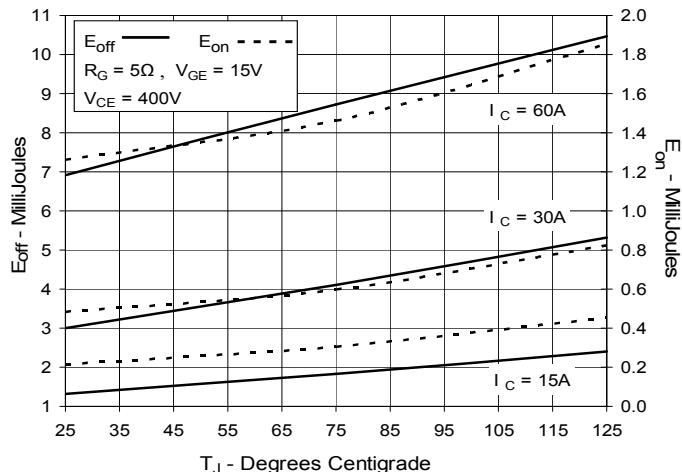
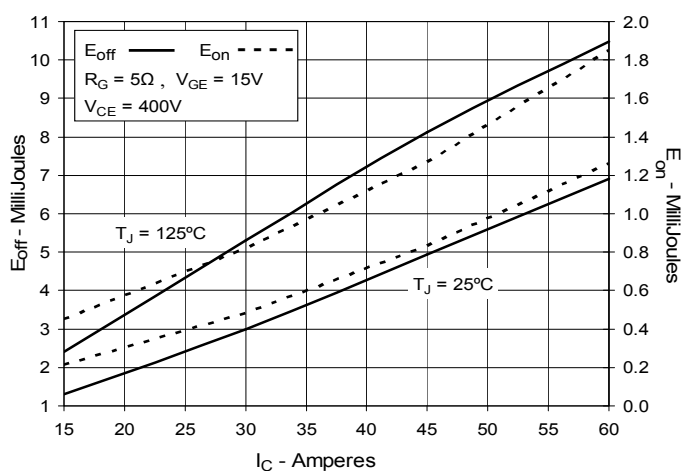
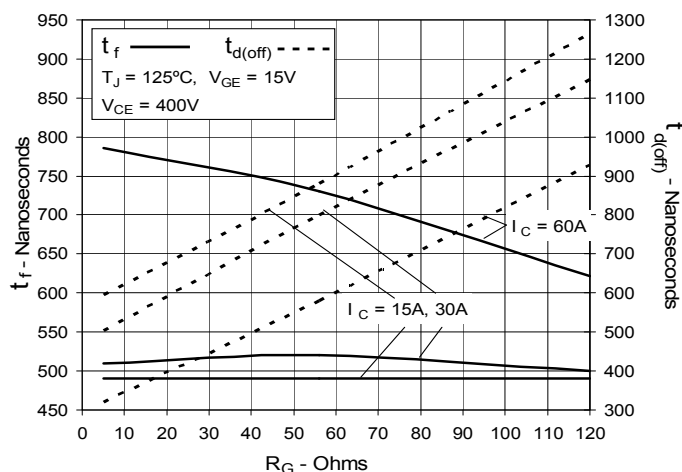
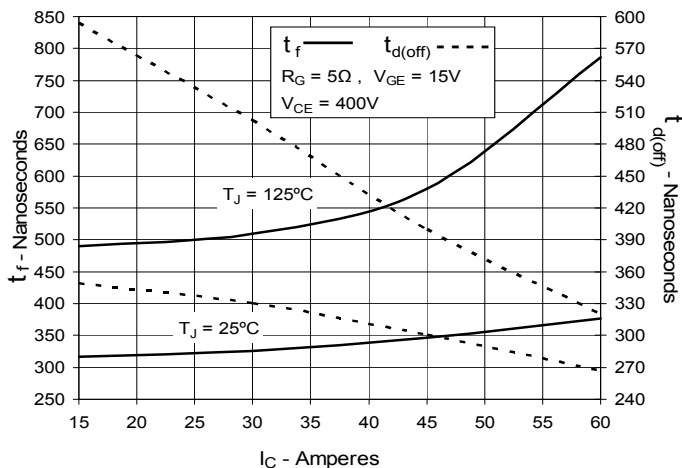
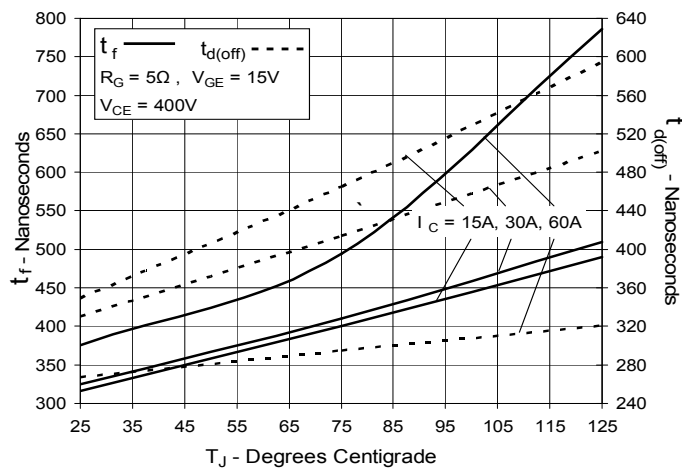
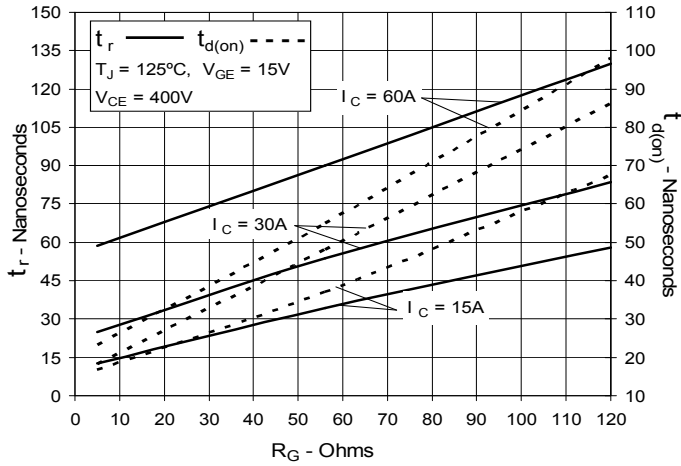
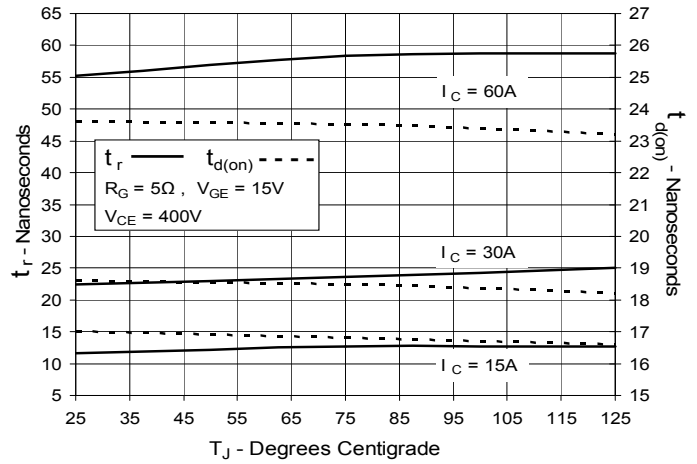
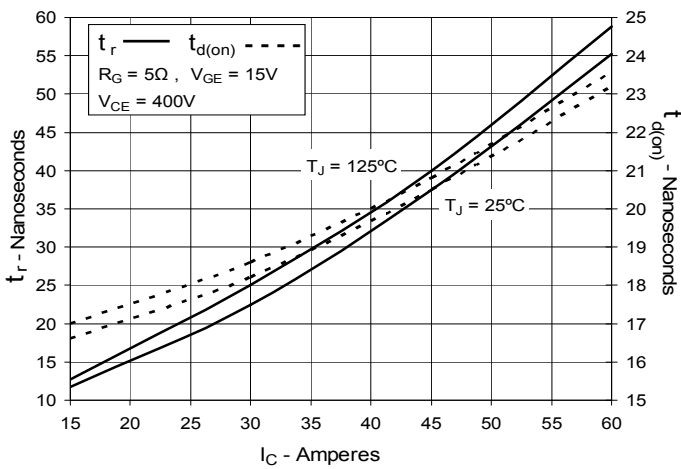
Fig. 17. Inductive Turn-off Switching Times vs. Junction Temperature

Fig. 18. Inductive Turn-on Switching Times vs. Gate Resistance

Fig. 19. Inductive Turn-on Switching Times vs. Junction Temperature

Fig. 20. Inductive Turn-on Switching Times vs. Collector Current

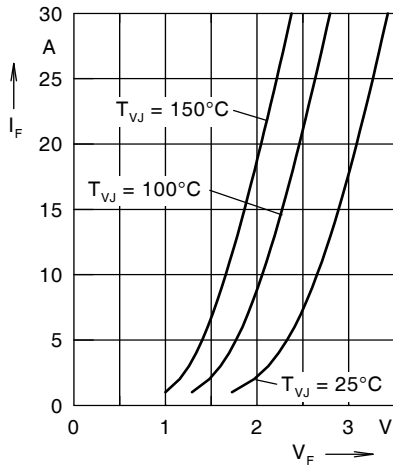
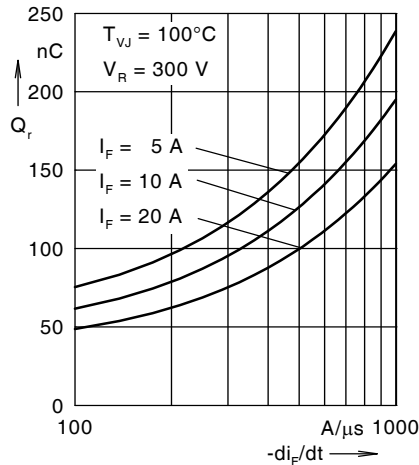
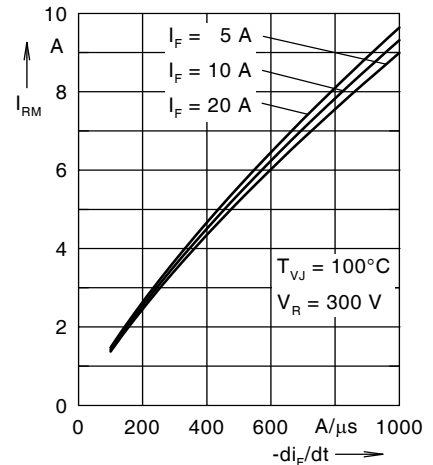
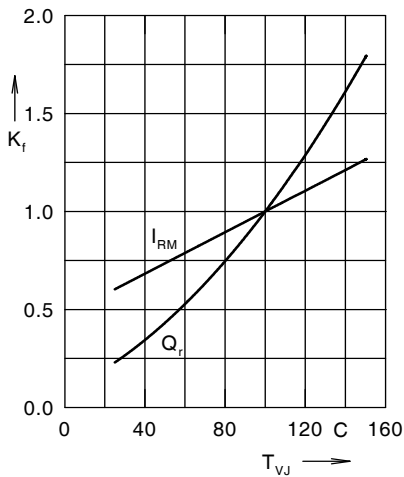
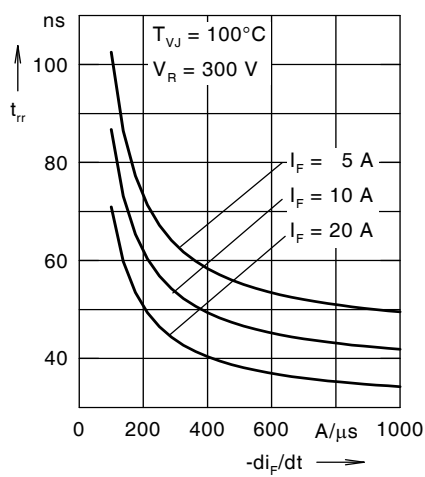
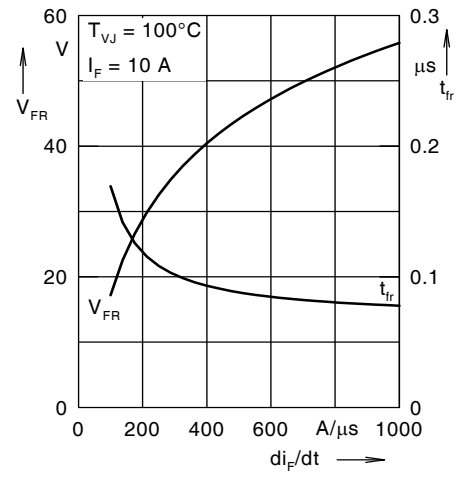
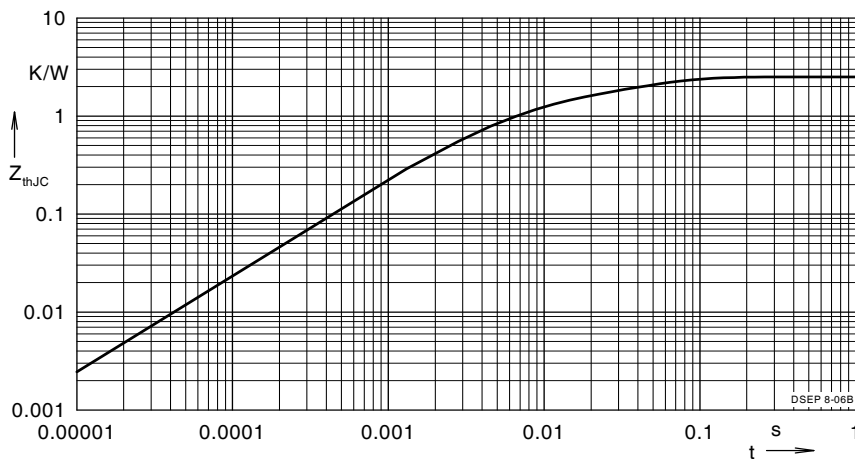

 Fig. 21. Forward current I_F versus V_F

 Fig. 22. Reverse recovery charge Q_r

 Fig. 23. Peak reverse current I_{RM}

 Fig. 24. Dynamic parameters Q_r , I_{RM}

 Fig. 25. Recovery time t_{rr} versus $-di_F/dt$

 Fig. 26. Peak forward voltage V_{FR} and t_{rr}

Fig. 27. Transient thermal resistance junction-to-case

 Constants for Z_{thJC} calculation:

i	R_{thi} (K/W)	t_i (s)
1	1.449	0.0052
2	0.5578	0.0003

NOTE: Fig. 2 to Fig. 6 shows typical values