

PolarHT™ Module

N-Channel Enhancement Mode

$V_{DSS} = 200\text{ V}$
 $I_{D80} = 1600\text{ A}$
 $R_{DS(on)} = 1.7\text{ m}\Omega\text{ max.}$

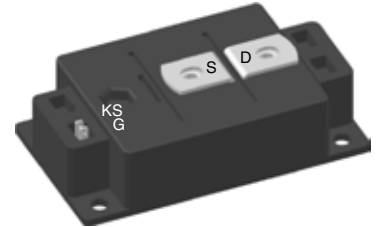
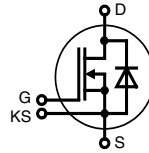

MOSFET			
Symbol	Conditions	Maximum Ratings	
V_{DSS}	$T_{VJ} = 25^\circ\text{C to } 150^\circ\text{C}$	200	V
V_{GS}		± 20	V
I_{D25}	$T_C = 25^\circ\text{C}$	1900	A
I_{D80}	$T_C = 80^\circ\text{C}$	1600	A
I_{F25}	$T_C = 25^\circ\text{C (diode)}$	1900	A
I_{F80}	$T_C = 80^\circ\text{C (diode)}$	1600	A

Features

- PolarHT™ technology
 - low $R_{DS(on)}$
 - dv/dt ruggedness
 - fast intrinsic reverse diode
- Package
 - low inductive current path
 - screw connection to high current main terminals
 - use of non interchangeable connectors for auxiliary terminals possible
 - Kelvin source terminals for easy drive
 - isolated ceramic base plate

Symbol	Conditions	Characteristic Values					
		$(T_{VJ} = 25^\circ\text{C, unless otherwise specified})$					
		min.	typ.	max.			
$R_{DS(on)}$	$V_{GS} = 10\text{ V}; I_D = 1600\text{ A};$ $T_{VJ} = 25^\circ\text{C}$ $T_{VJ} = 125^\circ\text{C}$		1.58 3.25	1.7 3.6	$\text{m}\Omega$ $\text{m}\Omega$		
$V_{GS(th)}$	$V_{DS} = 20\text{ V}; I_D = 5\text{ mA}$	2.5		5	V		
I_{DSS}	$V_{DS} = V_{DSS}; V_{GS} = 0\text{ V};$ $T_{VJ} = 25^\circ\text{C}$ $T_{VJ} = 125^\circ\text{C}$		5.0	0.5	mA mA		
I_{GSS}	$V_{GS} = \pm 20\text{ V}; V_{DS} = 0\text{ V}$			2	μA		
Q_g Q_{gs} Q_{gd}	$V_{GS} = 10\text{ V}; V_{DS} = 0.5 \cdot V_{DSS}; I_D = I_{D80}$		2900 600 1600		nC nC nC		
$t_{d(on)}$ t_r $t_{d(off)}$ t_f E_{on} E_{off} E_{rec}		inductive load $V_{GS} = 10\text{ V}; V_{DS} = 100\text{ V}$ $I_D = 1600\text{ A}; R_G = 1.8\ \Omega$ $T_{VJ} = 25^\circ\text{C}$		320 1220 620 700 24 152 3.7		ns ns ns ns mJ mJ mJ	
$t_{d(on)}$ t_r $t_{d(off)}$ t_f E_{on} E_{off} E_{rec}			inductive load $V_{GS} = 10\text{ V}; V_{DS} = 100\text{ V}$ $I_D = 1600\text{ A}; R_G = 1.8\ \Omega$ $T_{VJ} = 125^\circ\text{C}$		340 1220 740 580 28 147 4.9		ns ns ns ns mJ mJ mJ
R_{thJC} R_{thJH}	with heat transfer paste				0.037 0.056	0.03 0.056	K/W K/W

Applications

- converters with high power density for
 - main & aux. AC drives of electric vehicles
 - DC drives
 - power supplies

Source Drain Diode

Symbol	Conditions	Characteristic Values		
		min.	typ.	max.
V_{SD}	$I_F = 1600 \text{ A}; V_{GS} = 0 \text{ V};$	$T_{VJ} = 25^\circ\text{C}$	1.17	V
		$T_{VJ} = 125^\circ\text{C}$	1.13	V
t_{rr} Q_{rr} I_{RM}	$V_{DS} = 100 \text{ V}; I_F = 1600 \text{ A}$ $dV_F/dt = 1300 \text{ A}/\mu\text{s}$	$T_{VJ} = 25^\circ\text{C}$	340	ns
			40	μC
			210	A
t_{rr} Q_{rr} I_{RM}	$V_{DS} = 100 \text{ V}; I_F = 1600 \text{ A}$ $dV_F/dt = 1300 \text{ A}/\mu\text{s}$	$T_{VJ} = 125^\circ\text{C}$	380	ns
			56	μC
			250	A

Module

Symbol	Conditions	Maximum Ratings	
T_{VJ}		-40...+150	$^\circ\text{C}$
T_{stg}		-40...+125	$^\circ\text{C}$
V_{ISOL}	$I_{ISOL} \leq 1 \text{ mA}; 50/60 \text{ Hz}$	3600	V~
M_d	mounting torque (M6)	2.25 - 2.75	Nm
	terminal connection torque (M6)	4.5 - 5.5	Nm

Symbol	Conditions	Characteristic Values		
		min.	typ.	max.
Weight			250	g

Ordering	Part Name	Marking on Product	Delivering Mode	Base Qty	Code Key
Standard	VMO 1600-02P	VMO 1600-02P	Box	2	504288

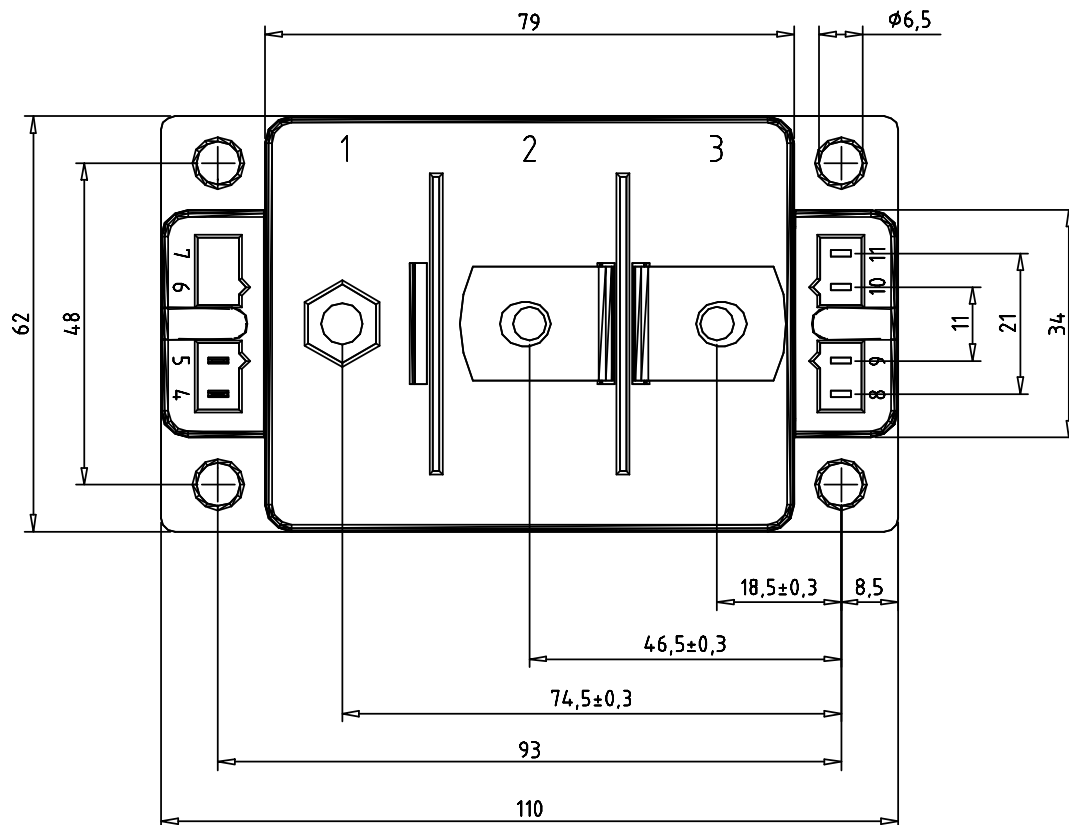
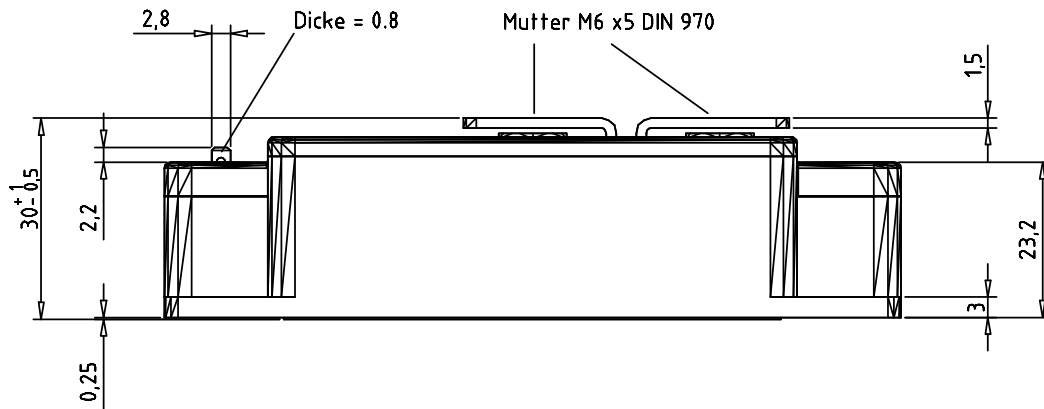
Optional accessories for modules
Dimensions in mm (1 mm = 0.0394")

keyed twin plugs
 (UL758, style 1385, CSA class 5851,
 guide 460-1-1)

- Type ZY180L with wire length 350 mm
 for pins 4 (Gate, yellow wire)
 and 5 (Kelvin Source, red wire)

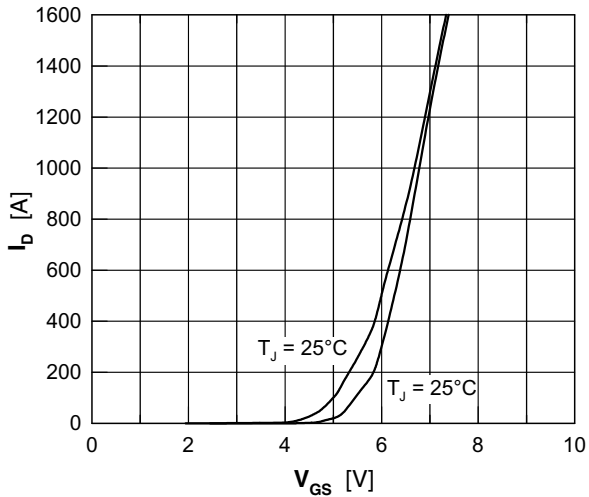

Fig. 1 Typical transfer characteristic

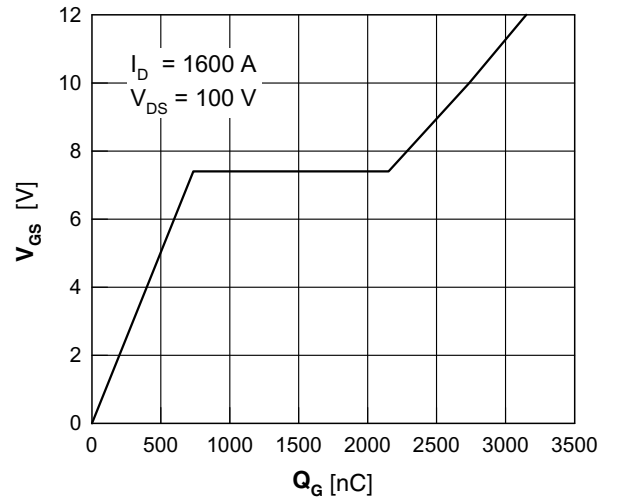

Fig. 2 Typical gate charge characteristic

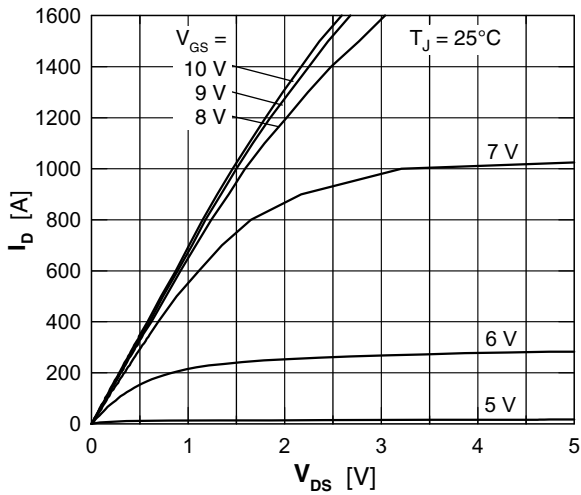

Fig. 3 Typical output characteristic

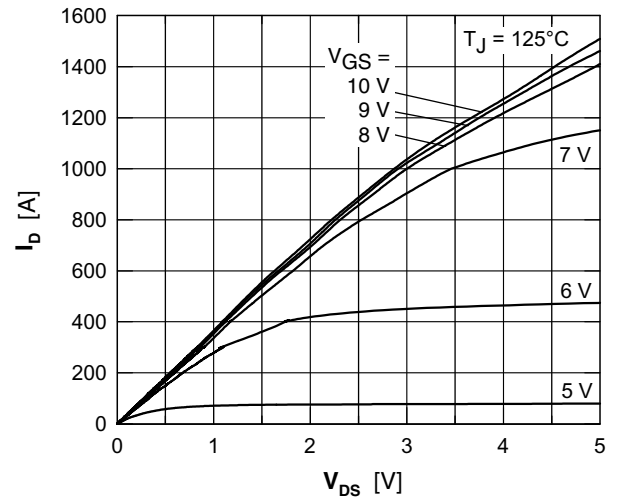

Fig. 4 Typical output characteristic

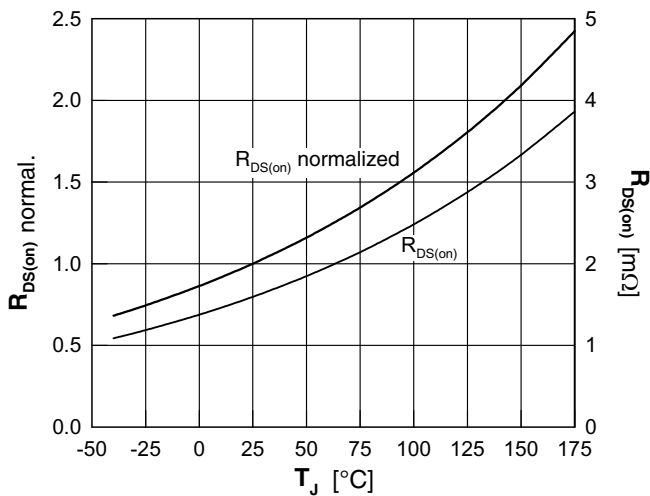

Fig. 5 Typ. drain source on-state resistance $R_{DS(on)}$ versus junction temperature T_{J}

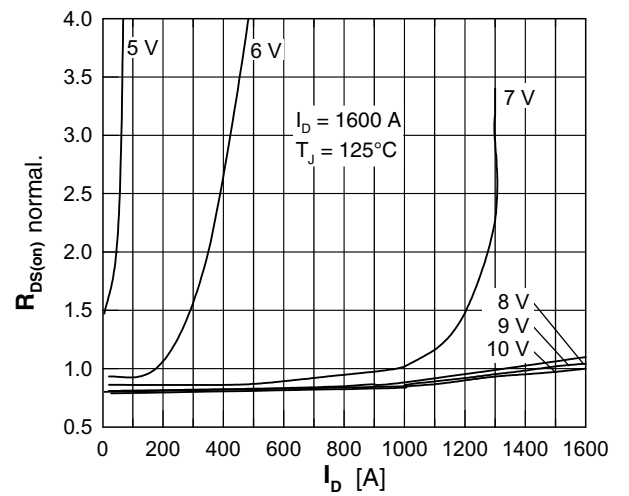

Fig. 6 Typ. drain source on-state resistance $R_{DS(on)}$ versus I_D

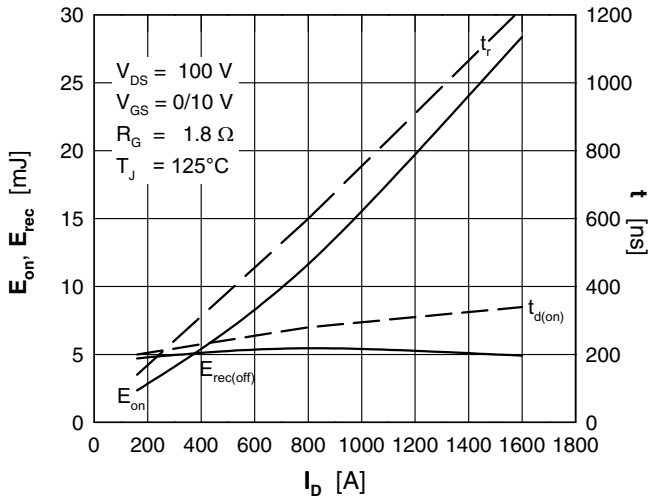

Fig.7 Typ. turn-on energy & switching times vs. drain source current, inductive switching

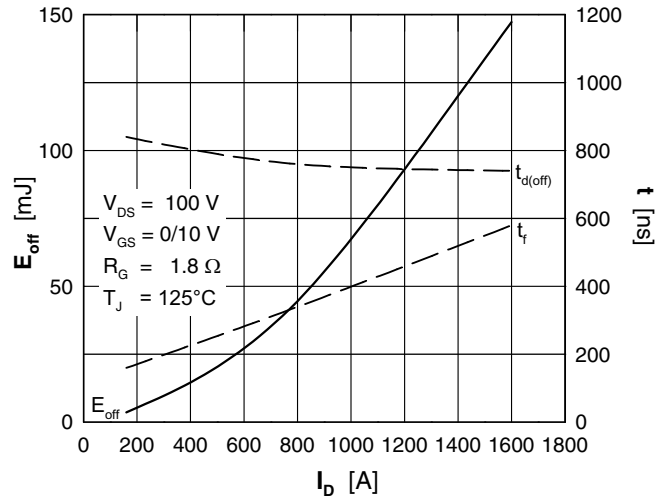

Fig. 8 Typ. turn-off energy & switching times vs. drain source current, inductive switching

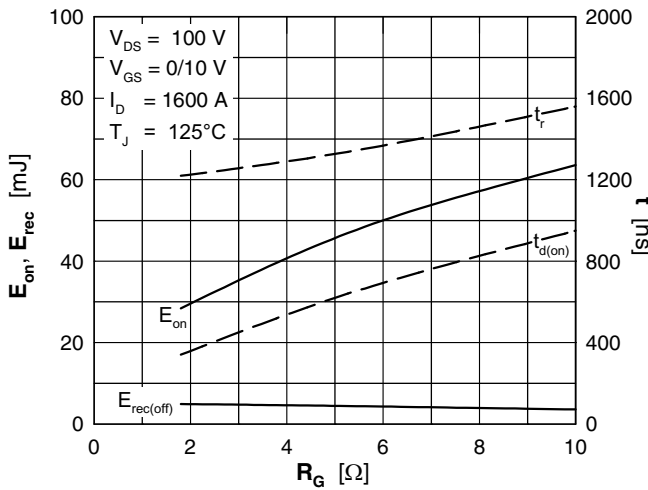

Fig. 9 Typ. turn-on energy & switching times vs. gate resistor, inductive switching

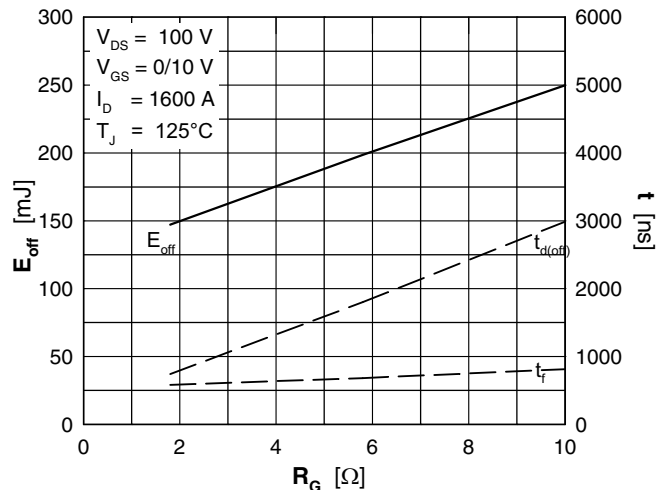
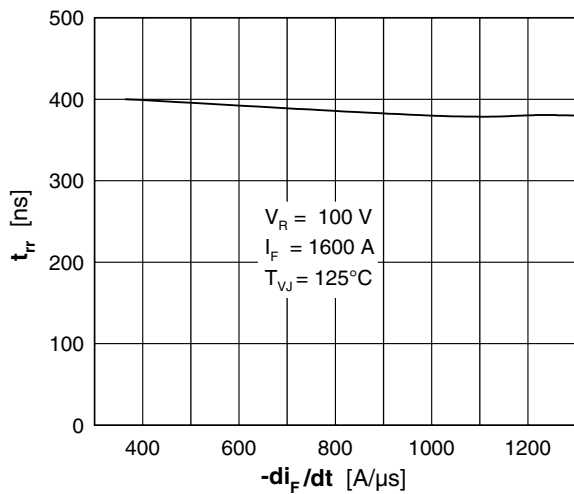
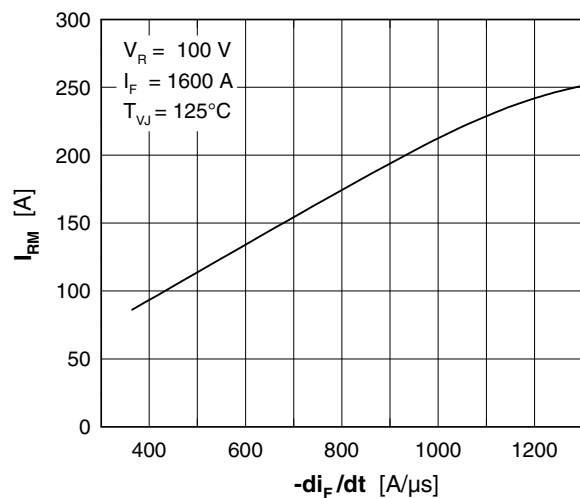

Fig. 10 Typ. turn-off energy & switching times vs. gate resistor, inductive switching

 Fig.11 Typ. reverse recovery time t_{rr} of the body diode versus di/dt

 Fig. 12 Typ. reverse recovery current I_{RM} of the body diode versus di/dt

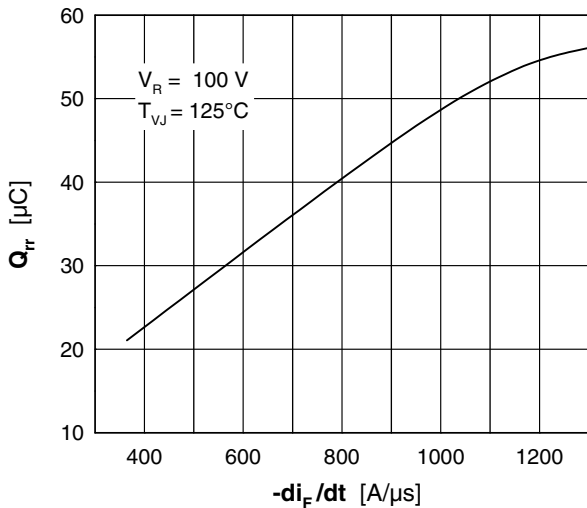

Fig. 13 Typical reverse recovery charge Q_{rr} of the body diode versus di/dt

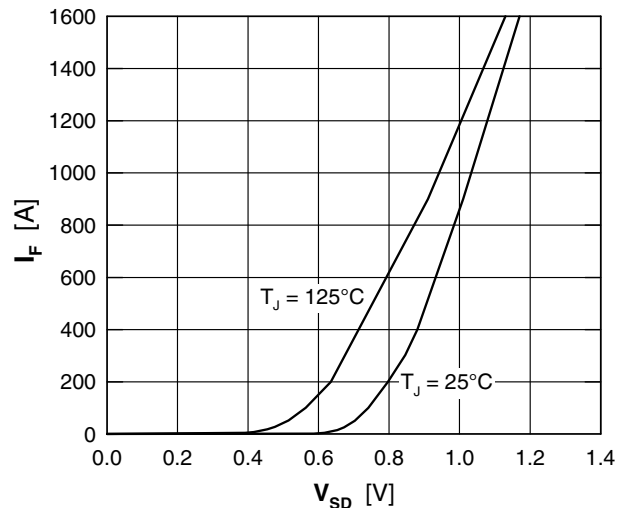

Fig. 14 Source drain current I_F (body diode) vs. typical source drain voltage V_{SD}

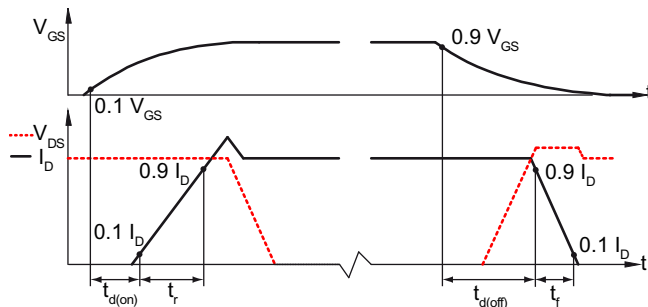

Fig. 15 Definition of switching times

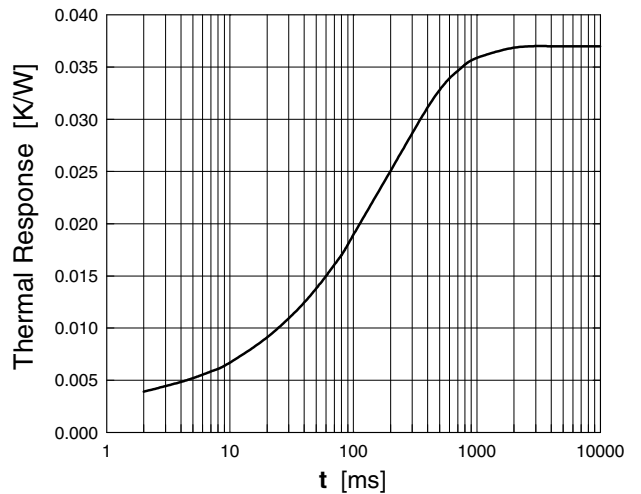

Fig. 16 Typ. thermal impedance junction to heatsink $Z_{th,JH}$ with heat transfer paste