

Three phase full Bridge

with Trench MOSFETs
in DCB isolated high current package

$V_{DSS} = 75 \text{ V}$
 $I_{D25} = 110 \text{ A}$
 $R_{DSon \text{ typ.}} = 4.0 \text{ m}\Omega$

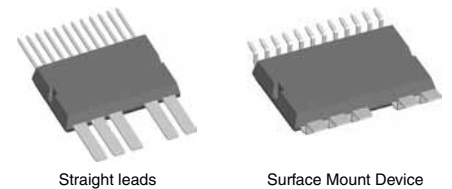
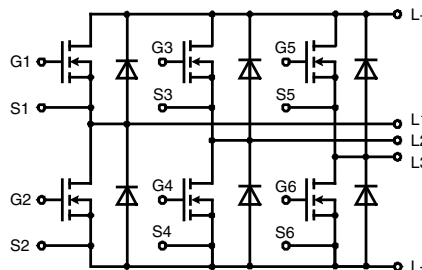

MOSFETs			
Symbol	Conditions	Maximum Ratings	
V_{DSS}	$T_{VJ} = 25^\circ\text{C to } 150^\circ\text{C}$	75	V
V_{GS}		± 20	V
I_{D25}	$T_C = 25^\circ\text{C}$	110	A
I_{D90}	$T_C = 90^\circ\text{C}$	85	A
I_{F25}	$T_C = 25^\circ\text{C (diode)}$	110	A
I_{F90}	$T_C = 90^\circ\text{C (diode)}$	80	A

Applications

AC drives

- in automobiles
 - electric power steering
 - starter generator
- in industrial vehicles
 - propulsion drives
 - fork lift drives
- in battery supplied equipment

Features

- MOSFETs in trench technology:
 - low R_{DSon}
 - optimized intrinsic reverse diode
- package:
 - high level of integration
 - high current capability 300 A max.
 - aux. terminals for MOSFET control
 - terminals for soldering or welding connections
 - isolated DCB ceramic base plate with optimized heat transfer
- Space and weight savings

Package options

- 2 lead forms available
 - straight leads (SL)
 - SMD lead version (SMD)

Symbol	Conditions	Characteristic Values				
		$(T_{VJ} = 25^\circ\text{C, unless otherwise specified})$				
		min.	typ.	max.		
R_{DSon}	on chip level at $V_{GS} = 10 \text{ V}; I_D = 60 \text{ A}$	$T_{VJ} = 25^\circ\text{C}$		4.0	4.9	$\text{m}\Omega$
		$T_{VJ} = 125^\circ\text{C}$		7.2	8.4	$\text{m}\Omega$
$V_{GS(th)}$	$V_{DS} = 20 \text{ V}; I_D = 1 \text{ mA}$	2		4	V	
I_{DSS}	$V_{DS} = V_{DSS}; V_{GS} = 0 \text{ V}$		0.1	1	μA mA	
I_{GSS}	$V_{GS} = \pm 20 \text{ V}; V_{DS} = 0 \text{ V}$			0.2	μA	
Q_g	$V_{GS} = 10 \text{ V}; V_{DS} = 36 \text{ V}; I_D = 25 \text{ A}$		115		nC	
Q_{gs}			30		nC	
Q_{gd}			30		nC	
$t_{d(on)}$	$V_{GS} = 10 \text{ V}; V_{DS} = 30 \text{ V}$ $I_D = 80 \text{ A}; R_G = 39 \Omega$ inductive load $T_{VJ} = 125^\circ\text{C}$		130		ns	
t_r			100		ns	
$t_{d(off)}$			500		ns	
t_f			100		ns	
E_{on}			0.20		mJ	
E_{off}		0.50		mJ		
E_{recoff}		0.01		mJ		
R_{thJC}				1.0	K/W	
R_{thJH}	with heat transfer paste (IXYS test setup)		1.3	1.6	K/W	

Source-Drain Diode

Symbol	Conditions	Characteristic Values			
		min.	typ.	max.	
($T_J = 25^\circ\text{C}$, unless otherwise specified)					
V_{SD}	(diode) $I_F = 80\text{ A}$; $V_{GS} = 0\text{ V}$		0.9	1.2	V
t_{rr}	$I_F = 80\text{ A}$; $-di_F/dt = 800\text{ A}/\mu\text{s}$ $V_R = 30\text{ V}$; $T_J = 125^\circ\text{C}$		55		ns
Q_{RM}			0.9		μC
I_{RM}			30		A

Component

Symbol	Conditions	Maximum Ratings	
I_{RMS}	per pin in main current paths (P+, N-, L1, L2, L3) may be additionally limited by external connections	300	A
T_{VJ}		-55...+175	$^\circ\text{C}$
T_{stg}		-55...+125	$^\circ\text{C}$
V_{ISOL}	$I_{ISOL} \leq 1\text{ mA}$, 50/60 Hz, $f = 1\text{ minute}$	1000	V~
F_C	mounting force with clip	50 - 250	N

Symbol	Conditions	Characteristic Values			
		min.	typ.	max.	
$R_{pin\ to\ chip}$	with heatsink compound		0.6		$\text{m}\Omega$
C_p	coupling capacity between shorted pins and mounting tab in the case		160		pF
Weight	typ.		25		g

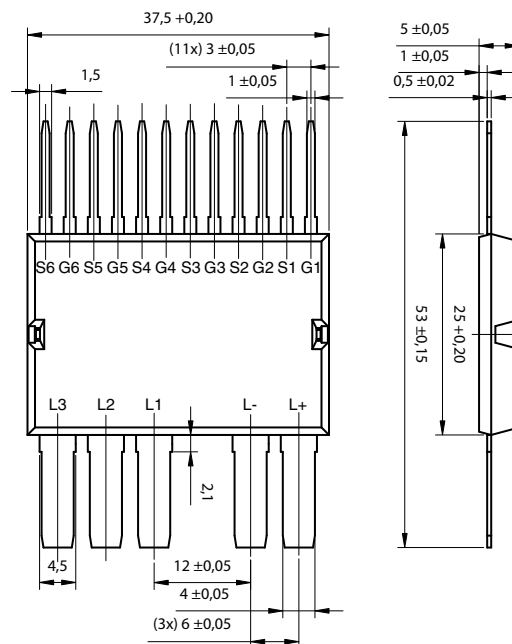
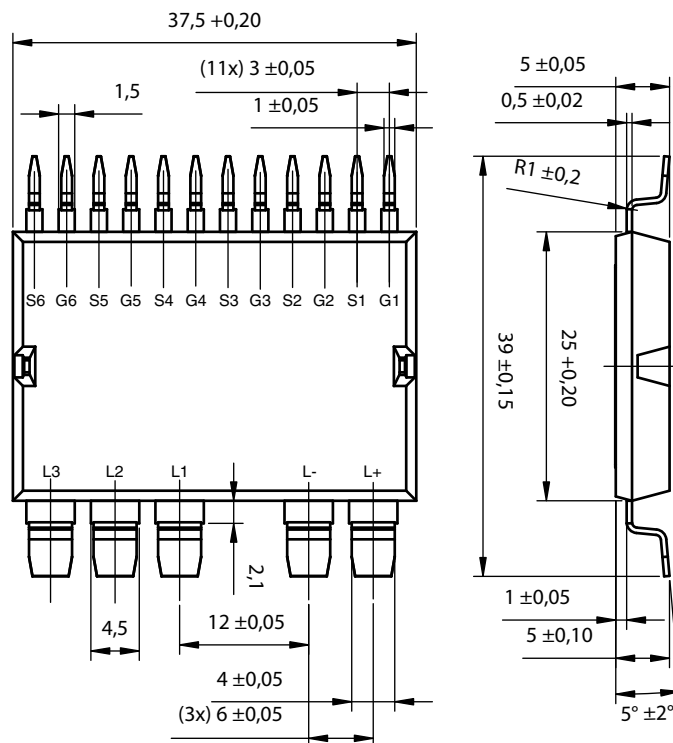
Straight Leads GWM 120-0075X1-SL

Surface Mount Device GWM 120-0075X1-SMD

Leads	Ordering	Part Name & Packing Unit Marking	Part Marking	Delivering Mode	Base Qty.	Ordering Code
Straight	Standard	GWM 120-0075X1 - SL	GWM 120-0075X1	Blister	28	505 960
SMD	Standard	GWM 120-0075X1 - SMD	GWM 120-0075X1	Blister	28	505 581

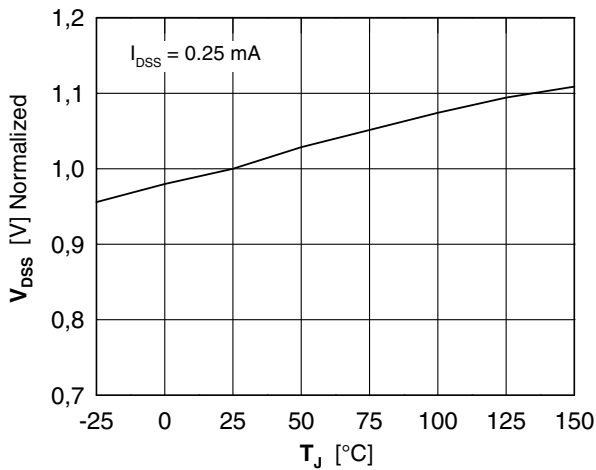

Fig. 1 Drain source breakdown voltage V_{DSS} vs. junction temperature T_J

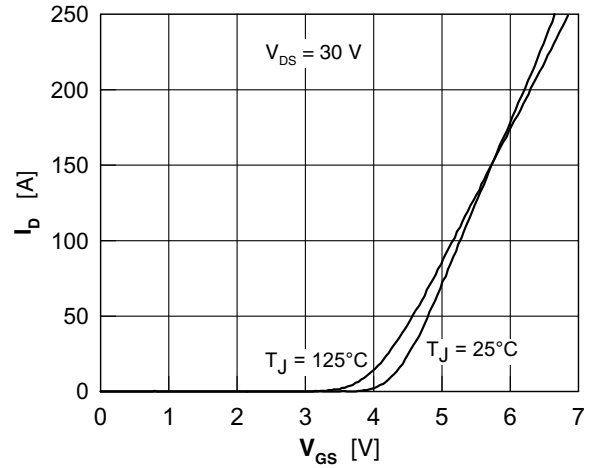

Fig. 2 Typical transfer characteristic

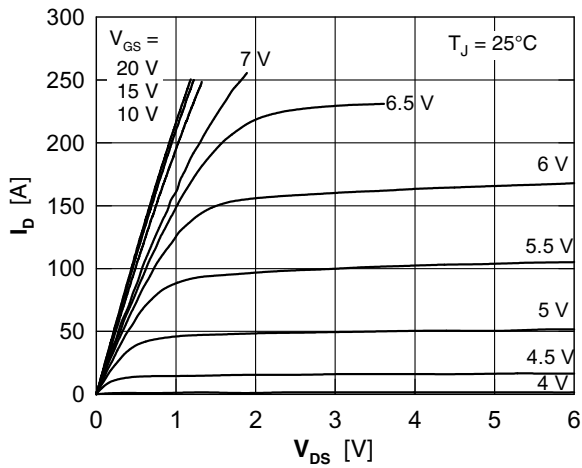

Fig. 3 Typical output characteristic

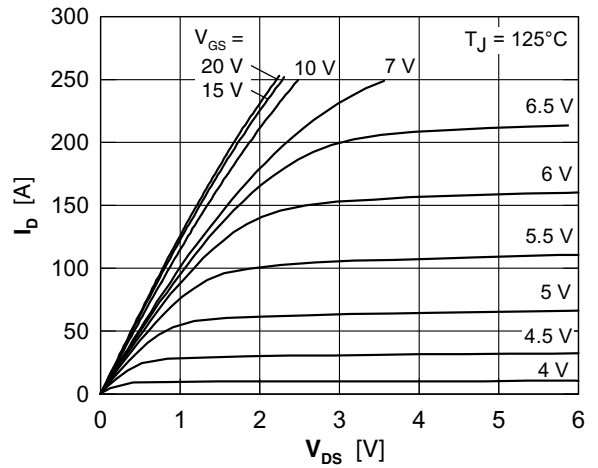

Fig. 4 Typical output characteristic

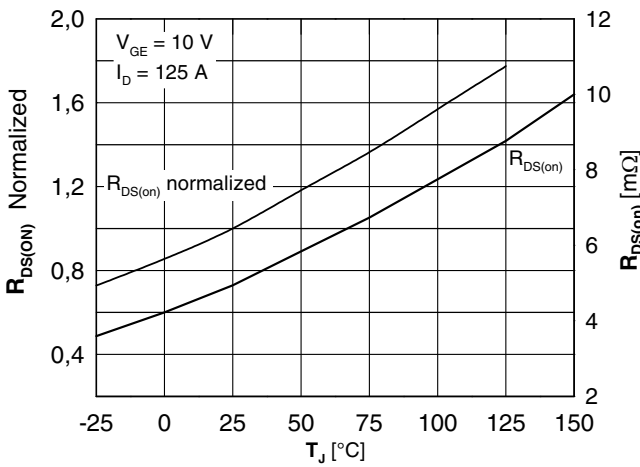

Fig. 5 Drain source on-state resistance $R_{DS(on)}$ versus junction temperature T_J

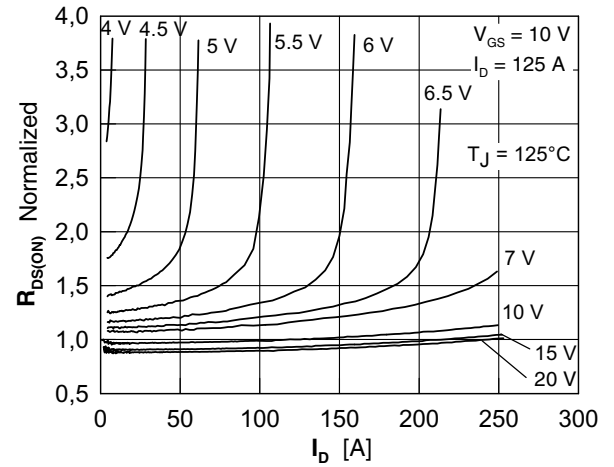

Fig. 6 Drain source on-state resistance $R_{DS(on)}$ versus I_D

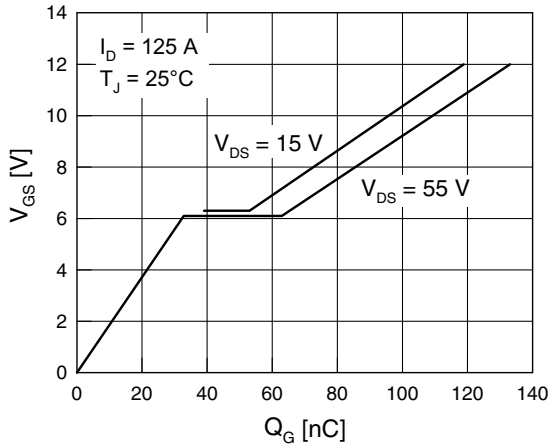

Fig. 7 Gate charge characteristic

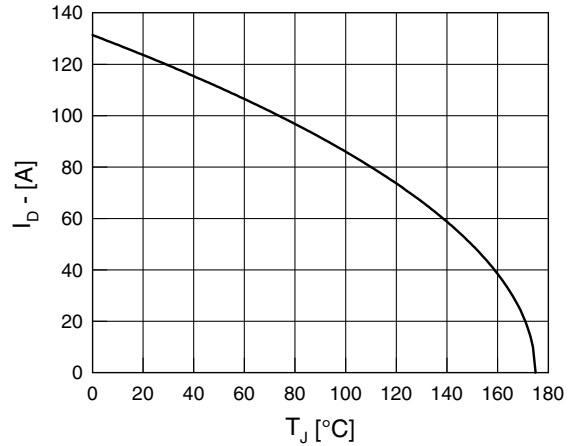

Fig. 8 Drain current I_D vs. case temperature T_C

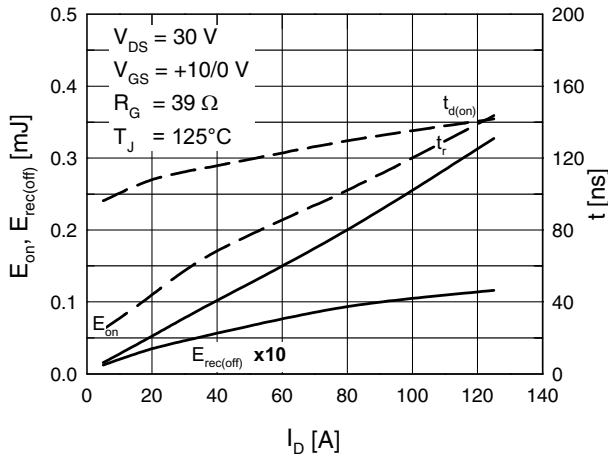

Fig. 9 Typ. turn-on energy & switching times vs. collector current, inductive switching

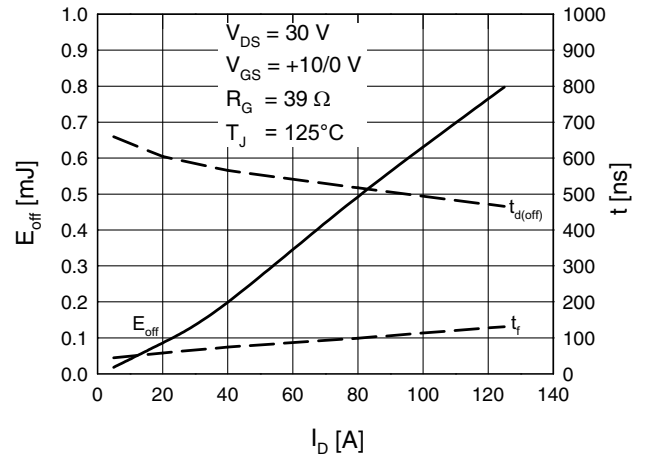

Fig. 10 Typ. turn-off energy & switching times vs. collector current, inductive switching

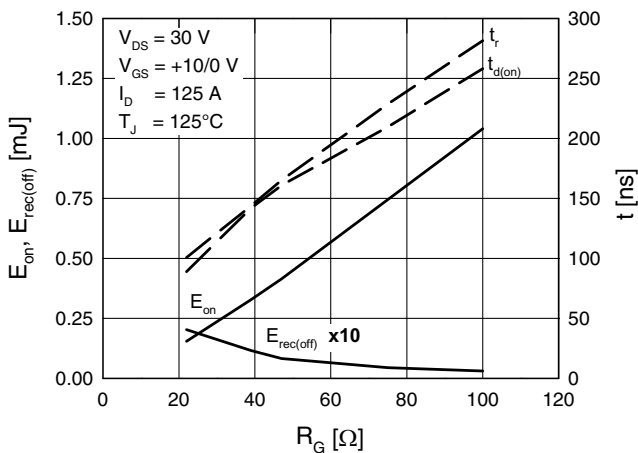

Fig. 11 Typ. turn-on energy & switching times vs. gate resistor, inductive switching

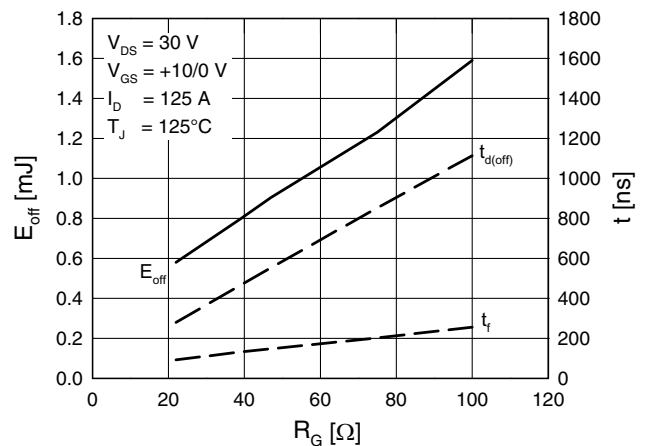

Fig. 12 Typ. turn-off energy & switching times vs. gate resistor, inductive switching

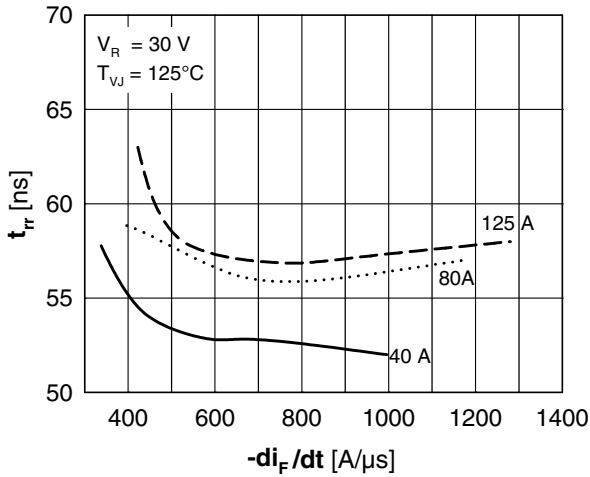

Fig. 13 Reverse recovery time t_{rr} of the body diode vs. di/dt

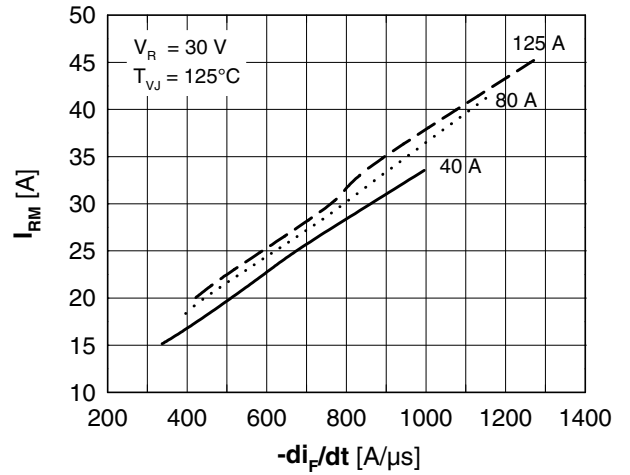

Fig. 14 Reverse recovery current I_{RRM} of the body diode vs. di/dt

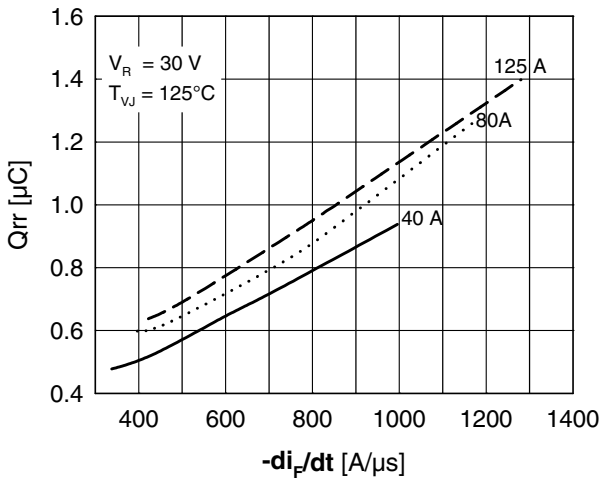

Fig. 15 Reverse recovery charge Q_{rr} of the body diode vs. di/dt

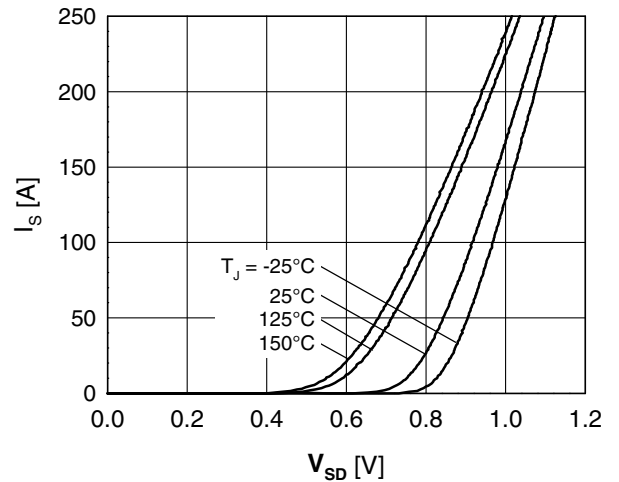

Fig. 16 Source current I_S vs. source drain voltage V_{SD} (body diode)

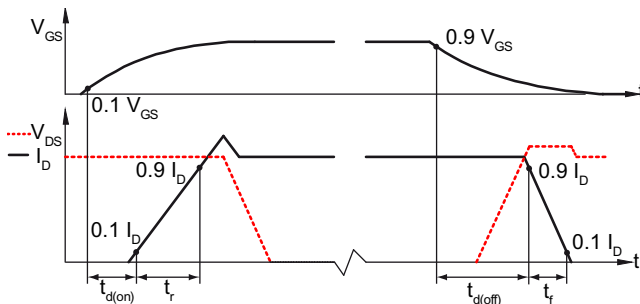

Fig. 17 Definition of switching times

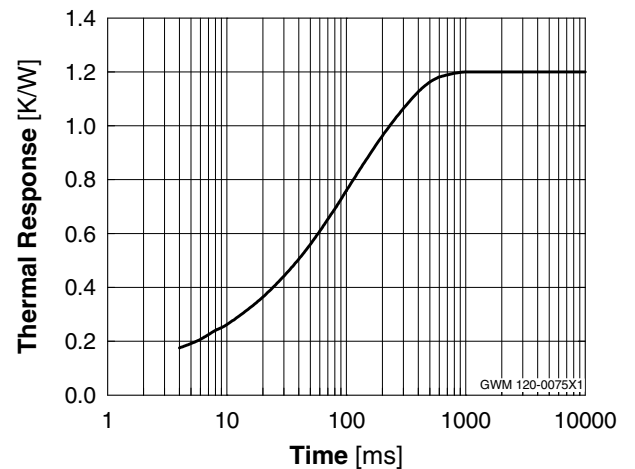

Fig. 18 Typ. therm. impedance junction to heatsink Z_{thJC}