

# Three phase full Bridge

with Trench MOSFETs  
in DCB isolated high current package

$V_{DSS} = 40 \text{ V}$   
 $I_{D25} = 180 \text{ A}$   
 $R_{DSon \text{ typ.}} = 1.9 \text{ m}\Omega$

Preliminary data

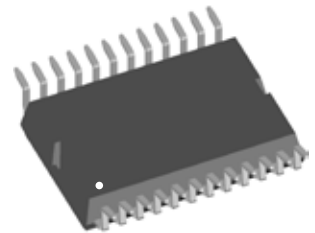
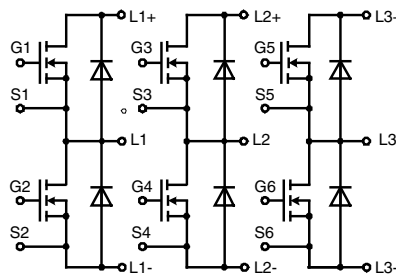

MOSFETs		Maximum Ratings	
Symbol	Conditions		
$V_{DSS}$	$T_{VJ} = 25^{\circ}\text{C to } 150^{\circ}\text{C}$	40	V
$V_{GS}$		$\pm 20$	V
$I_{D25}$	$T_C = 25^{\circ}\text{C}$	180	A
$I_{D90}$	$T_C = 90^{\circ}\text{C}$	136	A
$I_{D110}$	$T_C = 110^{\circ}\text{C}$	120	A
$I_{F25}$	$T_C = 25^{\circ}\text{C}$ (diode)	182	A
$I_{F90}$	$T_C = 90^{\circ}\text{C}$ (diode)	112	A
$I_{F110}$	$T_C = 110^{\circ}\text{C}$ (diode)	88	A

## Applications

AC drives

- in automobiles
  - electric power steering
  - starter generator
- in industrial vehicles
  - propulsion drives
  - fork lift drives
- in battery supplied equipment

## Features

- MOSFETs in trench technology:
  - low  $R_{DSon}$
  - optimized intrinsic reverse diode
- package:
  - high level of integration
  - high current capability
  - aux. terminals for MOSFET control
  - terminals for soldering or welding connections
  - isolated DCB ceramic base plate with optimized heat transfer
- Space and weight savings

Symbol	Conditions	Characteristic Values			
		$(T_{VJ} = 25^{\circ}\text{C}, \text{ unless otherwise specified})$			
		min.	typ.	max.	
$R_{DSon}^{1)}$	on chip level at $V_{GS} = 10 \text{ V}$		1.9	2.5	$\text{m}\Omega$
			2.8	5.3	$\text{m}\Omega$
$V_{GS(th)}$	$V_{DS} = 20 \text{ V}; I_D = 1 \text{ mA}$	2.5		4.5	V
$I_{DSS}$	$V_{DS} = V_{DSS}; V_{GS} = 0 \text{ V}$		50	5	$\mu\text{A}$
					$\mu\text{A}$
$I_{GSS}$	$V_{GS} = \pm 20 \text{ V}; V_{DS} = 0 \text{ V}$			0.2	$\mu\text{A}$
$Q_g$	$V_{GS} = 10 \text{ V}; V_{DS} = 20 \text{ V}; I_D = 100 \text{ A}$		110		nC
$Q_{gs}$			33		nC
$Q_{gd}$			30		nC
$t_{d(on)}$	inductive load $V_{GS} = +10/0 \text{ V}; V_{DS} = 15 \text{ V}$ $I_D = 135 \text{ A}; R_G = 39 \Omega;$ $T_J = 125^{\circ}\text{C}$		150		ns
$t_r$			240		ns
$t_{d(off)}$			350		ns
$t_f$			170		ns
$E_{on}$			0.12		mJ
$E_{off}$		0.51		mJ	
$E_{recoff}$		0.003		mJ	
$R_{thJC}$			1.3	1.0	K/W
$R_{thJH}$	with heat transfer paste (IXYS test setup)		1.3	1.6	K/W

<sup>1)</sup>  $V_{DS} = I_D \cdot (R_{DS(on)} + R_{Pin \text{ to Chip}})$

**Source-Drain Diode**

Symbol	Conditions	Characteristic Values			
		min.	typ.	max.	
(T <sub>J</sub> = 25°C, unless otherwise specified)					
V <sub>SD</sub>	(diode) I <sub>F</sub> = 100 A; V <sub>GS</sub> = 0 V		0.9	1.2	V
t <sub>rr</sub>	I <sub>F</sub> = 100 A; -di <sub>F</sub> /dt = 600 A/μs V <sub>R</sub> = 15 V; T <sub>J</sub> = 125°C		38		ns
Q <sub>RM</sub>			0.31		μC
I <sub>RM</sub>			14		A

**Component**

Symbol	Conditions	Maximum Ratings	
I <sub>RMS</sub>	per pin in main current paths (P+, N-, L1, L2, L3) may be additionally limited by external connections 2 pins for output L1, L2, L3	75	A
T <sub>J</sub>		-55...+175	°C
T <sub>stg</sub>		-55...+125	°C
V <sub>ISOL</sub>	I <sub>ISOL</sub> ≤ 1 mA, 50/60 Hz, f = 1 minute	1000	V~
F <sub>C</sub>	mounting force with clip	50 - 250	N

Symbol	Conditions	Characteristic Values		
		min.	typ.	max.
R <sub>pin to chip</sub> <sup>1)</sup>	L+ to L1/L2/L3 or L- to L1/L2/L3		0.9	mΩ
C <sub>P</sub>	coupling capacity between shorted pins and back side metallization		160	pF
Weight			25	g

<sup>1)</sup> V<sub>DS</sub> = I<sub>D</sub> · (R<sub>DS(on)</sub> + R<sub>Pin to Chip</sub>)

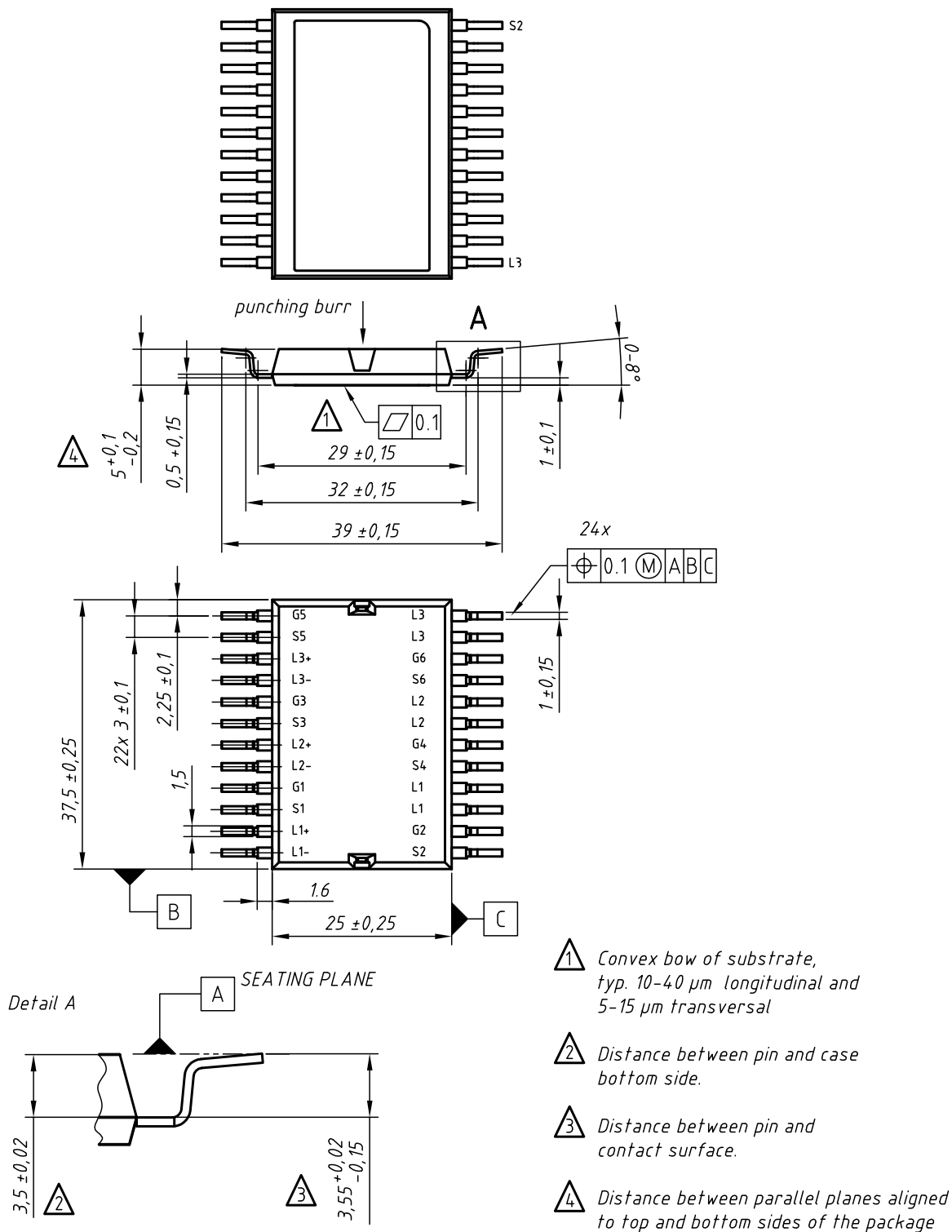

contact pin:

- galv. tin plating, per pin side: Sn 10...25  $\mu$ m, undercoating Ni 0,2...1  $\mu$ m
- stamping edges may be free of tin
- punching burr:  $\leq 0,05$ mm

Leads	Ordering	Part Name & Packing Unit Marking	Part Marking	Delivering Mode	Base Qty.	Ordering Code
SMD	Standard	GMM 3x180-004X2 - SMD	GMM 3x180-004X2	Blister	28	509042

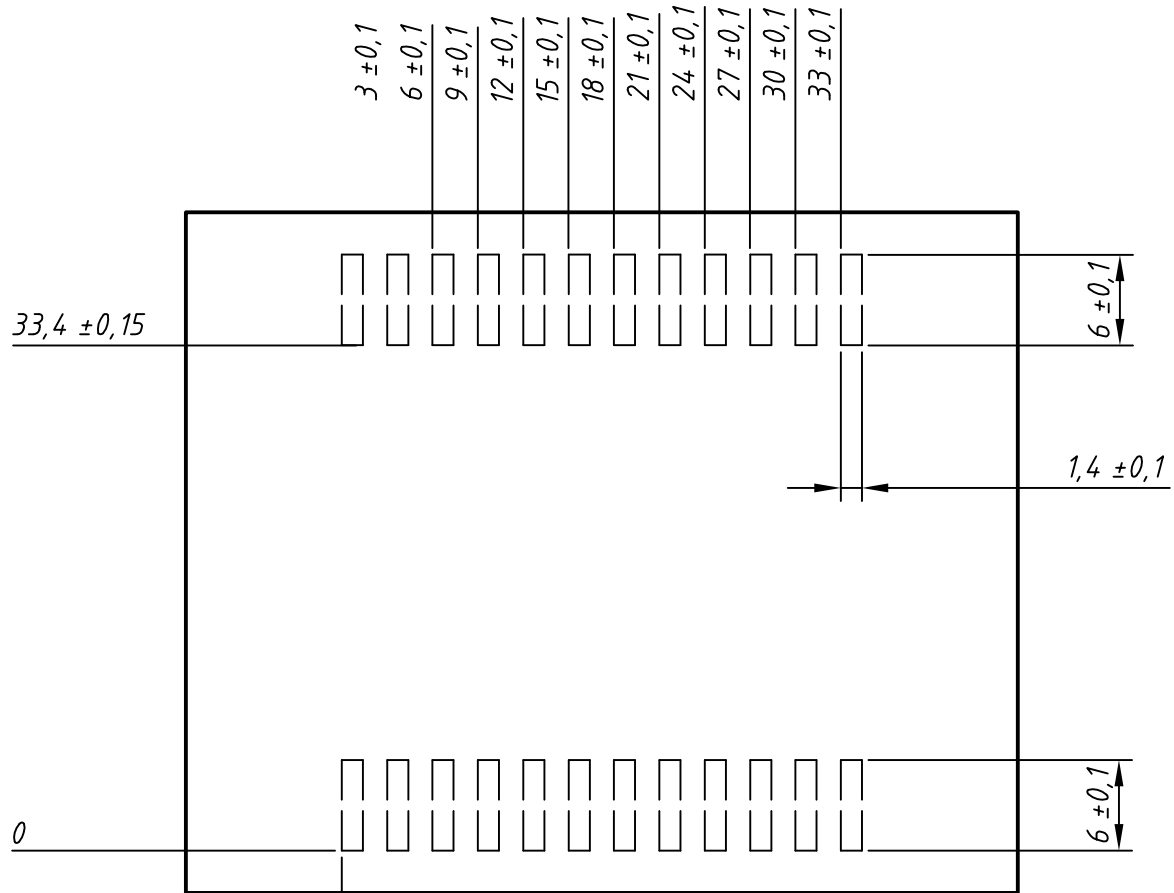

Remarks:

- 1) pin layout / dimensions are conditionally
- 2) soldering paste thickness: 200µm

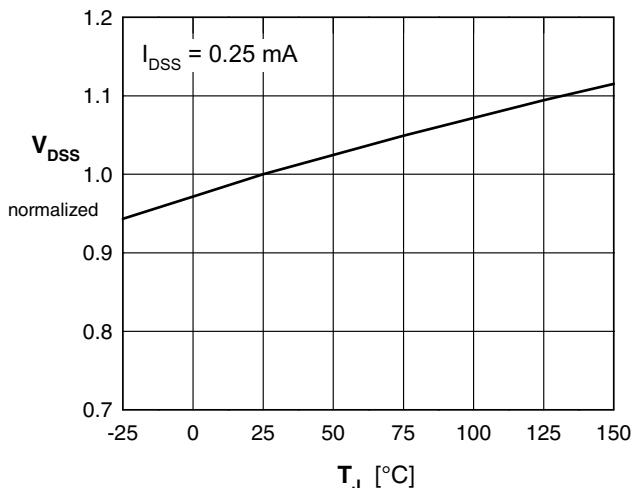

Fig. 1 Drain source breakdown voltage  $V_{DSS}$  vs. junction temperature  $T_{VJ}$

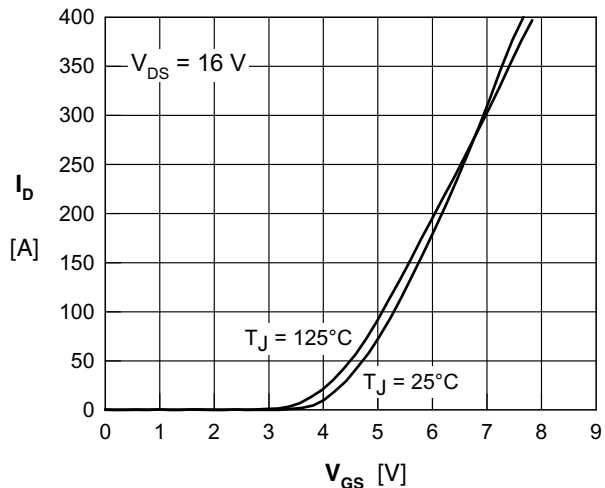

Fig. 2 Typical transfer characteristic

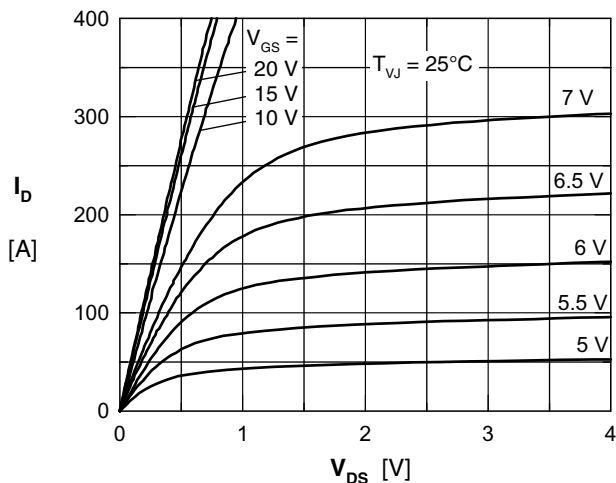

Fig. 3 Typical output characteristic

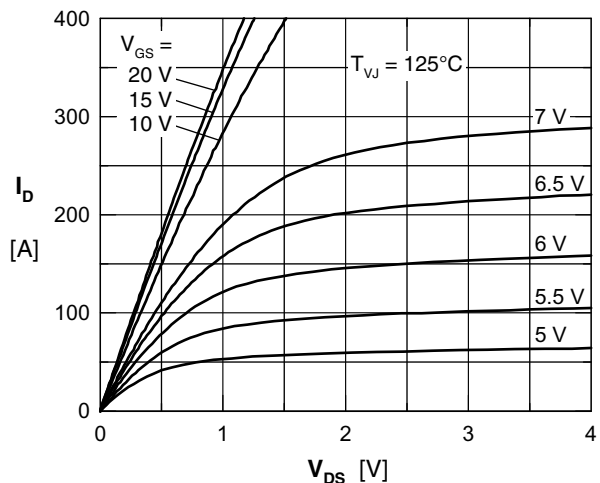

Fig. 4 Typical output characteristic

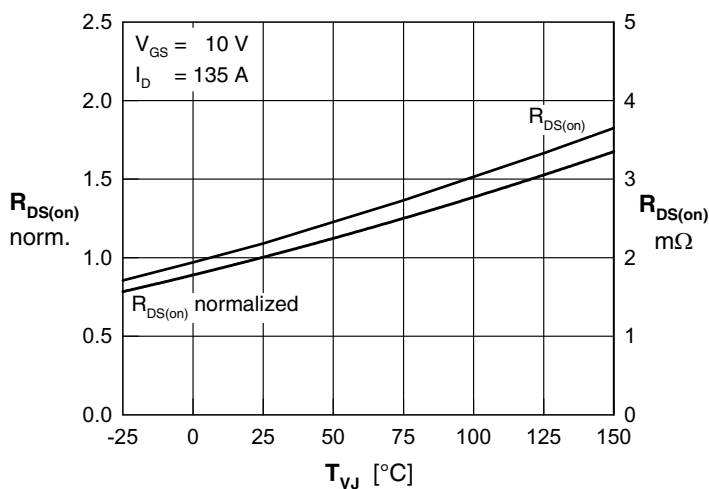

Fig. 5 Typ. drain source on-state resistance  $R_{DS(on)}$  versus junction temperature  $T_J$

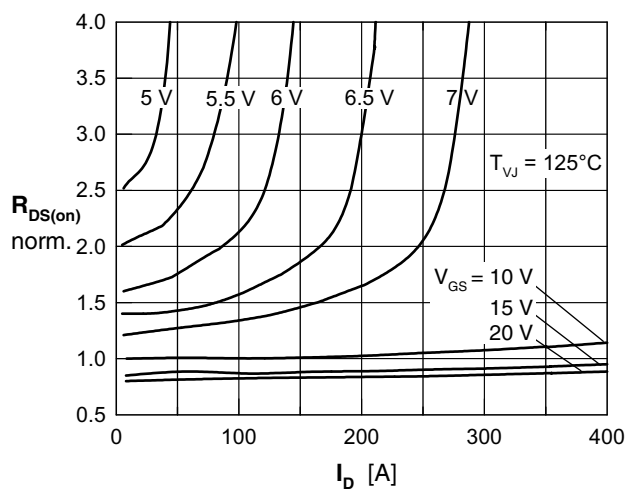

Fig. 6 Typ. drain source on-state resistance  $R_{DS(on)}$  versus  $I_b$

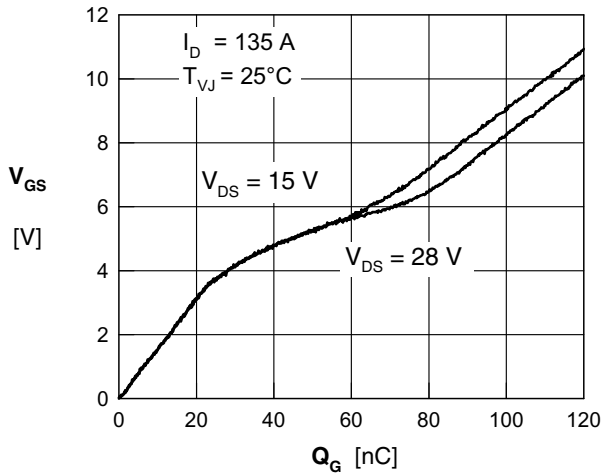

Fig. 7 Gate charge characteristics

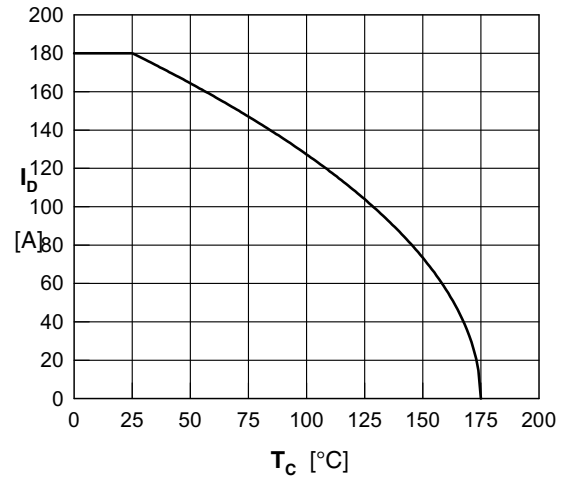

Fig. 8 Drain current  $I_D$  vs. temperature  $T_C$

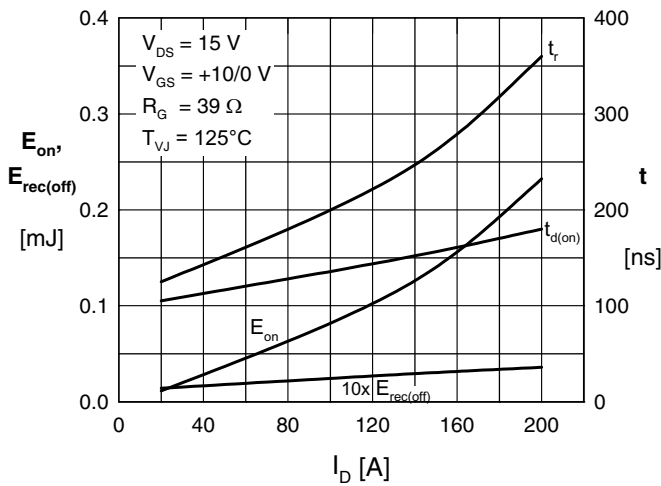

Fig. 9 Typ. turn-on energy & switching times vs. collector current, inductive switching

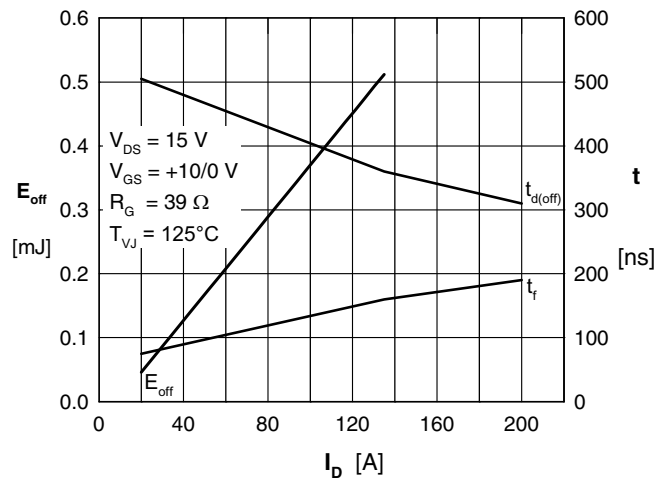

Fig. 10 Typ. turn-off energy & switching times vs. collector current, inductive switching

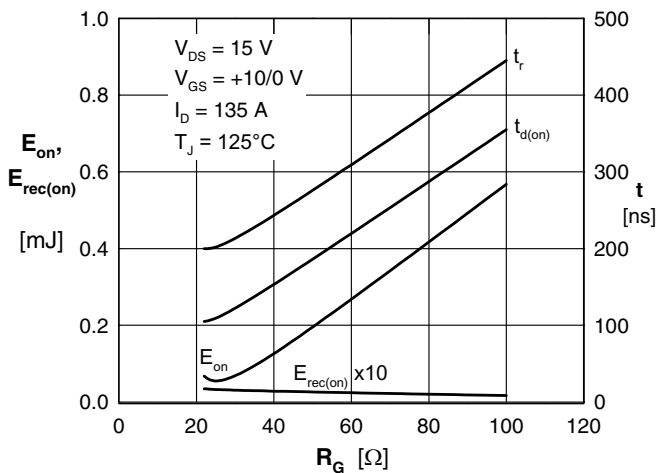

Fig. 11 Typ. turn-on energy & switching times vs. gate resistor, inductive switching

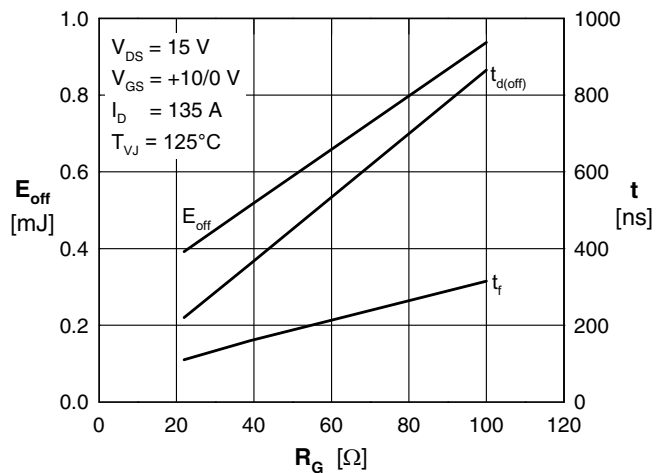

Fig. 12 Typ. turn-off energy & switching times vs. gate resistor, inductive switching

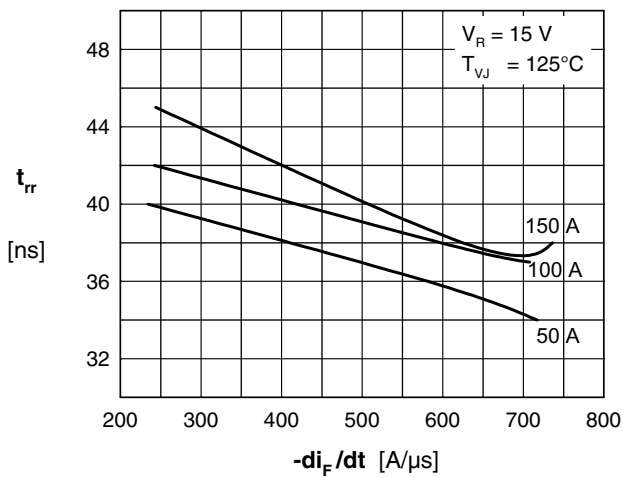

Fig. 13 Typ. reverse recovery time  $t_{rr}$  of the body diodes versus  $di/dt$

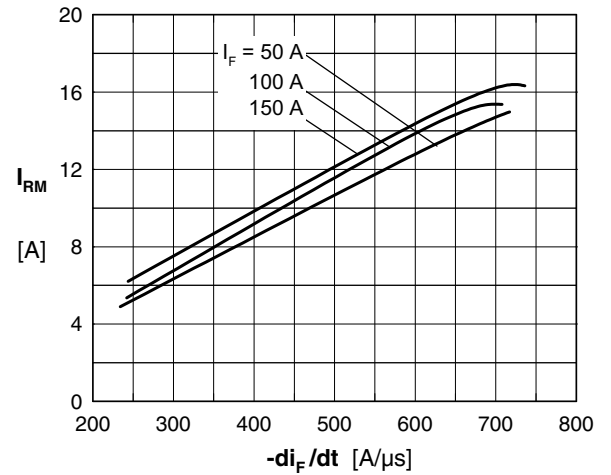

Fig. 14 Typ. reverse recovery current  $I_{RM}$  of the body diodes versus  $di/dt$

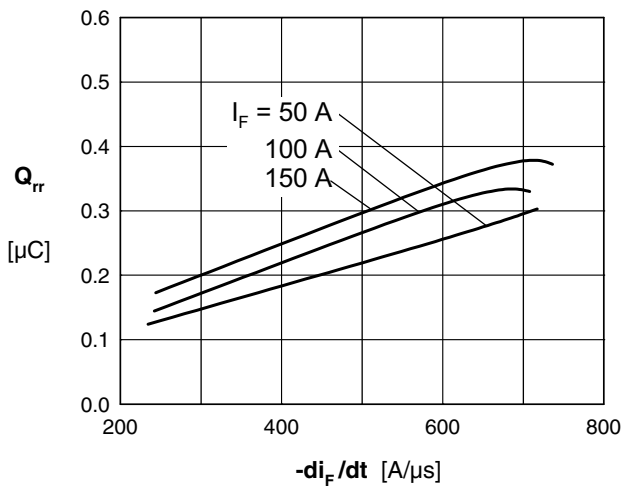

Fig. 15 Typ. reverse recovery charge  $Q_{rr}$  of the body diodes versus  $di/dt$

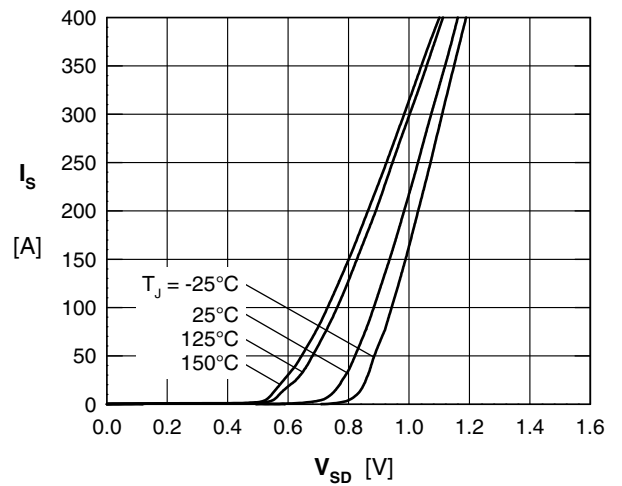

Fig. 16 Typ. source current  $I_s$  versus source drain voltage  $V_{SD}$  (body diode)

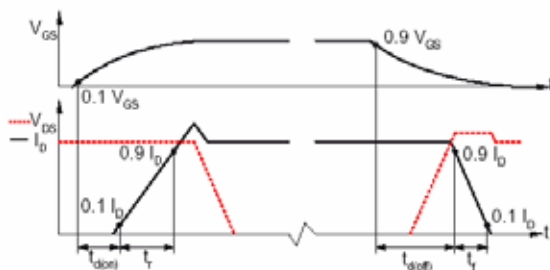

Fig. 17 Definition of switching times