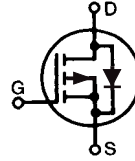

TrenchP™
Power MOSFET
IXTY26P10T
IXTA26P10T
IXTP26P10T
 $V_{DSS} = -100V$
 $I_{D25} = -26A$
 $R_{DS(on)} \leq 90m\Omega$

 P-Channel Enhancement Mode
 Avalanche Rated

| Symbol | Test Conditions | Maximum Ratings | |
|---------------|---|-----------------|------------|
| V_{DSS} | $T_J = 25^\circ C$ to $150^\circ C$ | -100 | V |
| V_{DGR} | $T_J = 25^\circ C$ to $150^\circ C$, $R_{GS} = 1M\Omega$ | -100 | V |
| V_{GSS} | Continuous | ± 15 | V |
| V_{GSM} | Transient | ± 25 | V |
| I_{D25} | $T_C = 25^\circ C$ | -26 | A |
| I_{DM} | $T_C = 25^\circ C$, Pulse Width Limited by T_{JM} | -80 | A |
| I_A | $T_C = 25^\circ C$ | -26 | A |
| E_{AS} | $T_C = 25^\circ C$ | 300 | mJ |
| P_D | $T_C = 25^\circ C$ | 150 | W |
| T_J | | -55 ... +150 | $^\circ C$ |
| T_{JM} | | 150 | $^\circ C$ |
| T_{stg} | | -55 ... +150 | $^\circ C$ |
| T_L | 1.6mm (0.062 in.) from Case for 10s | 300 | $^\circ C$ |
| T_{SOLD} | Plastic Body for 10s | 260 | $^\circ C$ |
| M_d | Mounting Torque (TO-220) | 1.13 / 10 | Nm/lb.in. |
| Weight | TO-252 | 0.35 | g |
| | TO-263 | 2.50 | g |
| | TO-220 | 3.00 | g |

| Symbol | Test Conditions ($T_J = 25^\circ C$, Unless Otherwise Specified) | Characteristic Values | | |
|--------------|---|-----------------------|------|-----------------------------|
| | | Min. | Typ. | Max. |
| BV_{DSS} | $V_{GS} = 0V$, $I_D = -250\mu A$ | -100 | | V |
| $V_{GS(th)}$ | $V_{DS} = V_{GS}$, $I_D = -250\mu A$ | -2.0 | | -4.5 V |
| I_{GSS} | $V_{GS} = \pm 15V$, $V_{DS} = 0V$ | | | ± 50 nA |
| I_{DSS} | $V_{DS} = V_{DSS}$, $V_{GS} = 0V$ $T_J = 125^\circ C$ | | | -10 μA -250 μA |
| $R_{DS(on)}$ | $V_{GS} = -10V$, $I_D = 0.5 \cdot I_{D25}$, Note 1 | | | 90 m Ω |

TO-252 (IXTY)

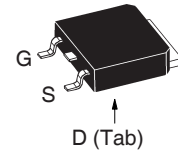

TO-263 AA (IXTA)

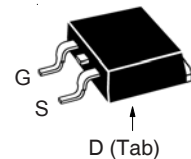

TO-220AB (IXTP)

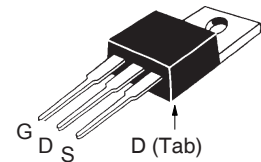
 G = Gate D = Drain
 S = Source Tab = Drain

Features

- International Standard Packages
- Avalanche Rated
- Extended FBSOA
- Fast Intrinsic Diode
- Low $R_{DS(ON)}$ and Q_G

Advantages

- Easy to Mount
- Space Savings
- High Power Density

Applications

- High-Side Switching
- Push Pull Amplifiers
- DC Choppers
- Automatic Test Equipment
- Current Regulators
- Battery Charger Applications

| Symbol | Test Conditions ($T_J = 25^\circ\text{C}$, Unless Otherwise Specified) | Characteristic Values | | |
|--------------|---|-----------------------|------|-------------------------|
| | | Min. | Typ. | Max. |
| g_{fs} | $V_{DS} = -10\text{V}$, $I_D = 0.5 \cdot I_{D25}$, Note 1 | 10 | 17 | S |
| C_{iss} | $V_{GS} = 0\text{V}$, $V_{DS} = -25\text{V}$, $f = 1\text{MHz}$ | | 3820 | pF |
| C_{oss} | | | 280 | pF |
| C_{rss} | | | 93 | pF |
| $t_{d(on)}$ | Resistive Switching Times $V_{GS} = -10\text{V}$, $V_{DS} = 0.5 \cdot V_{DSS}$, $I_D = 0.5 \cdot I_{D25}$ $R_G = 3\Omega$ (External) | | 20 | ns |
| t_r | | | 15 | ns |
| $t_{d(off)}$ | | | 37 | ns |
| t_f | | | 11 | ns |
| $Q_{g(on)}$ | $V_{GS} = -10\text{V}$, $V_{DS} = 0.5 \cdot V_{DSS}$, $I_D = 0.5 \cdot I_{D25}$ | | 52 | nC |
| Q_{gs} | | | 18 | nC |
| Q_{gd} | | | 16 | nC |
| R_{thJC} | TO-220 | | | 0.83 $^\circ\text{C/W}$ |
| R_{thCS} | | 0.50 | | $^\circ\text{C/W}$ |

Source-Drain Diode

| Symbol | Test Conditions ($T_J = 25^\circ\text{C}$, Unless Otherwise Specified) | Characteristic Values | | |
|----------|---|-----------------------|------|--------|
| | | Min. | Typ. | Max. |
| I_S | $V_{GS} = 0\text{V}$ | | | - 26 A |
| I_{SM} | Repetitive, Pulse Width Limited by T_{JM} | | | -104 A |
| V_{SD} | $I_F = I_S$, $V_{GS} = 0\text{V}$, Note 1 | | | -1.5 V |
| t_{rr} | $I_F = 0.5 \cdot I_{D25}$, $-di/dt = -100\text{A}/\mu\text{s}$ $V_R = -50\text{V}$, $V_{GS} = 0\text{V}$ | | 70 | ns |
| Q_{RM} | | | 210 | nC |
| I_{RM} | | | - 6 | A |

Note 1: Pulse test, $t \leq 300\mu\text{s}$, duty cycle, $d \leq 2\%$.

TO-263 Outline

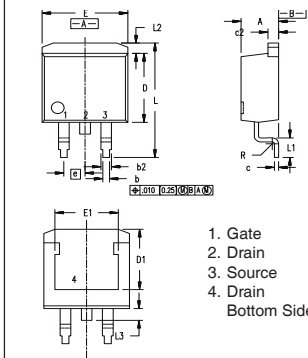

| Dim. | Millimeter | | Inches | |
|------|------------|-------|--------|------|
| | Min. | Max. | Min. | Max. |
| A | 4.06 | 4.83 | .160 | .190 |
| b | 0.51 | 0.99 | .020 | .039 |
| b2 | 1.14 | 1.40 | .045 | .055 |
| c | 0.40 | 0.74 | .016 | .029 |
| c2 | 1.14 | 1.40 | .045 | .055 |
| D | 8.64 | 9.65 | .340 | .380 |
| D1 | 8.00 | 8.89 | .280 | .320 |
| E | 9.65 | 10.41 | .380 | .405 |
| E1 | 6.22 | 8.13 | .270 | .320 |
| e | 2.54 | BSC | .100 | BSC |
| L | 14.61 | 15.88 | .575 | .625 |
| L1 | 2.29 | 2.79 | .090 | .110 |
| L2 | 1.02 | 1.40 | .040 | .055 |
| L3 | 1.27 | 1.78 | .050 | .070 |
| L4 | 0 | 0.13 | 0 | .005 |

TO-252 Outline

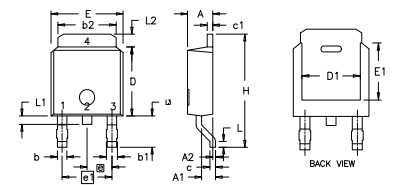

Pins: 1 - Gate 2,4 - Drain
3 - Source

| Dim. | Millimeter | | Inches | |
|------|------------|-------|-----------|-------|
| | Min. | Max. | Min. | Max. |
| A | 2.19 | 2.38 | 0.086 | 0.094 |
| A1 | 0.89 | 1.14 | 0.035 | 0.045 |
| A2 | 0 | 0.13 | 0 | 0.005 |
| b | 0.64 | 0.89 | 0.025 | 0.035 |
| b1 | 0.76 | 1.14 | 0.030 | 0.045 |
| b2 | 5.21 | 5.46 | 0.205 | 0.215 |
| c | 0.46 | 0.58 | 0.018 | 0.023 |
| c1 | 0.46 | 0.58 | 0.018 | 0.023 |
| D | 5.97 | 6.22 | 0.235 | 0.245 |
| D1 | 4.32 | 5.21 | 0.170 | 0.205 |
| E | 6.35 | 6.73 | 0.250 | 0.265 |
| E1 | 4.32 | 5.21 | 0.170 | 0.205 |
| e | 2.28 BSC | | 0.090 BSC | |
| e1 | 4.57 BSC | | 0.180 BSC | |
| H | 9.40 | 10.42 | 0.370 | 0.410 |
| L | 0.51 | 1.02 | 0.020 | 0.040 |
| L1 | 0.64 | 1.02 | 0.025 | 0.040 |
| L2 | 0.89 | 1.27 | 0.035 | 0.050 |
| L3 | 2.54 | 2.92 | 0.100 | 0.115 |

TO-220 Outline

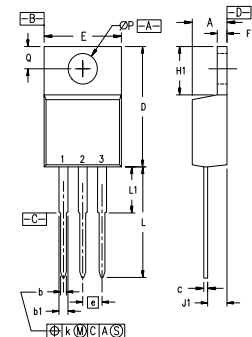

Pins: 1 - Gate 2 - Drain
3 - Source

| SYM | INCHES | | MILLIMETERS | |
|-----|----------|------|-------------|-------|
| | MIN | MAX | MIN | MAX |
| A | .170 | .190 | 4.32 | 4.83 |
| b | .025 | .040 | 0.64 | 1.02 |
| b1 | .045 | .065 | 1.15 | 1.65 |
| c | .014 | .022 | 0.35 | 0.56 |
| D | .580 | .630 | 14.73 | 16.00 |
| E | .390 | .420 | 9.91 | 10.66 |
| e | .100 BSC | | 2.54 BSC | |
| F | .045 | .055 | 1.14 | 1.40 |
| H1 | .230 | .270 | 5.85 | 6.85 |
| J1 | .090 | .110 | 2.29 | 2.79 |
| k | 0 | .015 | 0 | 0.38 |
| L | .500 | .550 | 12.70 | 13.97 |
| L1 | .110 | .230 | 2.79 | 5.84 |
| ØP | .139 | .161 | 3.53 | 4.08 |
| Q | .100 | .125 | 2.54 | 3.18 |

ADVANCE TECHNICAL INFORMATION

The product presented herein is under development. The Technical Specifications offered are derived from a subjective evaluation of the design, based upon prior knowledge and experience, and constitute a "considered reflection" of the anticipated result. IXYS reserves the right to change limits, test conditions, and dimensions without notice.

IXYS Reserves the Right to Change Limits, Test Conditions, and Dimensions.

| | | | | | | | | | | |
|--|-----------|-----------|-----------|-----------|--------------|--------------|--------------|--------------|--------------|-------------|
| IXYS MOSFETs and IGBTs are covered by one or more of the following U.S. patents: | 4,835,592 | 4,931,844 | 5,049,961 | 5,237,481 | 6,162,665 | 6,404,065 B1 | 6,683,344 | 6,727,585 | 7,005,734 B2 | 7,157,338B2 |
| | 4,850,072 | 5,017,508 | 5,063,307 | 5,381,025 | 6,259,123 B1 | 6,534,343 | 6,710,405 B2 | 6,759,692 | 7,063,975 B2 | |
| | 4,881,106 | 5,034,796 | 5,187,117 | 5,486,715 | 6,306,728 B1 | 6,583,505 | 6,710,463 | 6,771,478 B2 | 7,071,537 | |

Fig. 1. Output Characteristics @ $T_J = 25^\circ\text{C}$

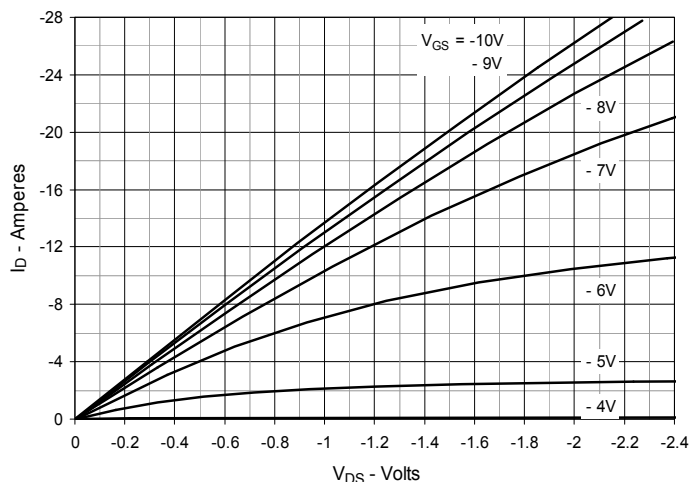

Fig. 2. Extended Output Characteristics @ $T_J = 25^\circ\text{C}$

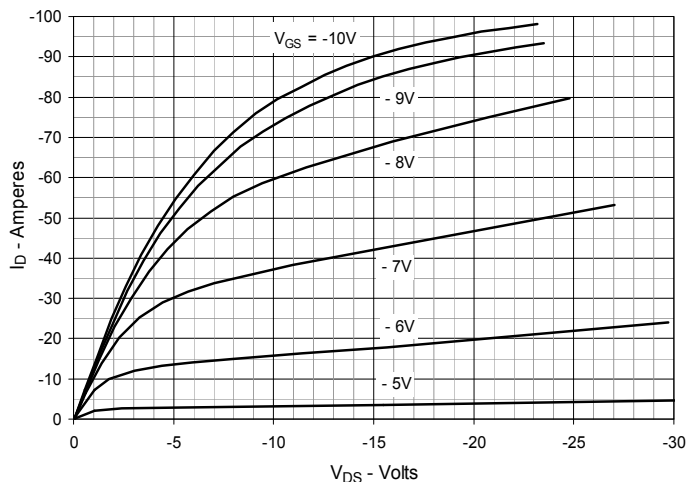

Fig. 3. Output Characteristics @ $T_J = 125^\circ\text{C}$

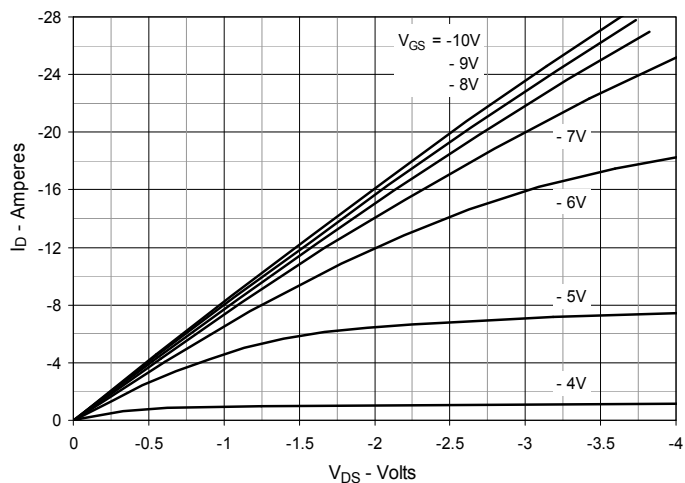

Fig. 4. $R_{DS(on)}$ Normalized to $I_D = -13\text{A}$ vs. Junction Temperature

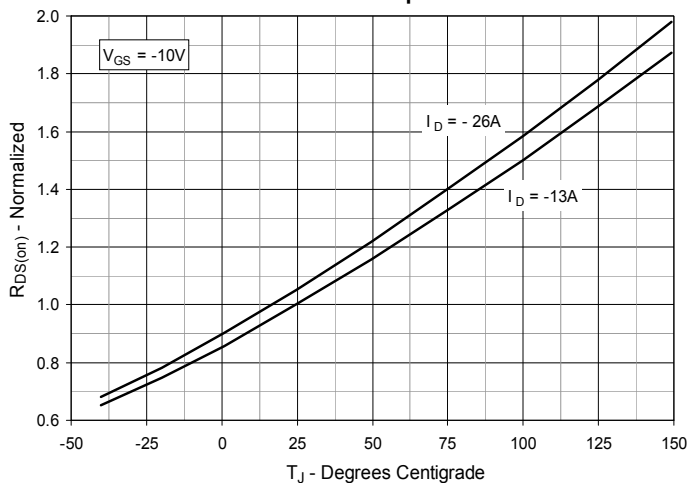

Fig. 5. $R_{DS(on)}$ Normalized to $I_D = -13\text{A}$ vs. Drain Current

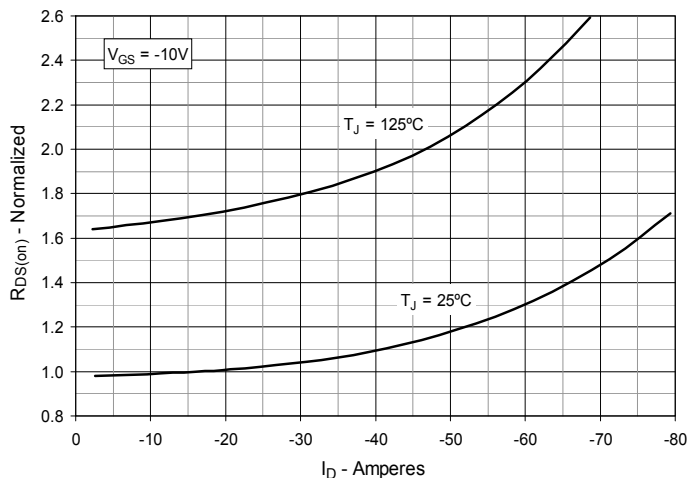

Fig. 6. Maximum Drain Current vs. Case Temperature

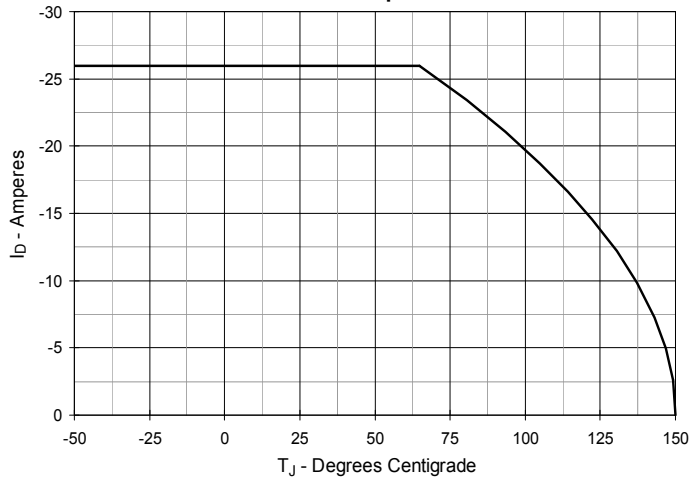

Fig. 7. Input Admittance

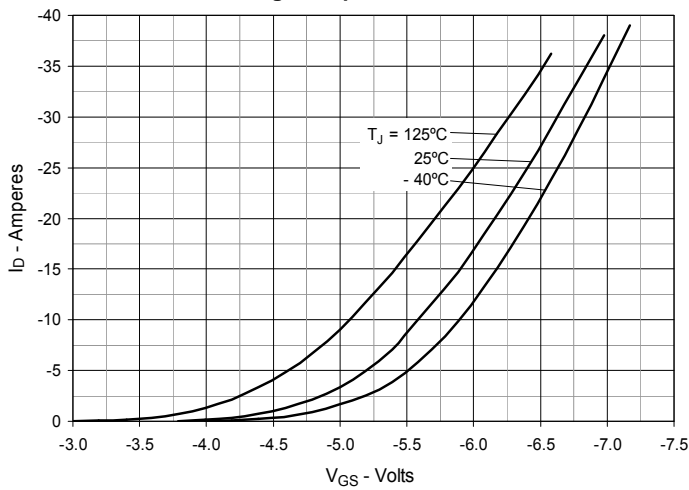

Fig. 8. Transconductance

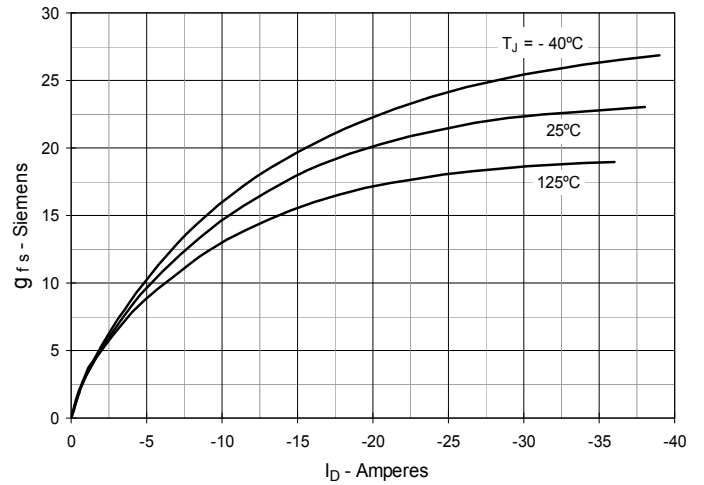

Fig. 9. Forward Voltage Drop of Intrinsic Diode

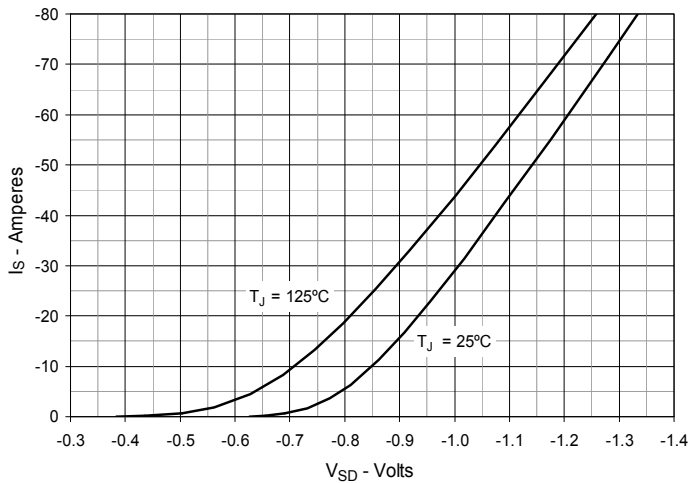

Fig. 10. Gate Charge

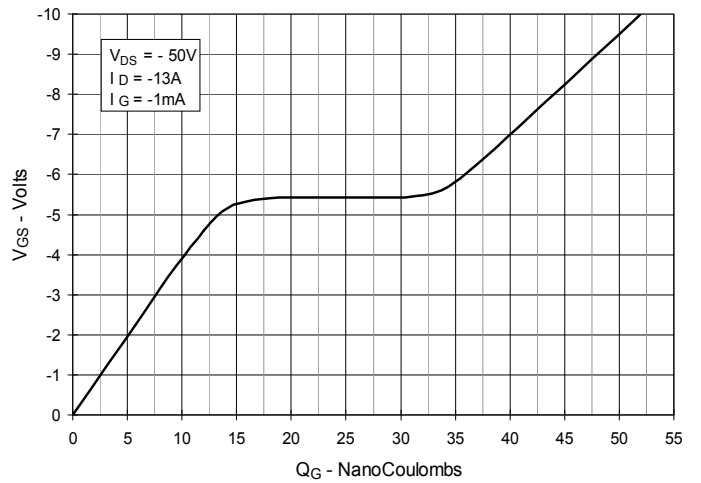

Fig. 11. Capacitance

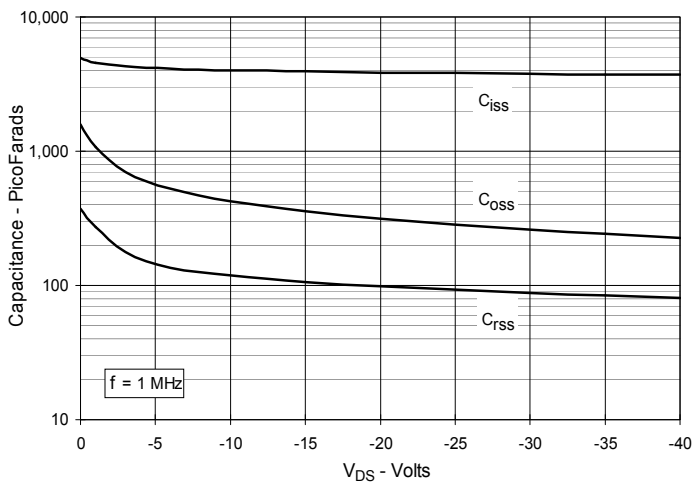

Fig. 12. Forward-Bias Safe Operating Area

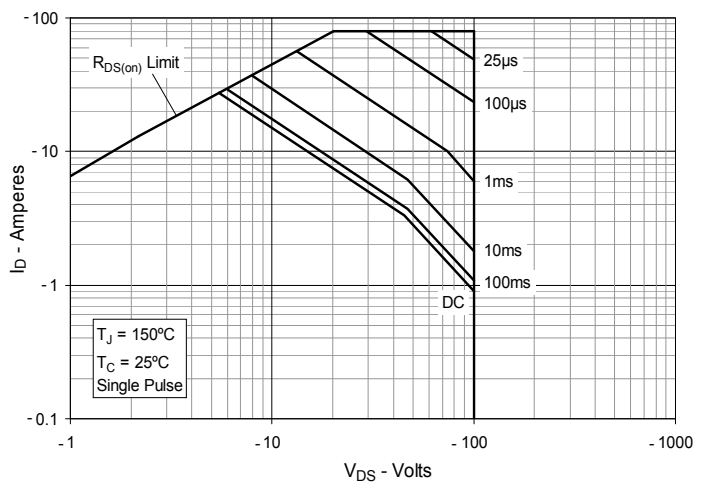

Fig. 13. Resistive Turn-on Rise Time vs. Junction Temperature

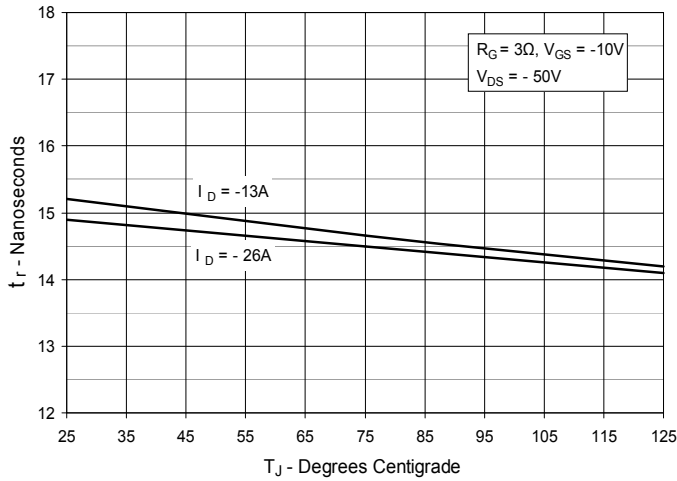

Fig. 14. Resistive Turn-on Rise Time vs. Drain Current

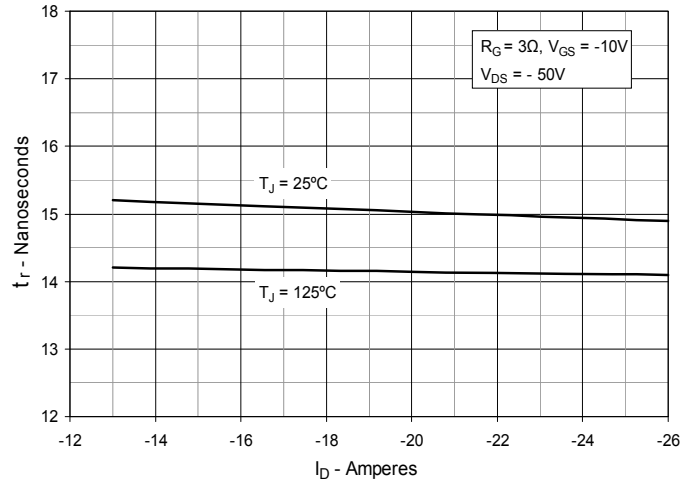

Fig. 15. Resistive Turn-on Switching Times vs. Gate Resistance

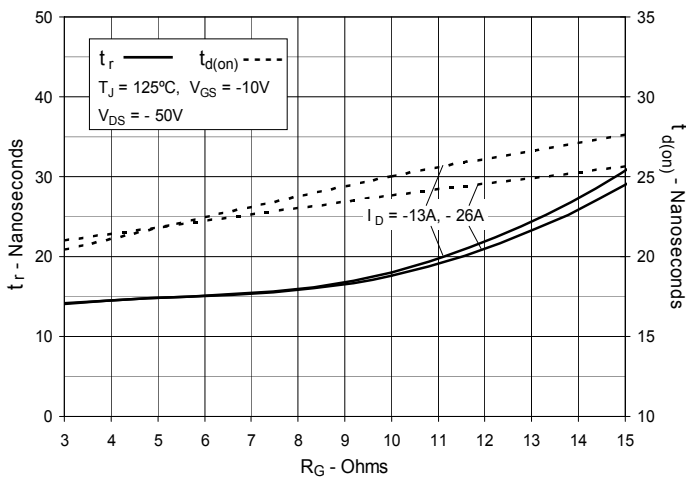

Fig. 16. Resistive Turn-off Switching Times vs. Junction Temperature

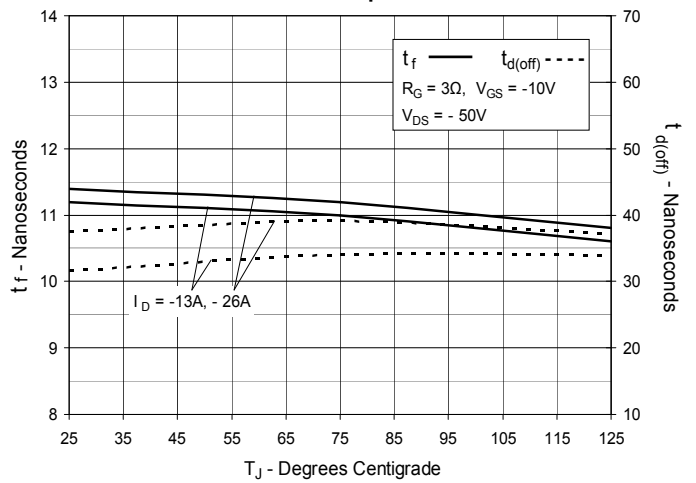

Fig. 17. Resistive Turn-off Switching Times vs. Drain Current

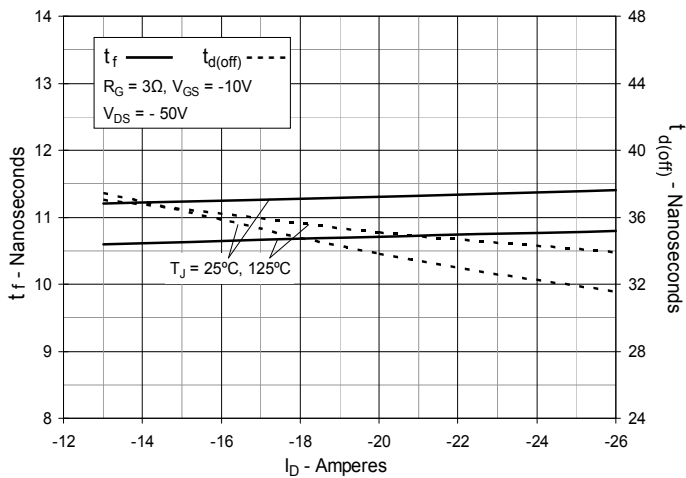

Fig. 18. Resistive Turn-off Switching Times vs. Gate Resistance

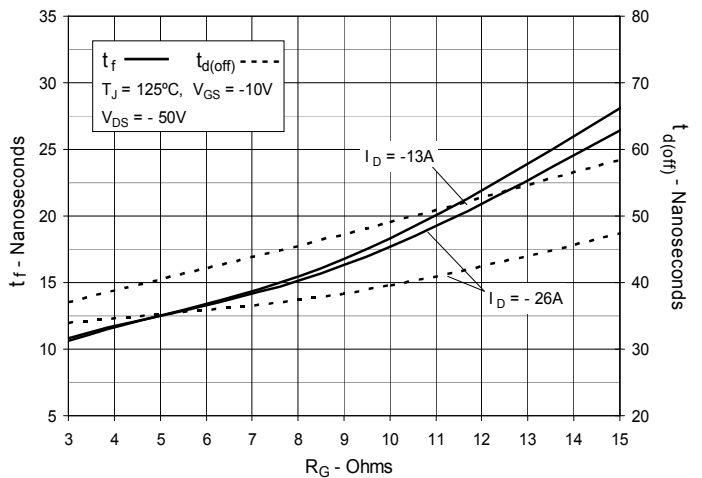

Fig. 19. Maximum Transient Thermal Impedance

