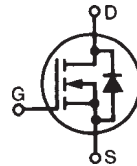
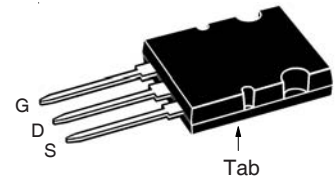

**Polar3™ HiPerFET™  
Power MOSFET**
**IXFB132N50P3**

$$\begin{aligned}
 V_{DSS} &= 500V \\
 I_{D25} &= 132A \\
 R_{DS(on)} &\leq 39m\Omega \\
 t_{rr} &\leq 250ns
 \end{aligned}$$

N-Channel Enhancement Mode  
Avalanche Rated  
Fast Intrinsic Rectifier

**PLUS264™**

G = Gate      D = Drain  
S = Source    Tab = Drain

Symbol	Test Conditions	Maximum Ratings	
$V_{DSS}$	$T_J = 25^\circ\text{C}$ to $150^\circ\text{C}$	500	V
$V_{DGR}$	$T_J = 25^\circ\text{C}$ to $150^\circ\text{C}$ , $R_{GS} = 1M\Omega$	500	V
$V_{GSS}$	Continuous	$\pm 30$	V
$V_{GSM}$	Transient	$\pm 40$	V
$I_{D25}$	$T_C = 25^\circ\text{C}$	132	A
$I_{DM}$	$T_C = 25^\circ\text{C}$ , Pulse Width Limited by $T_{JM}$	330	A
$I_A$	$T_C = 25^\circ\text{C}$	66	A
$E_{AS}$	$T_C = 25^\circ\text{C}$	3	J
$dv/dt$	$I_S \leq I_{DM}$ , $V_{DD} \leq V_{DSS}$ , $T_J \leq 150^\circ\text{C}$	35	V/ns
$P_D$	$T_C = 25^\circ\text{C}$	1890	W
$T_J$		-55 ... +150	$^\circ\text{C}$
$T_{JM}$		150	$^\circ\text{C}$
$T_{stg}$		-55 ... +150	$^\circ\text{C}$
$T_L$	1.6mm (0.062 in.) from Case for 10s	300	$^\circ\text{C}$
$T_{SOLD}$	Plastic Body for 10s	260	$^\circ\text{C}$
$F_C$	Mounting Force	30..120/6.7..27	N/lb.
<b>Weight</b>		10	g

**Features**

- Avalanche Rated
- Low Package Inductance
- Fast Intrinsic Rectifier
- Low  $R_{DS(on)}$  and  $Q_G$

**Advantages**

- Easy to Mount
- Space Savings

**Applications**

- DC-DC Converters
- Battery Chargers
- Switch-Mode and Resonant-Mode Power Supplies
- Uninterrupted Power Supplies
- AC Motor Drives
- High Speed Power Switching Applications

Symbol	Test Conditions ( $T_J = 25^\circ\text{C}$ Unless Otherwise Specified)	Characteristic Values		
		Min.	Typ.	Max.
$BV_{DSS}$	$V_{GS} = 0V$ , $I_D = 3mA$	500		V
$V_{GS(th)}$	$V_{DS} = V_{GS}$ , $I_D = 8mA$	3.0		5.0 V
$I_{GSS}$	$V_{GS} = \pm 30V$ , $V_{DS} = 0V$			$\pm 200$ nA
$I_{DSS}$	$V_{DS} = V_{DSS}$ , $V_{GS} = 0V$ $T_J = 125^\circ\text{C}$			50 $\mu\text{A}$ 6 mA
$R_{DS(on)}$	$V_{GS} = 10V$ , $I_D = 0.5 \cdot I_{DSS}$ , Note 1			39 m $\Omega$

Symbol	Test Conditions ( $T_J = 25^\circ\text{C}$ Unless Otherwise Specified)	Characteristic Values		
		Min.	Typ.	Max.
$g_{fs}$	$V_{DS} = 10\text{V}, I_D = 66\text{A}$ , Note 1	68	115	S
$C_{iss}$	$V_{GS} = 0\text{V}, V_{DS} = 25\text{V}, f = 1\text{MHz}$		18.6	nF
$C_{oss}$			1750	pF
$C_{rss}$			5.0	pF
$R_{Gi}$	Gate Input Resistance		1.0	$\Omega$
$t_{d(on)}$	<b>Resistive Switching Times</b> $V_{GS} = 10\text{V}, V_{DS} = 0.5 \cdot V_{DSS}, I_D = 0.5 \cdot I_{DSS}$ $R_G = 1\Omega$ (External)		44	ns
$t_r$			9	ns
$t_{d(off)}$			72	ns
$t_f$			8	ns
$Q_{g(on)}$	$V_{GS} = 10\text{V}, V_{DS} = 0.5 \cdot V_{DSS}, I_D = 0.5 \cdot I_{DSS}$		250	nC
$Q_{gs}$			90	nC
$Q_{gd}$			52	nC
$R_{thJC}$				0.066 $^\circ\text{C/W}$
$R_{thCS}$		0.13		$^\circ\text{C/W}$

### Source-Drain Diode

Symbol	Test Conditions ( $T_J = 25^\circ\text{C}$ Unless Otherwise Specified)	Characteristic Values		
		Min.	Typ.	Max.
$I_s$	$V_{GS} = 0\text{V}$			132 A
$I_{SM}$	Repetitive, Pulse Width Limited by $T_{JM}$			530 A
$V_{SD}$	$I_F = 100\text{A}, V_{GS} = 0\text{V}$ , Note 1			1.5 V
$t_{rr}$	$I_F = 66\text{A}, -di/dt = 100\text{A}/\mu\text{s}$ $V_R = 100\text{V}, V_{GS} = 0\text{V}$			250 ns
$Q_{RM}$			1.9	$\mu\text{C}$
$I_{RM}$			16.4	A

Note 1. Pulse test,  $t \leq 300\mu\text{s}$ , duty cycle,  $d \leq 2\%$ .

### PLUS264™ (IXFB) Outline

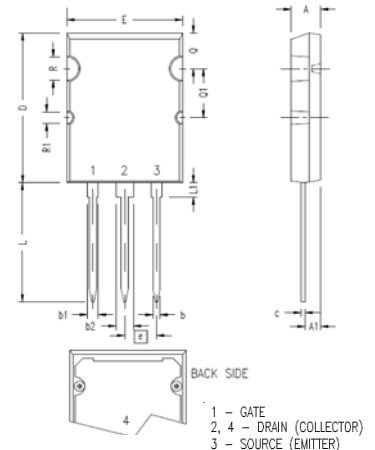

SYM	INCHES		MILLIMETERS	
	MIN	MAX	MIN	MAX
A	.185	.209	4.70	5.31
A1	.102	.118	2.59	3.00
b	.037	.055	0.94	1.40
b1	.087	.102	2.21	2.59
b2	.110	.126	2.79	3.20
c	.017	.029	0.43	0.74
D	1.007	1.047	25.58	26.59
E	.760	.799	19.30	20.29
e	.215 BSC		5.46 BSC	
L	.779	.842	19.79	21.39
L1	.087	.102	2.21	2.59
Q	.240	.256	6.10	6.50
Q1	.330	.346	8.38	8.79
ØR	.155	.187	3.94	4.75
ØR1	.085	.093	2.16	2.36

### ADVANCE TECHNICAL INFORMATION

The product presented herein is under development. The Technical Specifications offered are derived from a subjective evaluation of the design, based upon prior knowledge and experience, and constitute a "considered reflection" of the anticipated result. IXYS reserves the right to change limits, test conditions, and dimensions without notice.

IXYS Reserves the Right to Change Limits, Test Conditions, and Dimensions.

IXYS MOSFETs and IGBTs are covered by one or more of the following U.S. patents:	4,835,592	4,931,844	5,049,961	5,237,481	6,162,665	6,404,065 B1	6,683,344	6,727,585	7,005,734 B2	7,157,338B2
	4,850,072	5,017,508	5,063,307	5,381,025	6,259,123 B1	6,534,343	6,710,405 B2	6,759,692	7,063,975 B2	
	4,881,106	5,034,796	5,187,117	5,486,715	6,306,728 B1	6,583,505	6,710,463	6,771,478 B2	7,071,537	

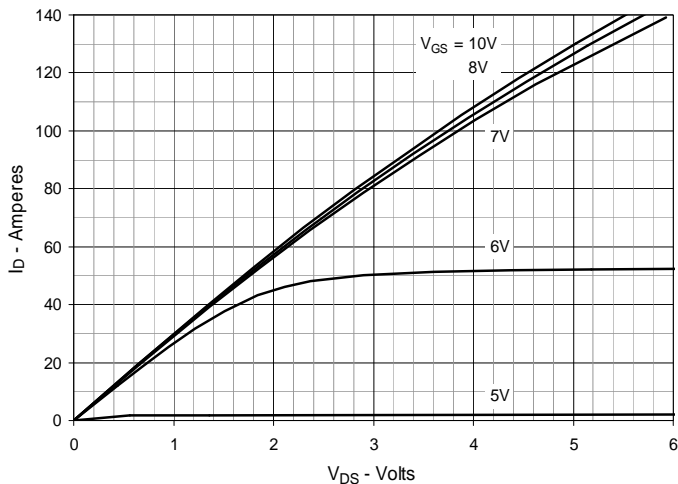
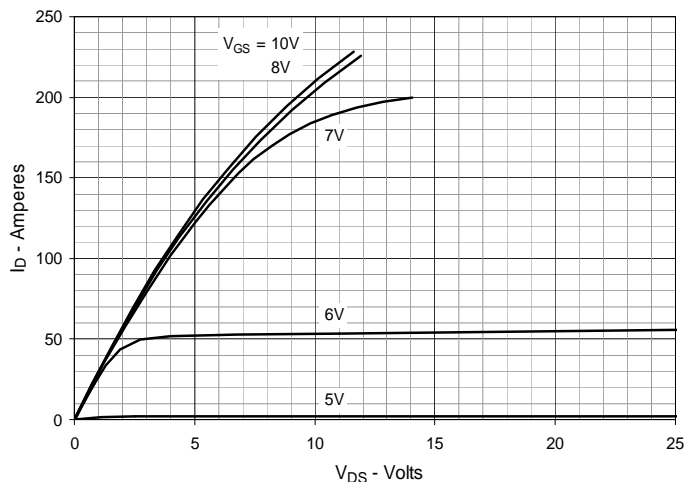
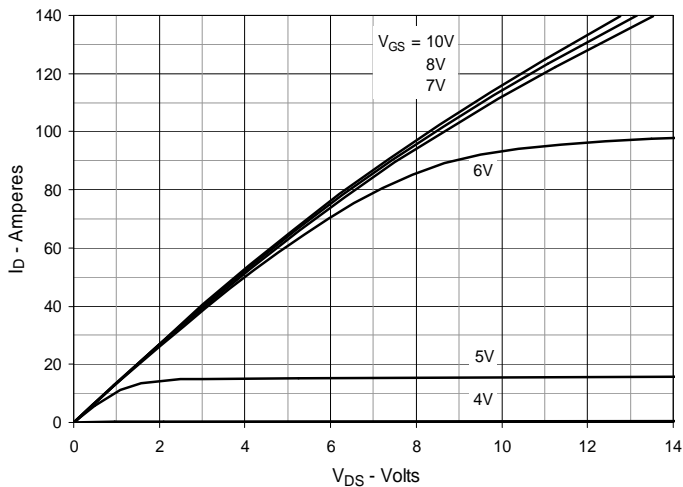
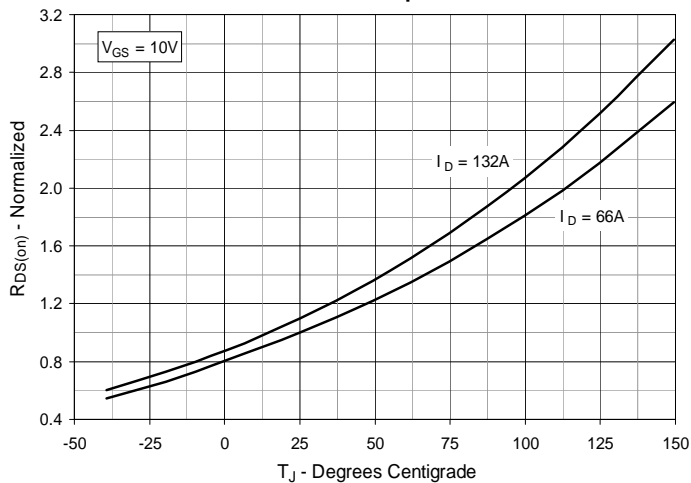
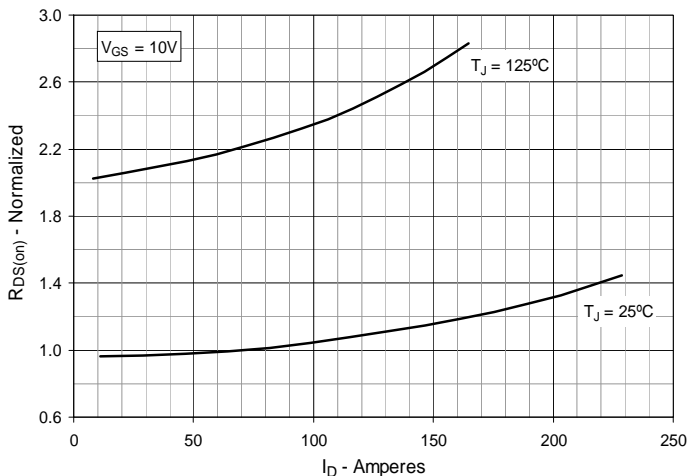
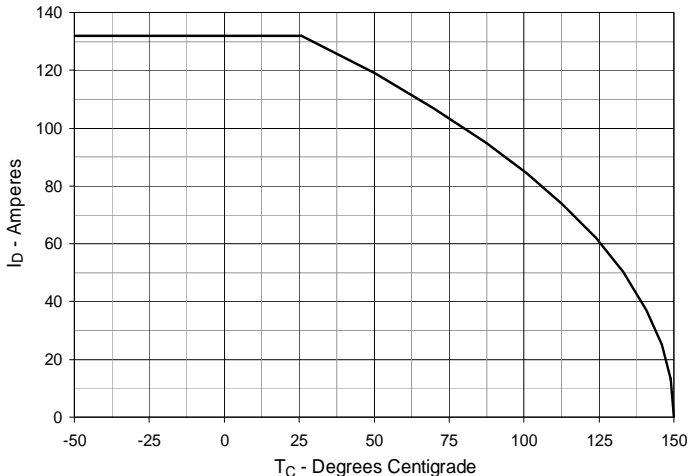
**Fig. 1. Output Characteristics @  $T_J = 25^\circ\text{C}$** 

**Fig. 2. Extended Output Characteristics @  $T_J = 25^\circ\text{C}$** 

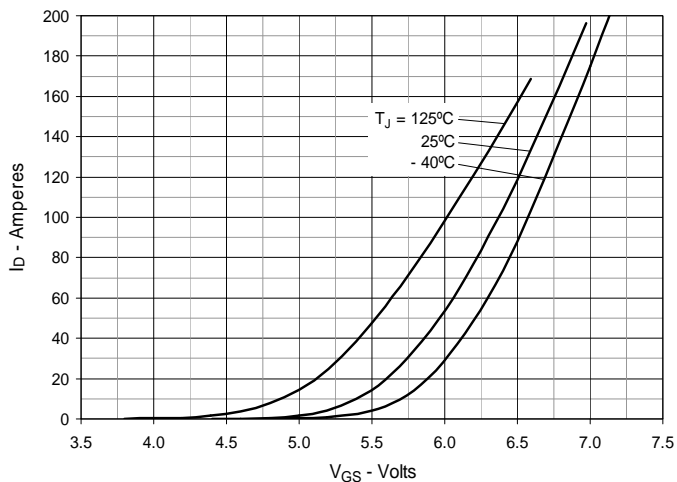
**Fig. 3. Output Characteristics @  $T_J = 125^\circ\text{C}$** 

**Fig. 4.  $R_{DS(on)}$  Normalized to  $I_D = 66\text{A}$  Value vs. Junction Temperature**

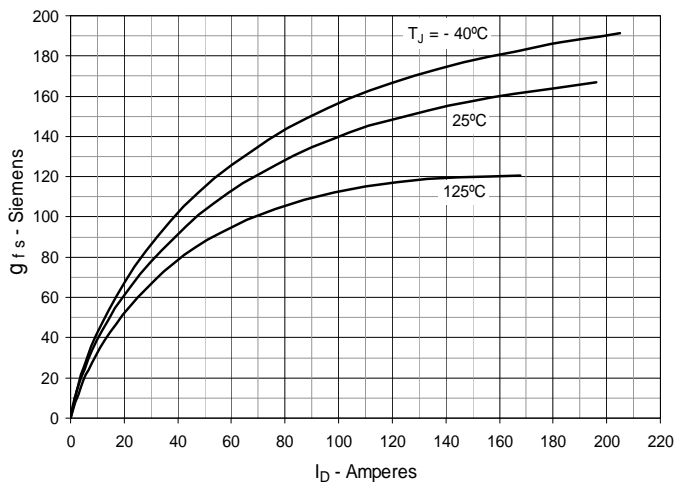
**Fig. 5.  $R_{DS(on)}$  Normalized to  $I_D = 66\text{A}$  Value vs. Drain Current**

**Fig. 6. Maximum Drain Current vs. Case Temperature**

**Fig. 7. Input Admittance**



**Fig. 8. Transconductance**



**Fig. 9. Forward Voltage Drop of Intrinsic Diode**

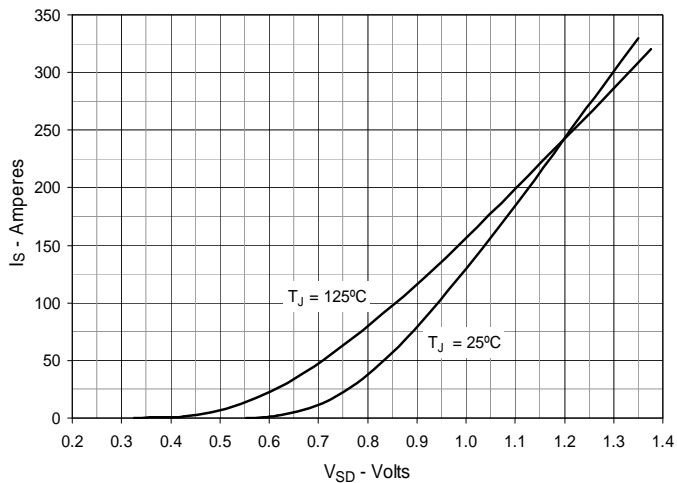

**Fig. 10. Gate Charge**

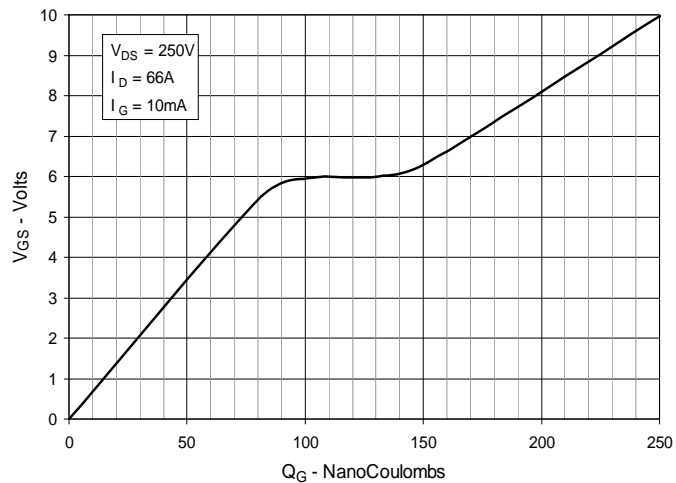

**Fig. 11. Capacitance**

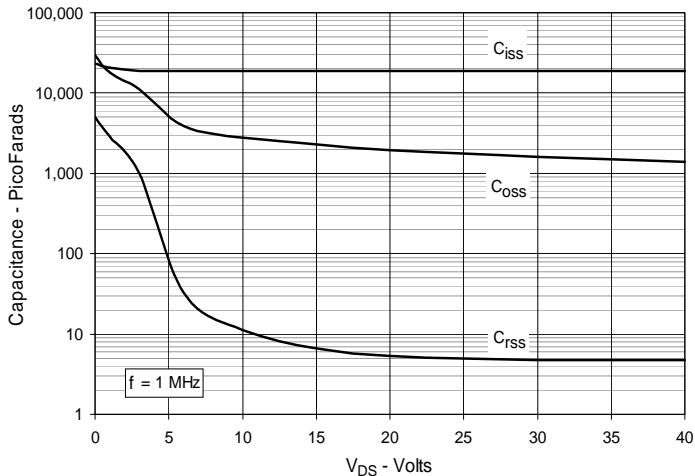

**Fig. 12. Forward-Bias Safe Operating Area**

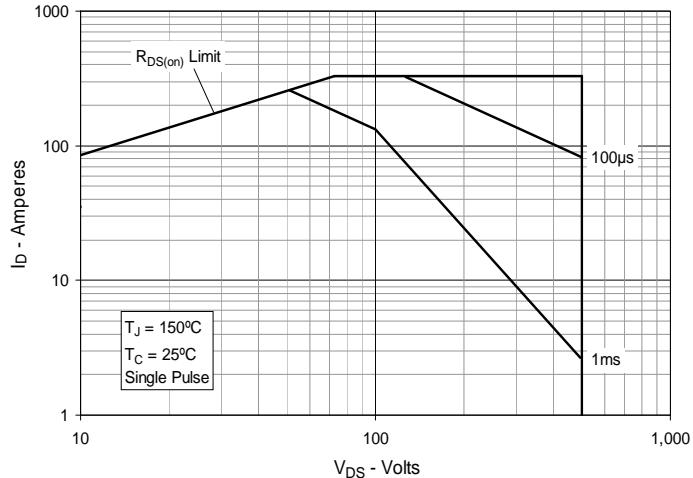

Fig. 13. Maximum Transient Thermal Impedance

