

GENERAL DESCRIPTION

This Trench MOSFET has better characteristics, such as fast switching time, low on resistance, low gate charge and excellent avalanche characteristics. It is mainly suitable for DC/DC Converter and Battery pack..

FEATURES

- $V_{DSS}=30V$, $I_D=12A$.
- Drain to Source On Resistance.
 - $R_{DS(ON)}=7m$ (Max.) @ $V_{GS}=10V$
 - $R_{DS(ON)}=11m$ (Max.) @ $V_{GS}=4.5V$

MOSFET Maximum Ratings (Ta=25 Unless otherwise noted)

CHARACTERISTIC		SYMBOL	RATING	UNIT
Drain to Source Voltage		V_{DSS}	30	V
Gate to Source Voltage		V_{GSS}	± 20	V
Drain Current	DC@Ta=25 (Note 1)	I_D	12	A
	Pulsed (Note 1)	I_{DP}	48	A
Drain Power Dissipation	@Ta=25 (Note 1)	P_D	2.5	W
Maximum Junction Temperature		T_j	150	
Storage Temperature Range		T_{stg}	-55~150	
Thermal Resistance, Junction to Ambient (Note 1)		R_{thJA}	50	/W

Note1) Surface Mounted on 1 × 1 FR4 Board, t 10sec.

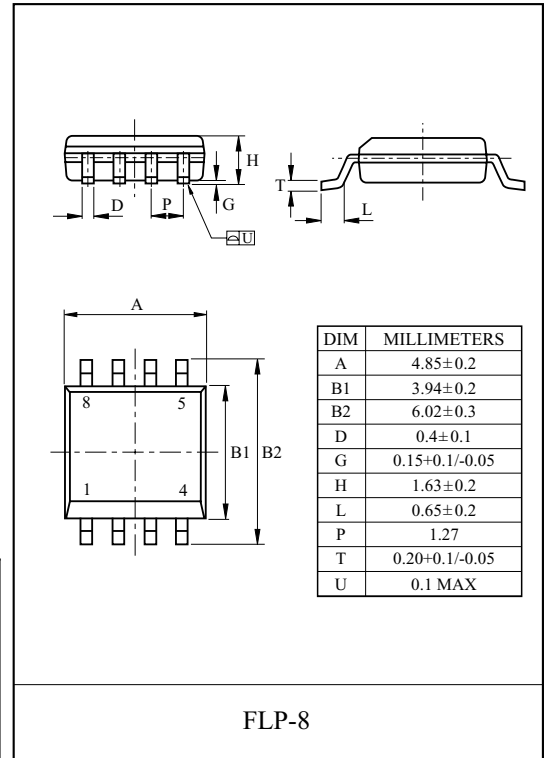

Marking

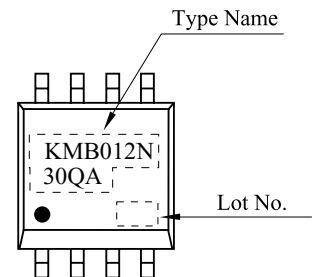

PIN CONNECTION (TOP VIEW)

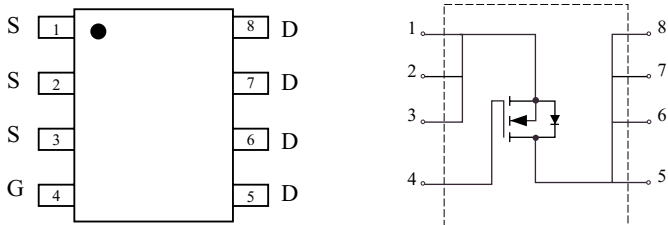

KMB012N30QA

ELECTRICAL CHARACTERISTICS (Ta=25) UNLESS OTHERWISE NOTED

CHARACTERISTIC	SYMBOL	TEST CONDITION	MIN.	TYP.	MAX.	UNIT		
Static								
Drain to Source Breakdown Voltage	BV_{DSS}	$V_{GS}=0V, I_D=250\mu A$	30	-	-	V		
Drain Cut-off Current	I_{DSS}	$V_{GS}=0V, V_{DS}=30V$	-	-	1	μA		
Gate to Source Leakage Current	I_{GSS}	$V_{GS}=\pm 20V, V_{DS}=0V$	-	-	± 100	nA		
Gate to Source Threshold Voltage	V_{th}	$V_{DS}=V_{GS}, I_D=250\mu A$	1.0	-	3.0	V		
Drain to Source On Resistance	$R_{DS(ON)}$	$V_{GS}=10V, I_D=12A$ (Note2)	-	6.0	7.0	m		
		$V_{GS}=4.5V, I_D=10A$ (Note2)	-	8.5	11.0			
Forward Transconductance	g_{fs}	$V_{DS}=5V, I_D=12A$ (Note2)	-	48	-	S		
Dynamic								
Input Capacitance	C_{iss}	$V_{DS}=15V, V_{GS}=0V, f=1MHz$ (Note2)	-	1310	-	pF		
Output Capacitance	C_{oss}		-	420	-			
Reverse Transfer Capacitance	C_{rss}		-	205	-			
Total Gate Charge	$V_{GS}=10V$	$V_{DS}=15V, V_{GS}=10V, I_D=12A$ (Note2)	-	27.0	-	nC		
	$V_{GS}=4.5V$		Q_g	-	14.5		-	
Gate to Source Charge	Q_{gs}		-	4.8	-			
Gate to Drain Charge	Q_{gd}		-	6.6	-			
Turn-On Delay Time	$t_{d(on)}$		$V_{DS}=15V, V_{GS}=10V$ $I_D=1A, R_G=6$ (Note2)	-	7.0		-	ns
Turn-On Rise Time	t_r			-	7.5		-	
Turn-Off Delay Time	$t_{d(off)}$	-		28.3	-			
Turn-Off Fall Time	t_f	-		9.9	-			
Source to Drain Diode Ratings								
Continuous Source Current	I_S	-	-	-	1.7	A		
Pulsed Source Current	I_{SP}	-	-	-	48			
Source to Drain Forward Voltage	V_{SD}	$V_{GS}=0V, I_S=1.7A$ (Note2)	-	0.75	1.2	V		
Note2) Pulse Test : Pulse Width 300 μs , Duty Cycle 2%								

KMB012N30QA

Fig1. $I_D - V_{DS}$

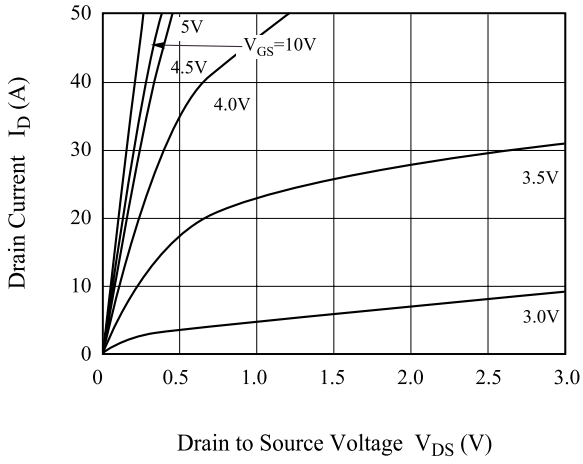

Fig2. $R_{DS(on)} - I_D$

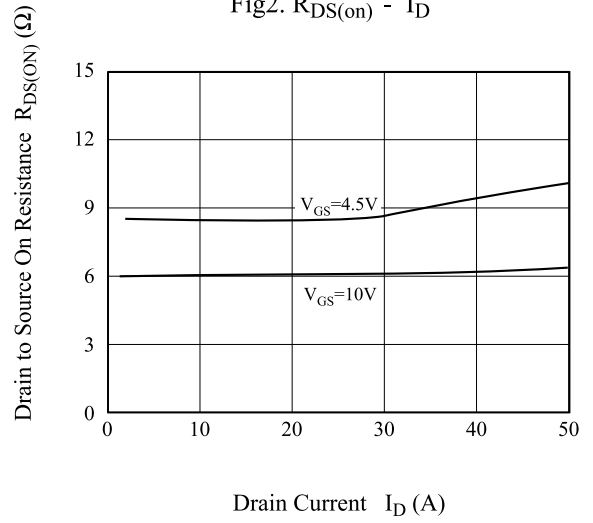

Fig3. $I_D - V_{GS}$

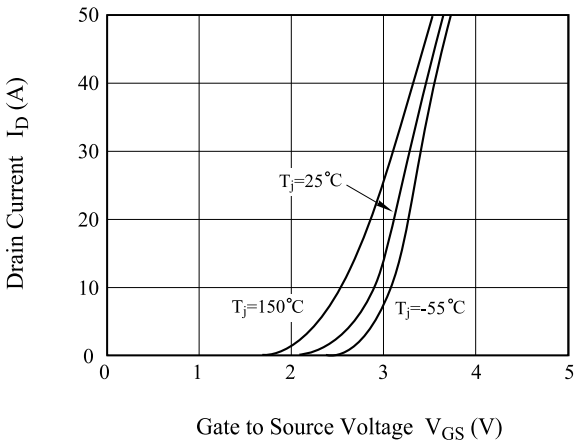

Fig4. $R_{DS(ON)} - T_j$

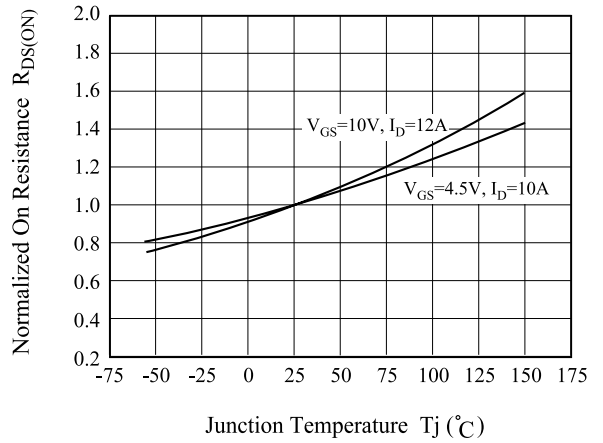

Fig5. $V_{th} - T_j$

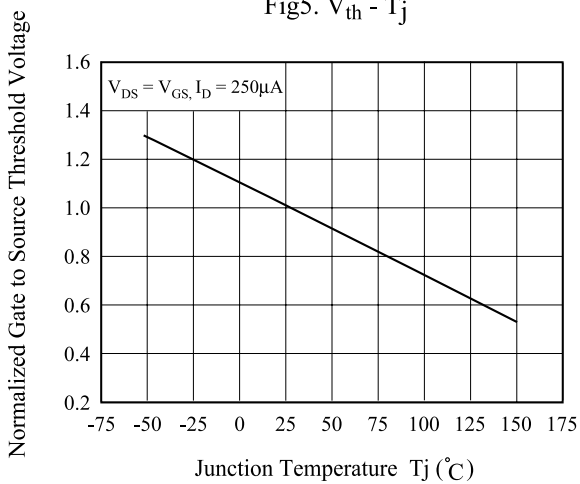
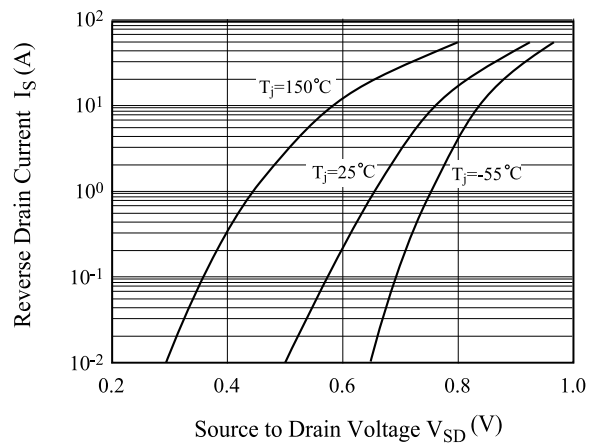

Fig6. $I_S - V_{SD}$



KMB012N30QA

