

### General Description

This planar stripe MOSFET has better characteristics, such as fast switching time, low on resistance, low gate charge and excellent avalanche characteristics. It is mainly suitable for electronic ballast and switching mode power supplies.

### FEATURES

- $V_{DSS} = 500V$ ,  $I_D = 5.0A$
- Drain-Source ON Resistance :  $R_{DS(ON)} = 1.4 \quad @V_{GS} = 10V$
- $Q_g(\text{typ}) = 12nC$

### MAXIMUM RATING (Tc=25 )

CHARACTERISTIC	SYMBOL	RATING	UNIT
Drain-Source Voltage	$V_{DSS}$	500	V
Gate-Source Voltage	$V_{GSS}$	$\pm 30$	V
Drain Current	@Tc=25	5.0	A
	@Tc=100	2.9	
	Pulsed (Note1)	13	
Single Pulsed Avalanche Energy (Note 2)	$E_{AS}$	270	mJ
Repetitive Avalanche Energy (Note 1)	$E_{AR}$	8.6	mJ
Peak Diode Recovery dv/dt (Note 3)	dv/dt	4.5	V/ns
Drain Power Dissipation	Tc=25	83	W
	Derate above 25	0.66	W/
Maximum Junction Temperature	$T_j$	150	
Storage Temperature Range	$T_{stg}$	-55 150	
<b>Thermal Characteristics</b>			
Thermal Resistance, Junction-to-Case	$R_{thJC}$	1.5	/W
Thermal Resistance, Junction-to-Ambient	$R_{thJA}$	62.5	/W

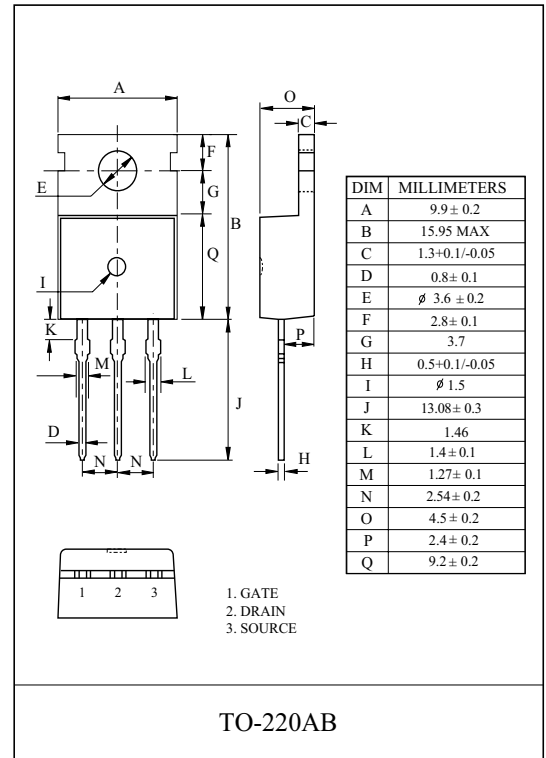

### PIN CONNECTION

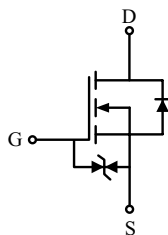

# KF5N50PZ

## ELECTRICAL CHARACTERISTICS (Tc=25 )

CHARACTERISTIC	SYMBOL	TEST CONDITION	MIN.	TYP.	MAX.	UNIT
<b>Static</b>						
Drain-Source Breakdown Voltage	$BV_{DSS}$	$I_D=250\mu A, V_{GS}=0V$	500	-	-	V
Breakdown Voltage Temperature Coefficient	$BV_{DSS}/T_j$	$I_D=250\mu A$ , Referenced to 25	-	0.55	-	V/
Drain Cut-off Current	$I_{DSS}$	$V_{DS}=500V, V_{GS}=0V$ ,	-	-	10	$\mu A$
Gate Threshold Voltage	$V_{th}$	$V_{DS}=V_{GS}, I_D=250\mu A$	2.5	-	4.5	V
Gate Leakage Current	$I_{GSS}$	$V_{GS}=\pm 25V, V_{DS}=0V$	-	-	$\pm 10$	$\mu A$
Drain-Source ON Resistance	$R_{DS(ON)}$	$V_{GS}=10V, I_D=2.5A$	-	1.15	1.4	
<b>Dynamic</b>						
Total Gate Charge	$Q_g$	$V_{DS}=400V, I_D=5A$ $V_{GS}=10V$ (Note4,5)	-	12	-	nC
Gate-Source Charge	$Q_{gs}$		-	2.4	-	
Gate-Drain Charge	$Q_{gd}$		-	5.4	-	
Turn-on Delay time	$t_{d(on)}$	$V_{DD}=250V$ $R_L=50$ $R_G=25$ (Note4,5)	-	22.5	-	ns
Turn-on Rise time	$t_r$		-	29	-	
Turn-off Delay time	$t_{d(off)}$		-	58	-	
Turn-off Fall time	$t_f$		-	18	-	
Input Capacitance	$C_{iss}$	$V_{DS}=25V, V_{GS}=0V, f=1.0MHz$	-	430	-	pF
Output Capacitance	$C_{oss}$		-	71	-	
Reverse Transfer Capacitance	$C_{rss}$		-	7.5	-	
<b>Source-Drain Diode Ratings</b>						
Continuous Source Current	$I_S$	$V_{GS}<V_{th}$	-	-	5	A
Pulsed Source Current	$I_{SP}$		-	-	20	
Diode Forward Voltage	$V_{SD}$	$I_S=5A, V_{GS}=0V$	-	-	1.4	V
Reverse Recovery Time	$t_{rr}$	$I_S=5A, V_{GS}=0V$ , $dI_S/dt=100A/\mu s$	-	300	-	ns
Reverse Recovery Charge	$Q_{rr}$		-	4.8	-	$\mu C$

Note 1) Repetivity rating : Pulse width limited by junction temperature.

Note 2)  $L=19.5mH, I_S=5A, V_{DD}=50V, R_G=25$  , Starting  $T_j=25$  .

Note 3)  $I_S=5A, dI/dt=100A/\mu s, V_{DD}=BV_{DSS}$ , Starting  $T_j=25$  .

Note 4) Pulse Test : Pulse width  $300\mu s$ , Duty Cycle  $2\%$ .

Note 5) Essentially independent of operating temperature.

## Marking

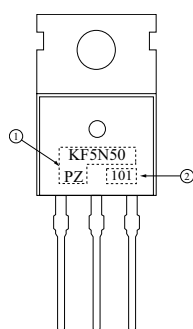

① PRODUCT NAME

② LOT NO

# KF5N50PZ

Fig1.  $I_D - V_{DS}$

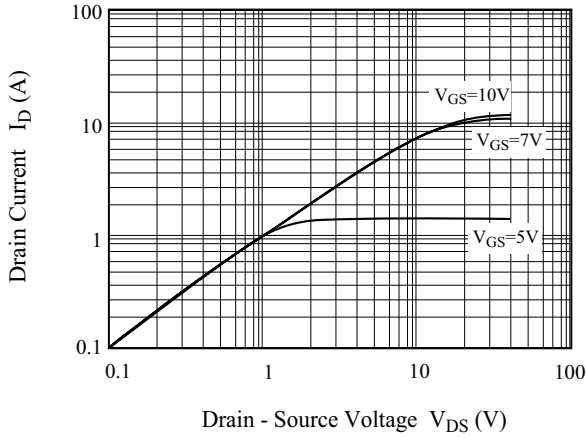

Fig2.  $I_D - V_{GS}$

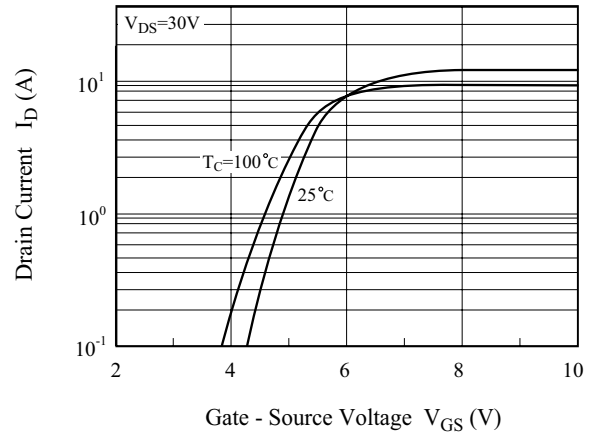

Fig3.  $BV_{DSS} - T_j$

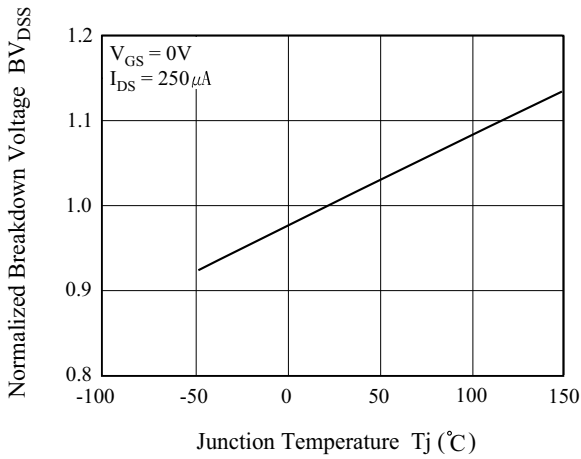

Fig4.  $R_{DS(ON)} - I_D$

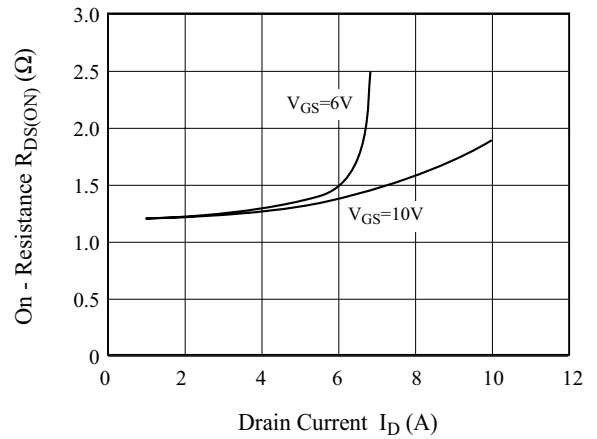

Fig5.  $I_S - V_{SD}$

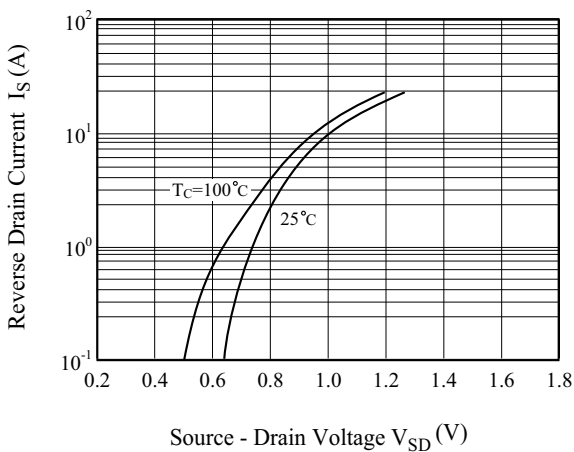
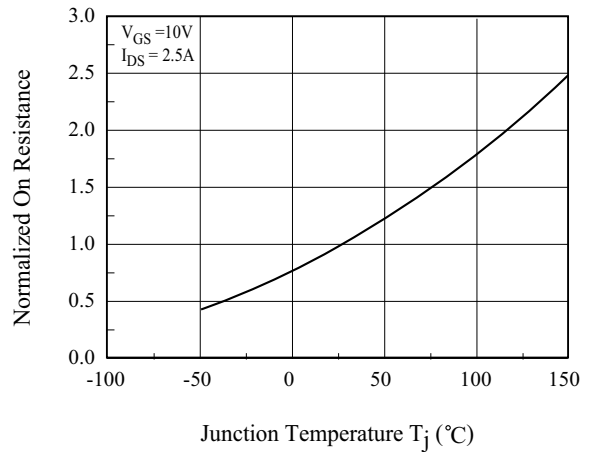

Fig6.  $R_{DS(ON)} - T_j$



# KF5N50PZ

Fig 7. C - V<sub>DS</sub>

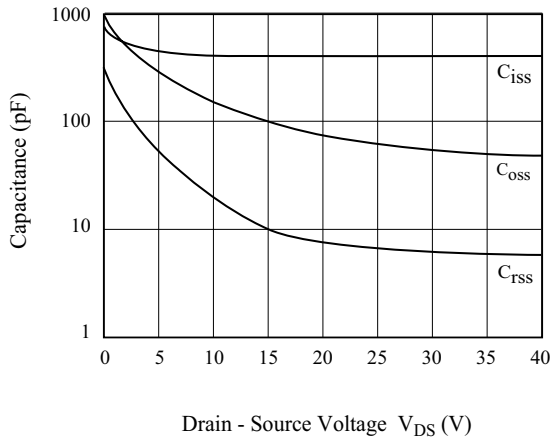

Fig8. Q<sub>g</sub>- V<sub>GS</sub>

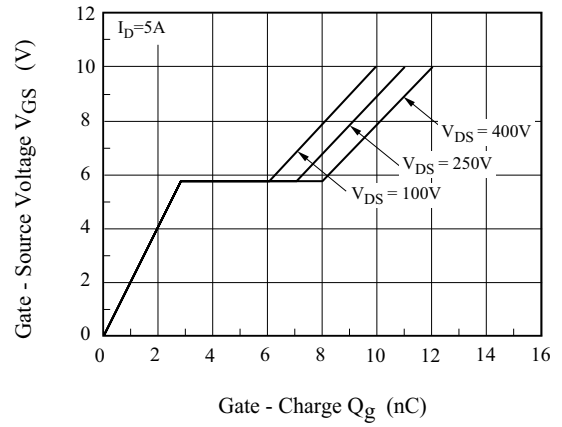

Fig9. Safe Operation Area

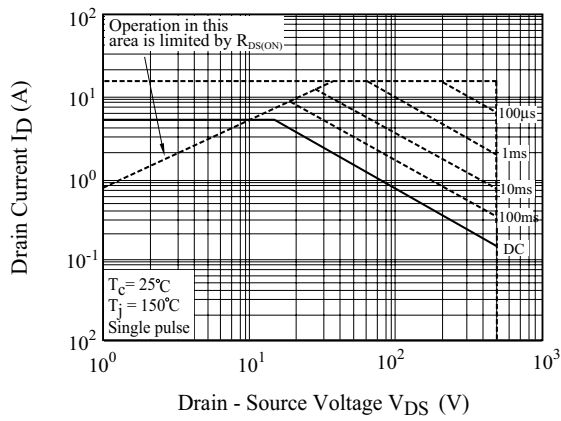

Fig10. I<sub>D</sub> - T<sub>j</sub>

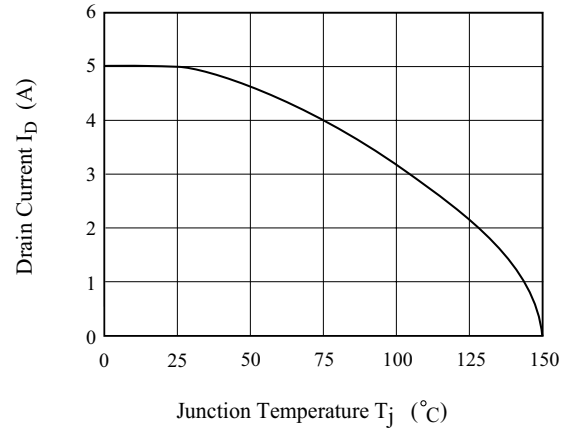
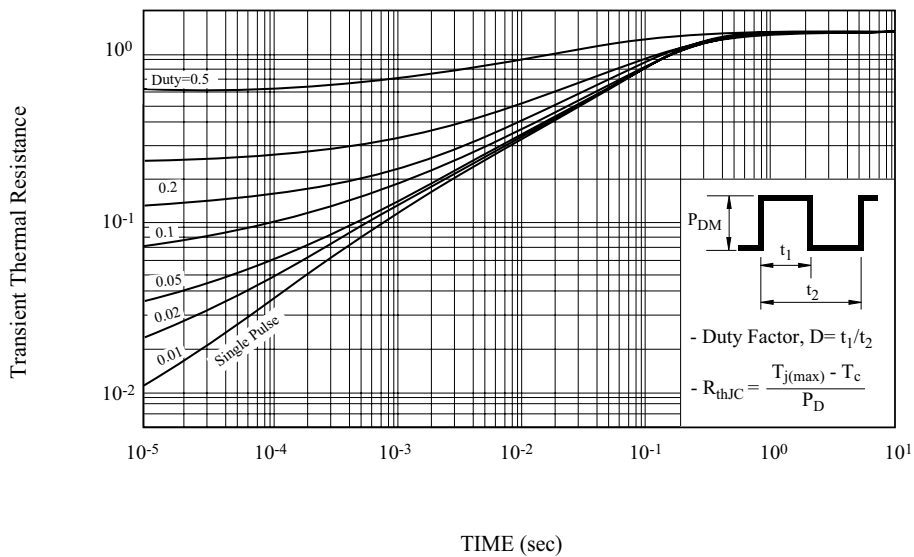

Fig11. Transient Thermal Response Curve



# KF5N50PZ

Fig12. Gate Charge

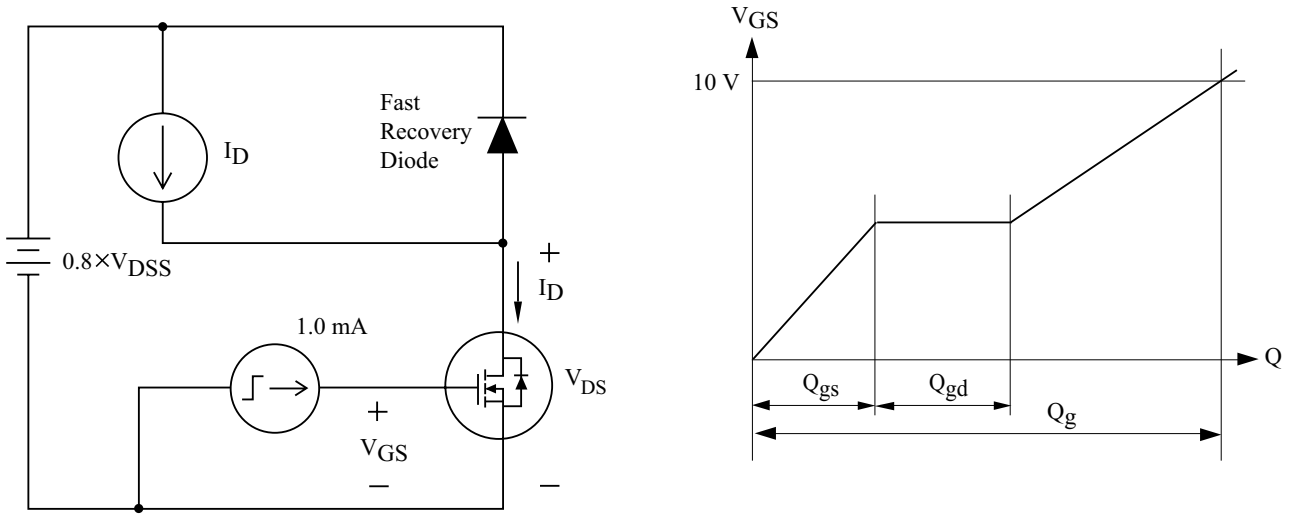

Fig13. Single Pulsed Avalanche Energy

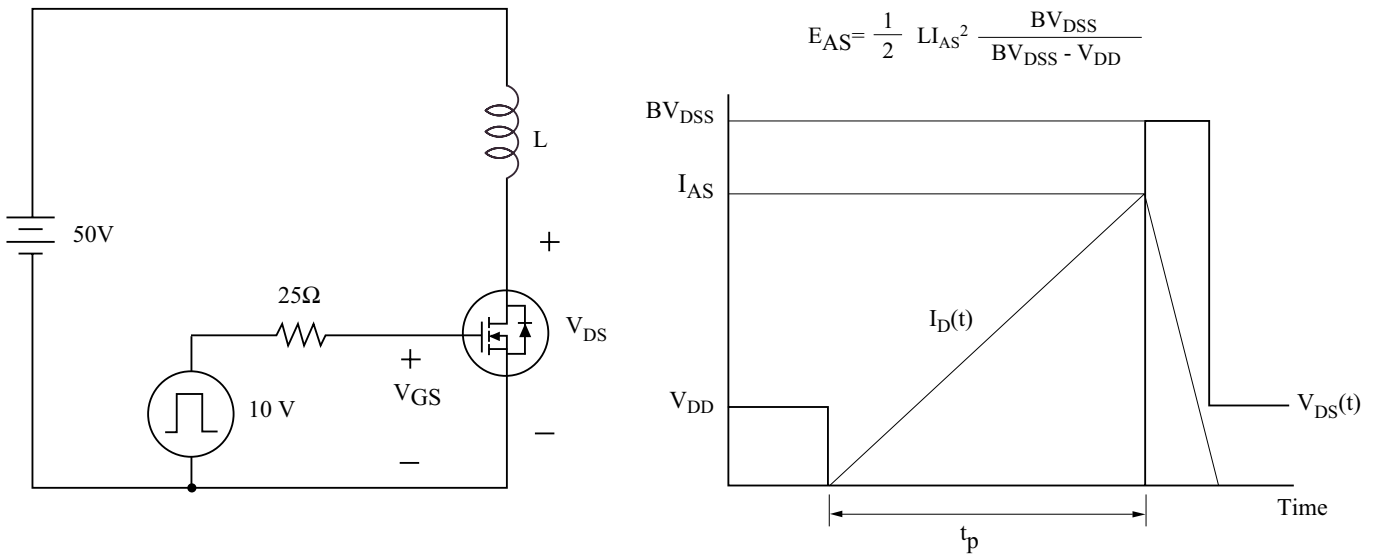
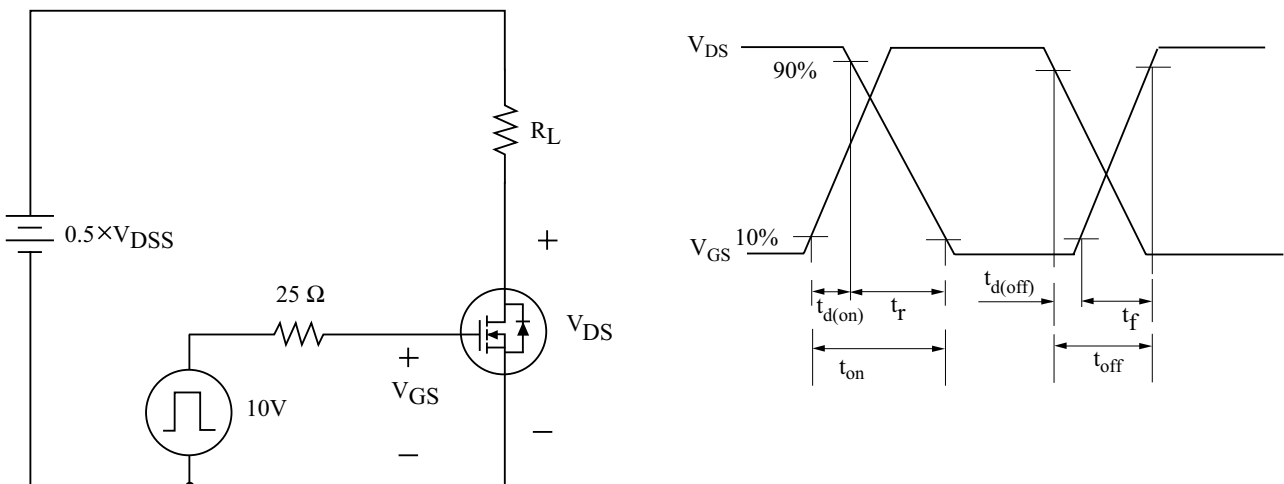

Fig14. Resistive Load Switching



# KF5N50PZ

Fig15. Source - Drain Diode Reverse Recovery and  $dv/dt$

