

General Description

This planar stripe MOSFET has better characteristics, such as fast switching time, low on resistance, low gate charge and excellent avalanche characteristics. It is mainly suitable for LED Lighting and switching mode power supplies.

FEATURES

- $V_{DSS(Min.)} = 200V$, $I_D = 1A$
- Drain-Source ON Resistance : $R_{DS(ON)} = 1.05$ (max) @ $V_{GS} = 10V$
- $Q_g(typ.) = 2.9nC$
- $V_{th(Max.)} = 2V$

MAXIMUM RATING (Tc=25 °C)

CHARACTERISTIC		SYMBOL	RATING	UNIT
Drain-Source Voltage		V_{DSS}	200	V
Gate-Source Voltage		V_{GSS}	± 20	V
Drain Current	@T _C =25	I_D	1*	A
	@T _C =100		0.6*	
	Pulsed (Note1)	I_{DP}	4*	
Single Pulsed Avalanche Energy (Note 2)		E_{AS}	52	mJ
Repetitive Avalanche Energy (Note 1)		E_{AR}	0.2	mJ
Peak Diode Recovery dv/dt (Note 3)		dv/dt	5.5	V/ns
Drain Power Dissipation	T _A =25	P_D	2.2*	W
	Derate above 25		0.018	W/°C
Maximum Junction Temperature		T _j	150	
Storage Temperature Range		T _{stg}	-55 ~ 150	
Thermal Characteristics				
Thermal Resistance, Junction-to-Ambient		R _{thJA}	57*	/W

* : Surface Mounted on FR4 Board (40mm × 40mm, 1.0t)

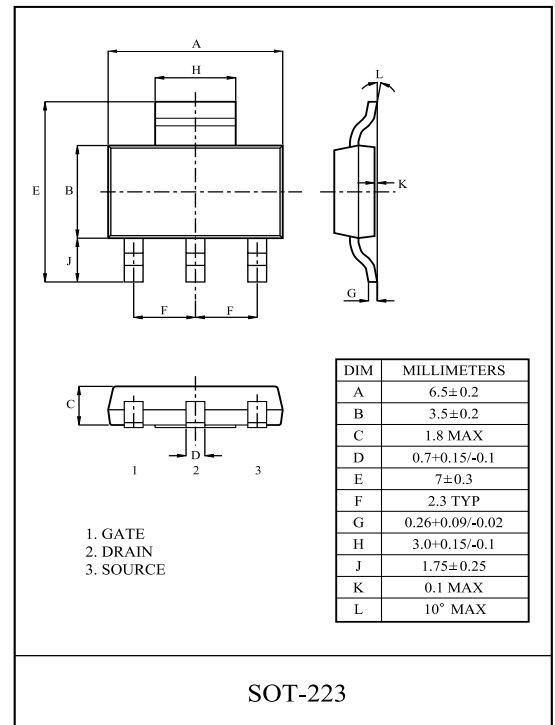

PIN CONNECTION

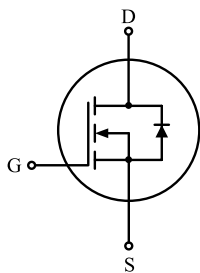

KF4N20LW

ELECTRICAL CHARACTERISTICS (Tc=25)

CHARACTERISTIC	SYMBOL	TEST CONDITION	MIN.	TYP.	MAX.	UNIT
Static						
Drain-Source Breakdown Voltage	BV_{DSS}	$I_D=250\ \mu A, V_{GS}=0V$	200	-	-	V
Breakdown Voltage Temperature Coefficient	BV_{DSS}/T_j	$I_D=250\ \mu A$, Referenced to 25	-	0.2	-	V/
Drain Cut-off Current	I_{DSS}	$V_{DS}=200V, V_{GS}=0V$,	-	-	10	μA
Gate Threshold Voltage	V_{th}	$V_{DS}=V_{GS}, I_D=250\ \mu A$	1.0	-	2.0	V
Gate Leakage Current	I_{GSS}	$V_{GS}=\pm 20V, V_{DS}=0V$	-	-	± 100	nA
Drain-Source ON Resistance	$R_{DS(ON)}$	$V_{GS}=10V, I_D=0.5A$	-	0.85	1.05	
		$V_{GS}=5V, I_D=0.5A$		0.89	1.10	
Dynamic						
Total Gate Charge	Q_g	$V_{DS}=150V, I_D=3.6A$ $V_{GS}=5V$ (Note4,5)	-	2.9	3.8	nC
Gate-Source Charge	Q_{gs}		-	0.6	-	
Gate-Drain Charge	Q_{gd}		-	2.2	-	
Turn-on Delay time	$t_{d(on)}$	$V_{DD}=100V, I_D=3.6A$ $R_G=25$ (Note4,5) $V_{GS}=5V$	-	10	-	ns
Turn-on Rise time	t_r		-	20	-	
Turn-off Delay time	$t_{d(off)}$		-	15	-	
Turn-off Fall time	t_f		-	15	-	
Input Capacitance	C_{iss}	$V_{DS}=25V, V_{GS}=0V, f=1.0MHz$	-	170	220	pF
Output Capacitance	C_{oss}		-	25	-	
Reverse Transfer Capacitance	C_{rss}		-	4.0	-	
Source-Drain Diode Ratings						
Continuous Source Current	I_S	$V_{GS}<V_{th}$	-	-	1	A
Pulsed Source Current	I_{SP}		-	-	4	
Diode Forward Voltage	V_{SD}	$I_S=1A, V_{GS}=0V$	-	-	1.4	V
Reverse Recovery Time	t_{rr}	$I_S=3.6A, V_{GS}=0V$, $dI_S/dt=100A/\mu s$	-	100	-	ns
Reverse Recovery Charge	Q_{rr}		-	0.30	-	μC

Note 1) Repetivity rating : Pulse width limited by junction temperature.

Note 2) $L = 78mH, I_S=1A, V_{DD}=50V, R_G = 25$, Starting $T_j = 25$.

Note 3) $I_S = 2A, dI/dt = 300A/\mu s, V_{DD} = BV_{DSS}$, Starting $T_j = 25$.

Note 4) Pulse Test : Pulse width $300\mu s$, Duty Cycle 2% .

Note 5) Essentially independent of operating temperature.

Marking

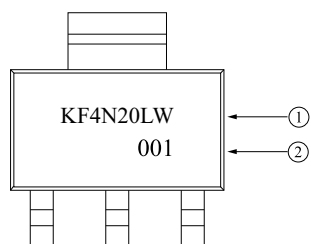

① PRODUCT NAME

② LOT NO

KF4N20LW

Fig1. $I_D - V_{DS}$

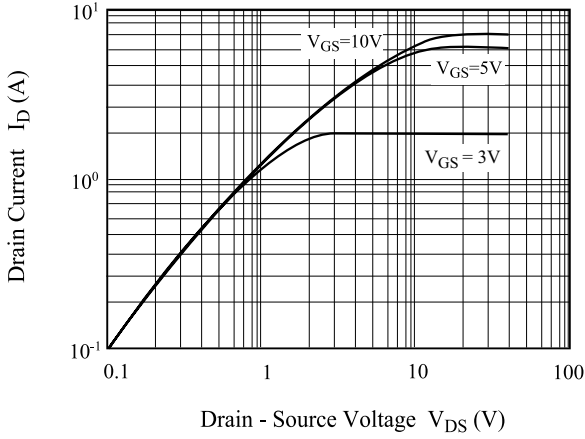

Fig2. $I_D - V_{GS}$

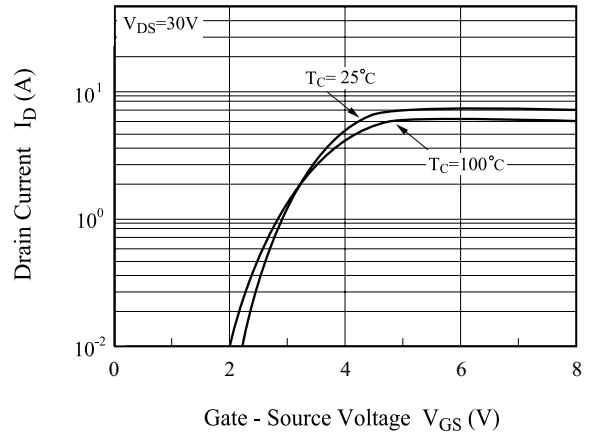

Fig3. $BV_{DSS} - T_j$

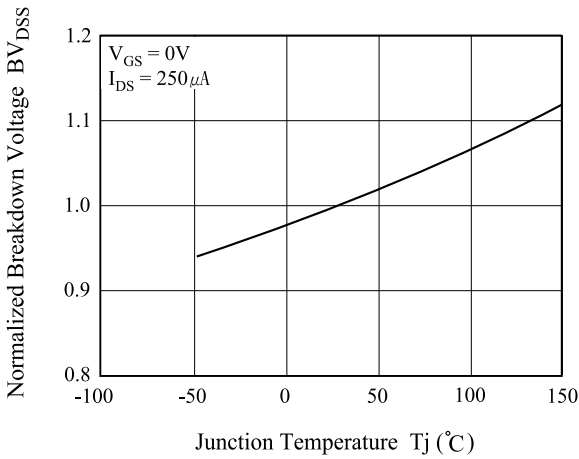

Fig4. $R_{DS(ON)} - I_D$

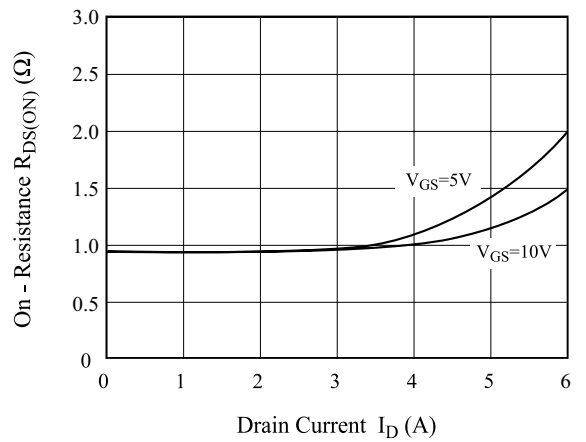

Fig5. $I_S - V_{SD}$

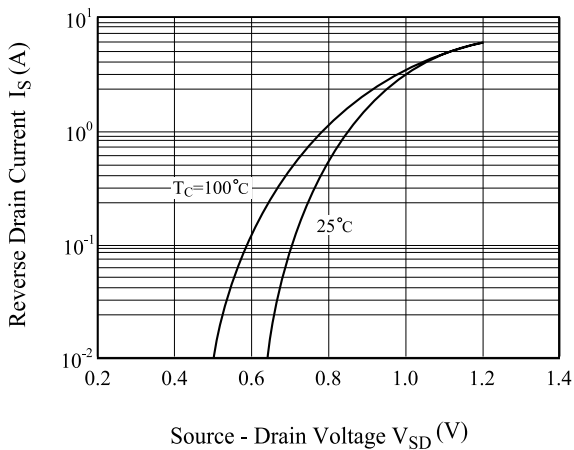
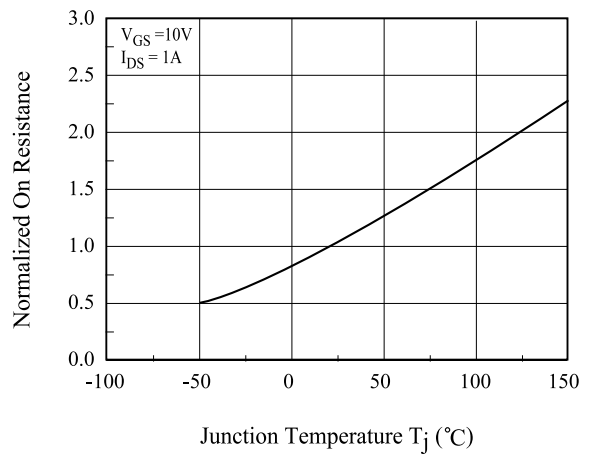

Fig6. $R_{DS(ON)} - T_j$



KF4N20LW

Fig 7. C - V_{DS}

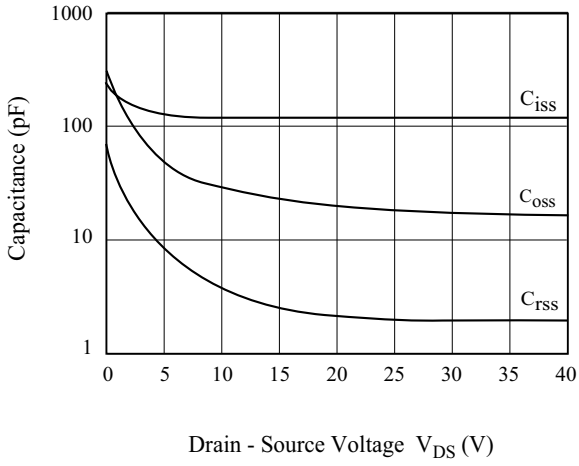

Fig8. Q_g- V_{GS}

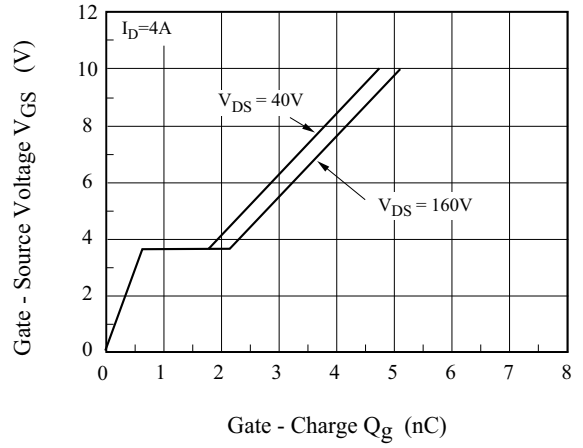

Fig9. Safe Operation Area

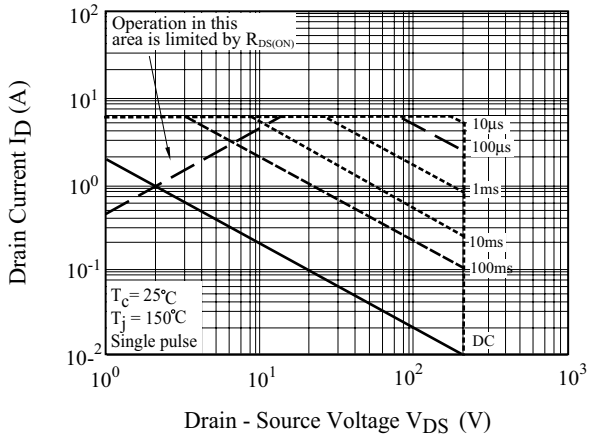

Fig10. I_D - T_j

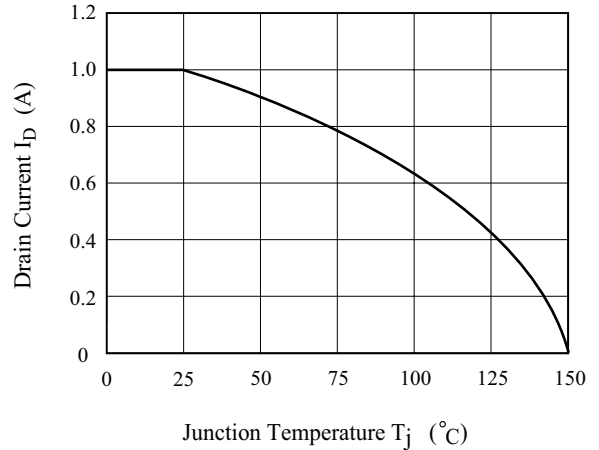

Fig11. Transient Thermal Response Curve

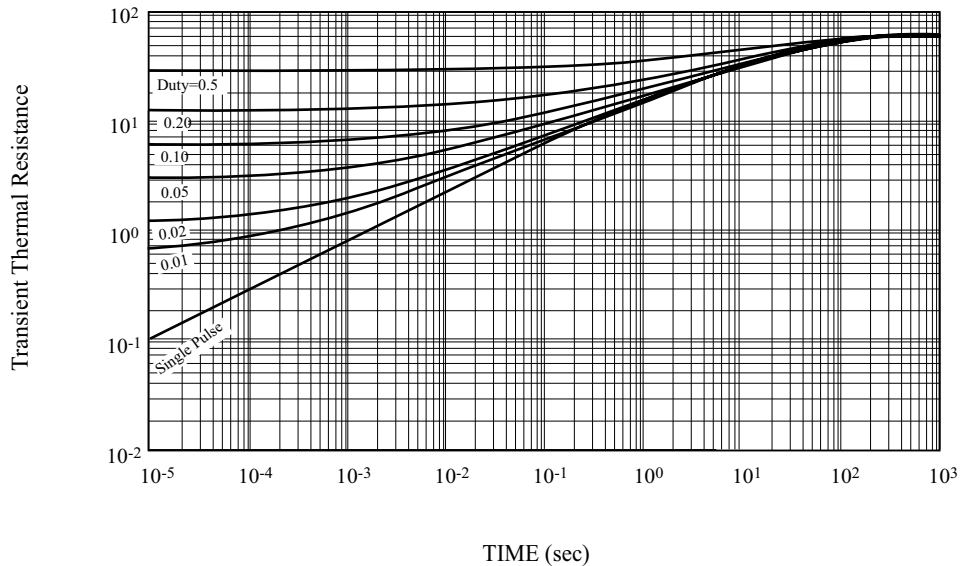

Fig12. Gate Charge

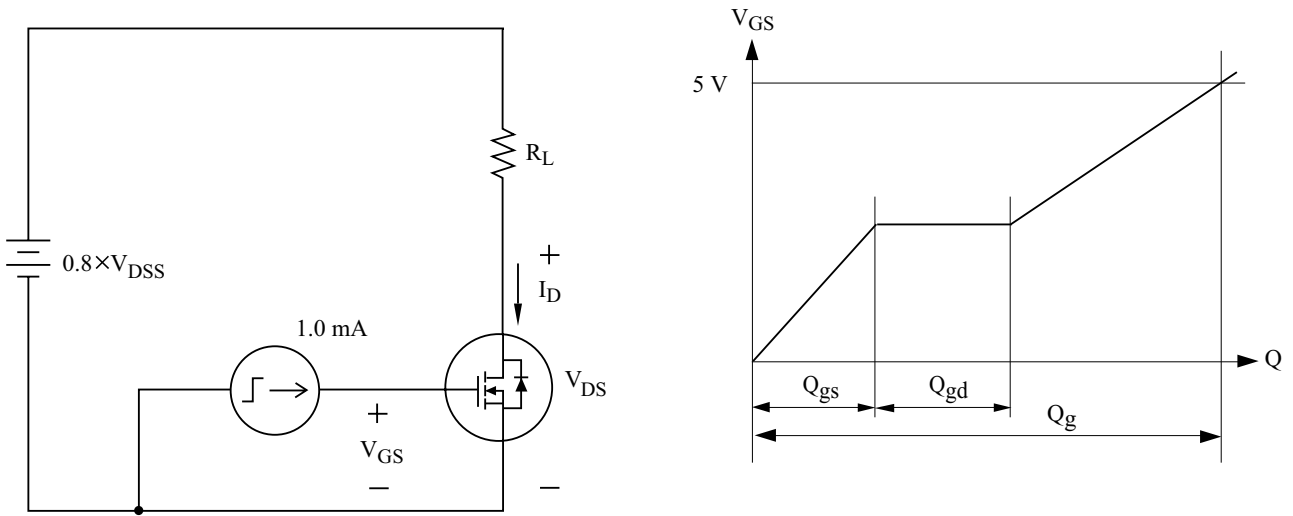

Fig13. Single Pulsed Avalanche Energy

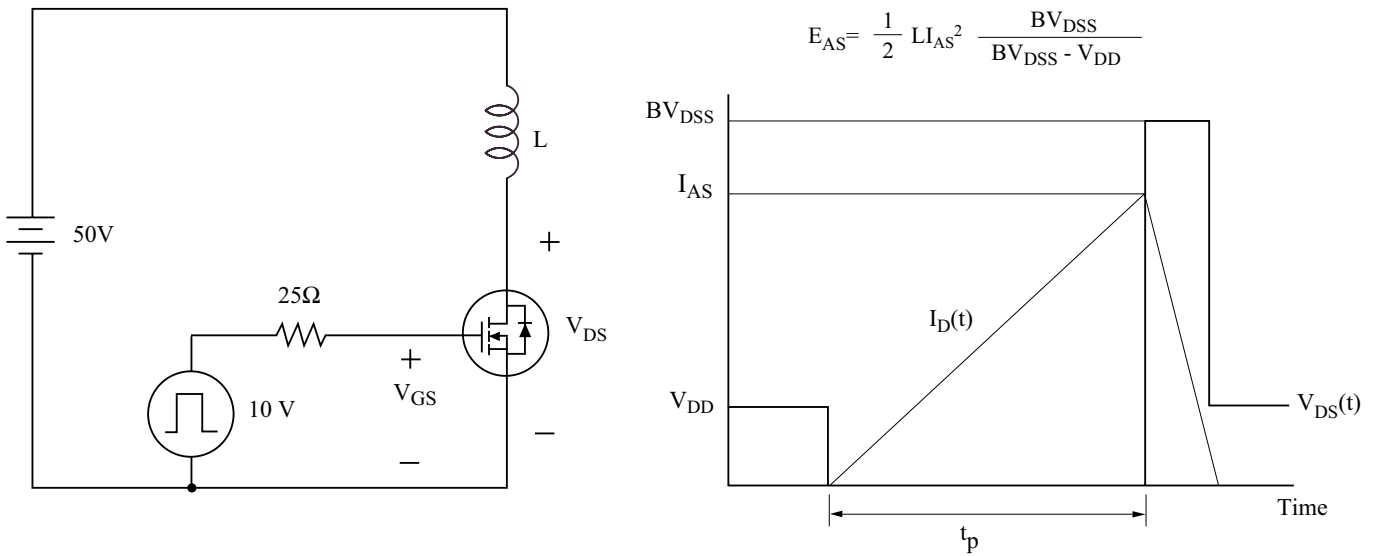

Fig14. Resistive Load Switching

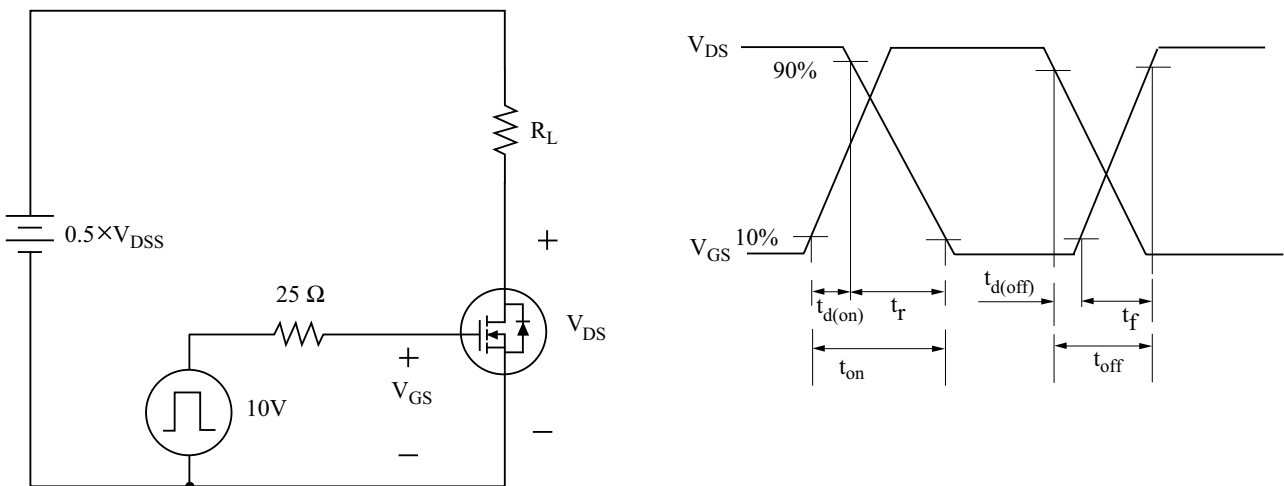

Fig15. Source - Drain Diode Reverse Recovery and dv/dt

