

GENERAL DESCRIPTION

This Trench MOSFET has better characteristics, such as fast switching time, low on resistance, low gate charge and excellent avalanche characteristics. It is mainly suitable for Battery pack.

FEATURES

- $V_{DSS} = -30V$, $I_D = -10A$.
- Drain-Source ON Resistance.
 $R_{DS(ON)} = 20m$ (Max.) @ $V_{GS} = -10V$
 $R_{DS(ON)} = 28m$ (Max.) @ $V_{GS} = -4.5V$
- Super High Dense Cell Design

MOSFET Maximum Ratings (Ta=25 Unless otherwise noted)

CHARACTERISTIC	SYMBOL	RATING	UNIT
Drain Source Voltage	V_{DSS}	-30	V
Gate Source Voltage	V_{GSS}	± 20	V
Drain Current	DC	I_D^*	-10 A
	Pulsed	I_{DP}	-80 A
Drain Source Diode Forward Current	I_S	-1.7	A
Drain Power Dissipation	P_D^*	2.0	W
Maximum Junction Temperature	T_j	150	
Storage Temperature Range	T_{stg}	-55~150	
Thermal Resistance, Junction to Ambient	R_{thJA}^*	62.5	/W

Note : *Surface Mounted on FR4 Board

PIN CONNECTION (TOP VIEW)

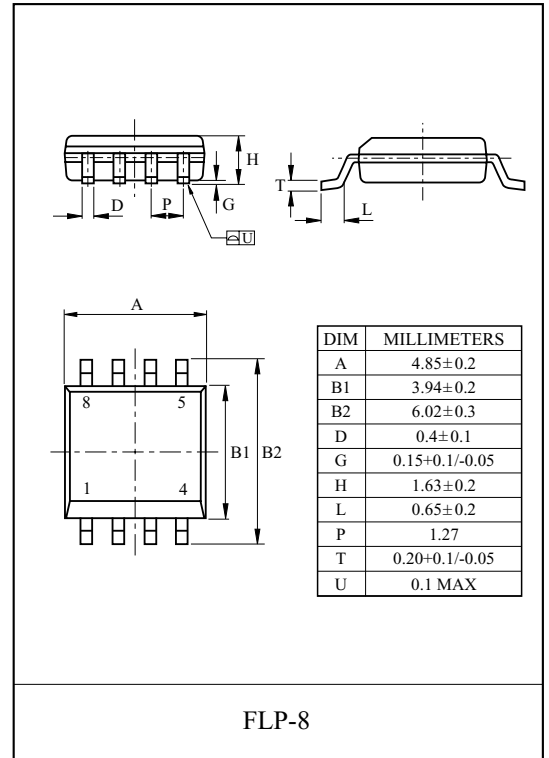
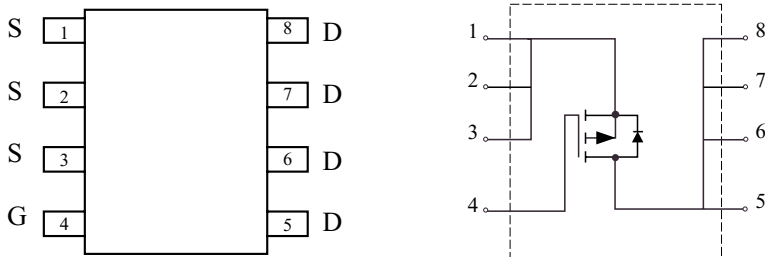

Marking

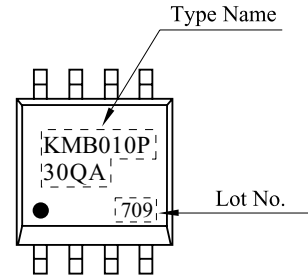

KMB010P30QA

ELECTRICAL CHARACTERISTICS (Ta=25) UNLESS OTHERWISE NOTED

CHARACTERISTIC	SYMBOL	TEST CONDITION	MIN.	TYP.	MAX.	UNIT
Static						
Drain-Source Breakdown Voltage	BV_{DSS}	$V_{GS}=0V, I_{DS}=-250\mu A$	-30	-	-	V
Drain Cut-off Current	I_{DSS}	$V_{DS}=-24V, V_{GS}=0V$	-	-	-1	μA
Gate Leakage Current	I_{GSS}	$V_{GS}=\pm 25V, V_{DS}=0V$	-	-	± 100	nA
Gate Threshold Voltage	V_{th}	$V_{DS}=V_{GS}, I_D=-250\mu A$	-1.3	-1.9	-2.5	V
Drain-Source ON Resistance	$R_{DS(ON)*}$	$V_{GS}=-10V, I_D=-10A$	-	12	20	m
		$V_{GS}=-4.5V, I_D=-8A$	-	20	28	
On-State Drain Current	$I_{D(ON)*}$	$V_{DS}=-5V, V_{GS}=-10V$	-30	-	-	A
Forward Transconductance	G_{fs*}	$V_{DS}=-15V, I_D=-10A$	-	14	-	S
Dynamic						
Input Capacitance	C_{iss}	$V_{DS}=-15V, V_{GS}=0V, f=1MHz$	-	2530	-	pF
Output Capacitance	C_{oss}		-	635	-	
Reverse Transfer Capacitance	C_{rss}		-	445	-	
Total Gate Charge	Q_g^*	$V_{DS}=-15V, V_{GS}=-10V, I_D=-10A$	-	44.6	-	nC
Gate-Source Charge	Q_{gs}^*		-	7.7	-	
Gate-Drain Charge	Q_{gd}^*		-	11.5	-	
Turn-On Delay Time	$t_{d(on)*}$	$V_{DD}=-15V, V_{GS}=-10V$ $R_L=1.25, R_G=6$	-	10.2	-	ns
Turn-On Rise Time	t_r^*		-	6.3	-	
Turn-Off Delay Time	$t_{d(off)*}$		-	22.5	-	
Turn-Off Fall Time	t_f^*		-	10.6	-	
Source-Drain Diode Ratings						
Source-Drain Forward Voltage	V_{SDF*}	$V_{GS}=0V, I_{DR}=-1.7A,$	-	-0.73	-1.2	V
Note						
1. Pulse Test : Pulse width 10 μs , Duty cycle 1%						

KMB010P30QA

Fig1. $I_D - V_{DS}$

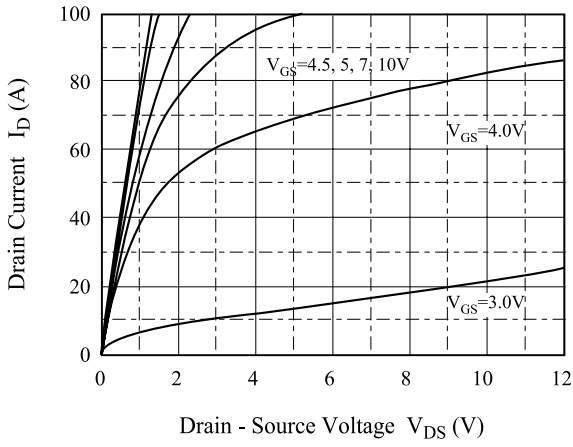

Fig2. $I_D - V_{GS}$

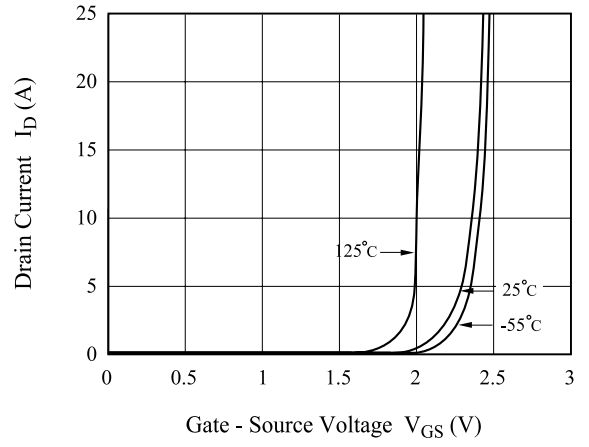

Fig3. $C - V_{DS}$

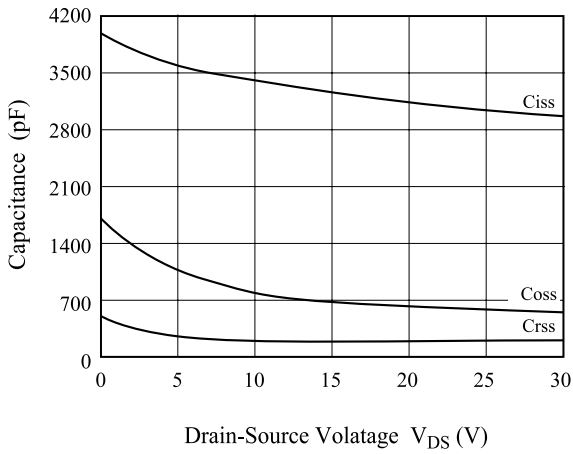

Fig4. $R_{DS(ON)} - T_j$

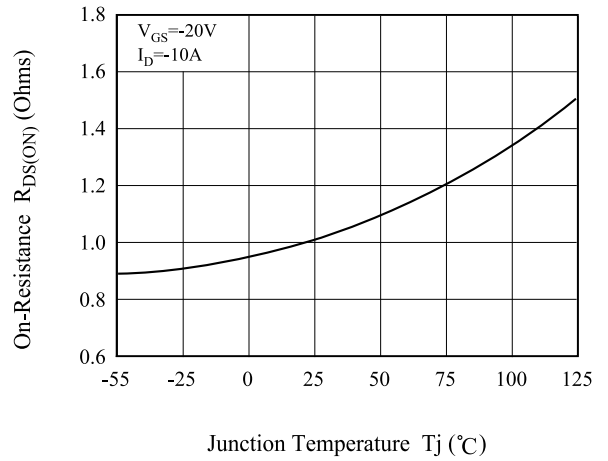

Fig5. $V_{th} - T_j$

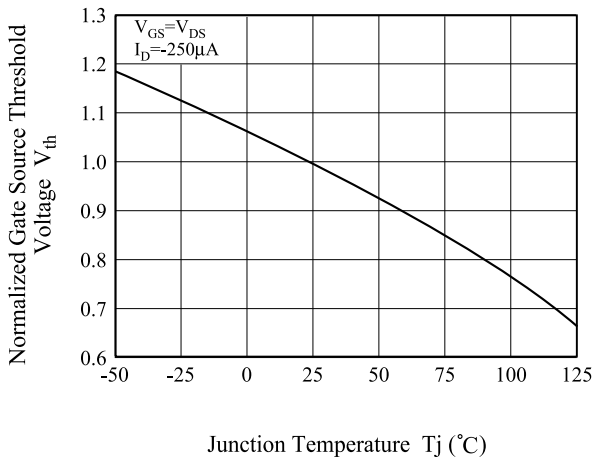
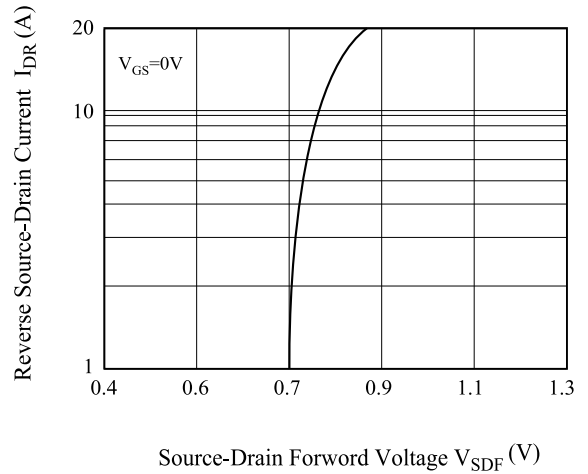

Fig 6. $I_{DR} - V_{SDF}$



KMB010P30QA

Fig7. $V_{GS} - Q_g$

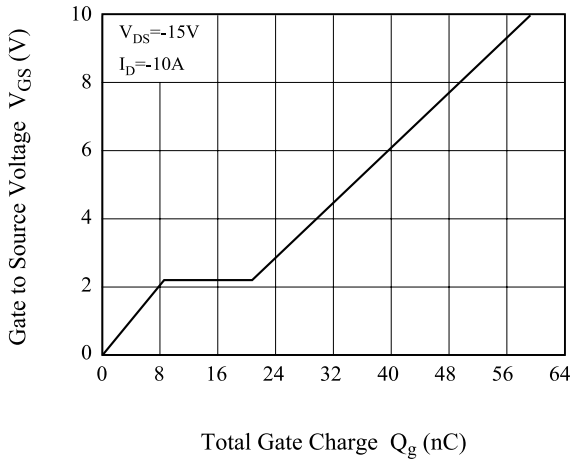

Fig8. Safe Operation Area

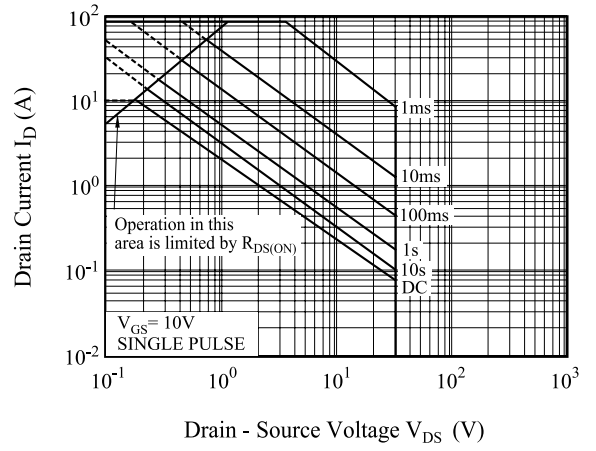

Fig9. Transient Thermal Response Curve

