

FDP2710 250V N-Channel PowerTrench MOSFET

General Description

This N-Channel MOSFET is produced using Fairchild Semiconductor's advanced PowerTrench process that has been especially tailored to minimize the on-state resistance and yet maintain superior switching performance.

Application

- PDP application



Description

- 50A, 250V, $R_{DS(on)} = 36.3m\Omega$ @ $V_{GS} = 10V$
- Fast switching speed
- Low gate charge
- High performance trench technology for extremely low $R_{DS(on)}$
- High power and current handling capability
- RoHS compliant

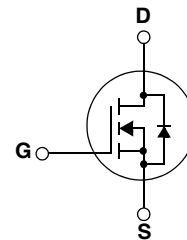
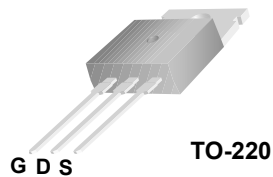

Absolute Maximum Ratings

Symbol	Parameter	Ratings	Unit
V_{DS}	Drain-Source Voltage	250	V
V_{GS}	Gate-Source voltage	± 30	V
I_D	Drain Current	- Continuous ($T_C = 25^\circ C$)	50
		- Continuous ($T_C = 100^\circ C$)	31.3
I_{DM}	Drain Current - Pulsed (Note 1)	See Figure 9	A
E_{AS}	Single Pulsed Avalanche Energy (Note 2)	145	mJ
dv/dt	Peak Diode Recovery dv/dt (Note 3)	4.5	V/ns
P_D	Power Dissipation ($T_C = 25^\circ C$)	- Derate above $25^\circ C$	260
			2.1
T_J, T_{STG}	Operating and Storage Temperature Range	-55 to +150	$^\circ C$
T_L	Maximum Lead Temperature for Soldering Purpose, 1/8" from Case for 5 Seconds	300	$^\circ C$

Thermal Characteristics

Symbol	Parameter	Min	Max	Unit
$R_{\theta JC}$	Thermal Resistance, Junction-to-Case	--	0.48	$^\circ C/W$
$R_{\theta JA}$	Thermal Resistance, Junction-to-Ambient	--	62.5	$^\circ C/W$

Package Marking and Ordering Information

Device Marking	Device	Package	Reel Size	Tape Width	Quantity
FDP2710	FDP2710	TO-220	-	-	50

Electrical Characteristics T_C = 25°C unless otherwise noted

Symbol	Parameter	Conditions	Min	Typ	Max	Units
Off Characteristics						
BV _{DSS}	Drain-Source Breakdown Voltage	V _{GS} = 0V, I _D = 250μA, T _J = 25°C	250	--	--	V
$\frac{\Delta BV_{DSS}}{\Delta T_J}$	Breakdown Voltage Temperature Coefficient	I _D = 250μA, Referenced to 25°C	--	0.25	--	V/°C
I _{DSS}	Zero Gate Voltage Drain Current	V _{DS} = 250V, V _{GS} = 0V V _{DS} = 250V, V _{GS} = 0V, T _C = 125°C	--	--	10 500	μA μA
I _{GSSF}	Gate-Body Leakage Current, Forward	V _{GS} = 30V, V _{DS} = 0V	--	--	100	nA
I _{GSSR}	Gate-Body Leakage Current, Reverse	V _{GS} = -30V, V _{DS} = 0V	--	--	-100	nA
On Characteristics						
V _{GS(th)}	Gate Threshold Voltage	V _{DS} = V _{GS} , I _D = 250μA	3.0	4.0	5.0	V
R _{DS(on)}	Static Drain-Source On-Resistance	V _{GS} = 10V, I _D = 25A	--	36.3	42.5	mΩ
g _{FS}	Forward Transconductance	V _{DS} = 10V, I _D = 25A (Note 4)	--	63	--	S
Dynamic Characteristics						
C _{iss}	Input Capacitance	V _{DS} = 25V, V _{GS} = 0V, f = 1.0MHz	--	5470	7280	pF
C _{oss}	Output Capacitance		--	426	570	pF
C _{rss}	Reverse Transfer Capacitance		--	97	146	pF
Switching Characteristics						
t _{d(on)}	Turn-On Delay Time	V _{DD} = 125V, I _D = 50A V _{GS} = 10V, R _{GEN} = 25Ω (Note 4, 5)	--	80	170	ns
t _r	Turn-On Rise Time		--	252	515	ns
t _{d(off)}	Turn-Off Delay Time		--	112	235	ns
t _f	Turn-Off Fall Time		--	154	320	ns
Q _g	Total Gate Charge	V _{DS} = 125V, I _D = 50A V _{GS} = 10V (Note 4, 5)	--	78	101	nC
Q _{gs}	Gate-Source Charge		--	34	--	nC
Q _{gd}	Gate-Drain Charge		--	18	--	nC
Drain-Source Diode Characteristics and Maximum Ratings						
I _S	Maximum Continuous Drain-Source Diode Forward Current		--	--	50	A
I _{SM}	Maximum Pulsed Drain-Source Diode Forward Current		--	--	150	A
V _{SD}	Drain-Source Diode Forward Voltage	V _{GS} = 0V, I _S = 50A	--	--	1.2	V
t _{rr}	Reverse Recovery Time	V _{GS} = 0V, I _S = 50A	--	163	--	ns
Q _{rr}	Reverse Recovery Charge	dI _F /dt = 100A/μs (Note 4)	--	1.3	--	μC

Notes:

1. Repetitive Rating: Pulse width limited by maximum junction temperature
2. L = 1mH, I_{AS} = 17A, V_{DD} = 50V, R_G = 25Ω, Starting T_J = 25°C
3. I_{SD} ≤ 50A, di/dt ≤ 100A/μs, V_{DD} ≤ BV_{DSS}, Starting T_J = 25°C
4. Pulse Test: Pulse width ≤ 300μs, Duty Cycle ≤ 2%
5. Essentially Independent of Operating Temperature Typical Characteristics

Typical Performance Characteristics

Figure 1. On-Region Characteristics

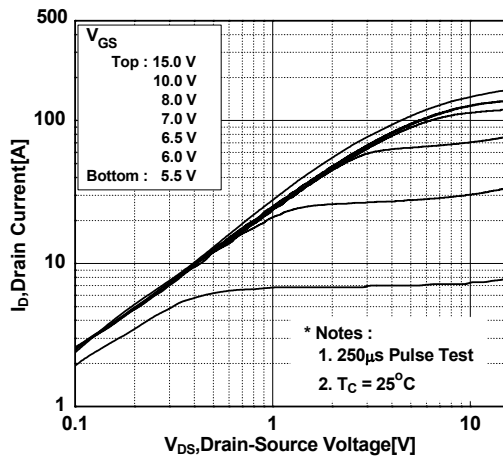

Figure 2. Transfer Characteristics

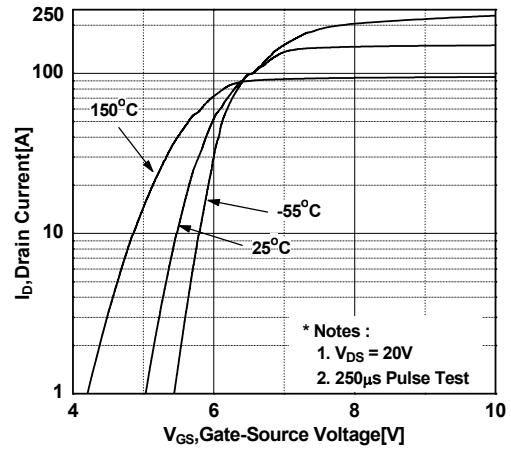

Figure 3. On-Resistance Variation vs. Drain Current and Gate Voltage

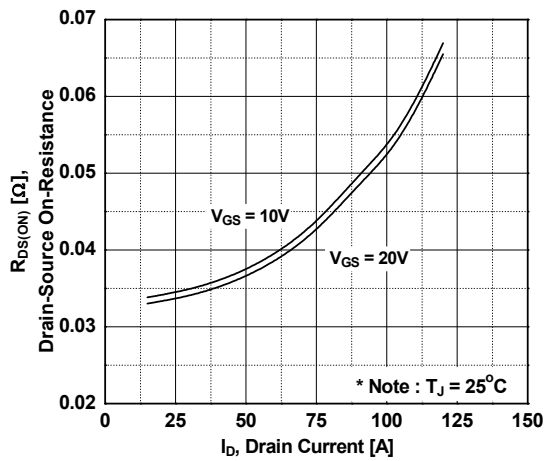

Figure 4. Body Diode Forward Voltage Variation vs. Source Current and Temperature

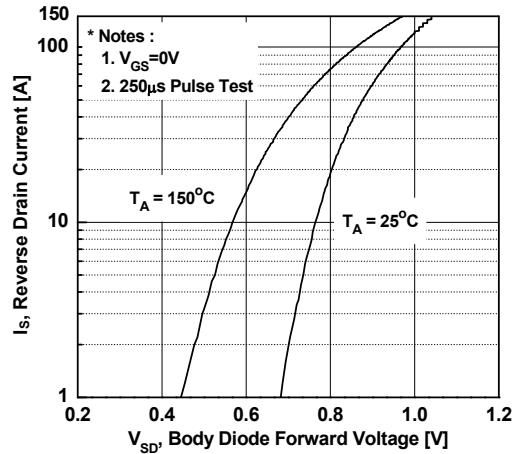

Figure 5. Capacitance Characteristics

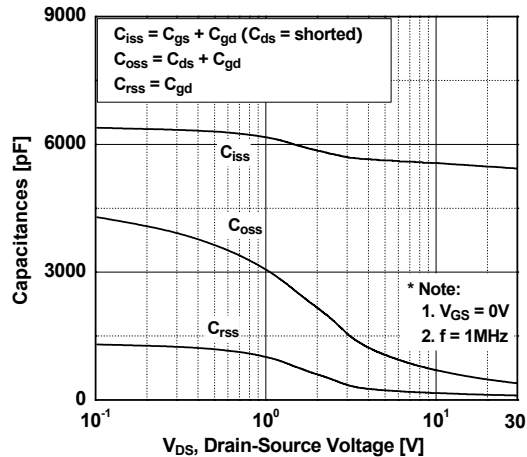
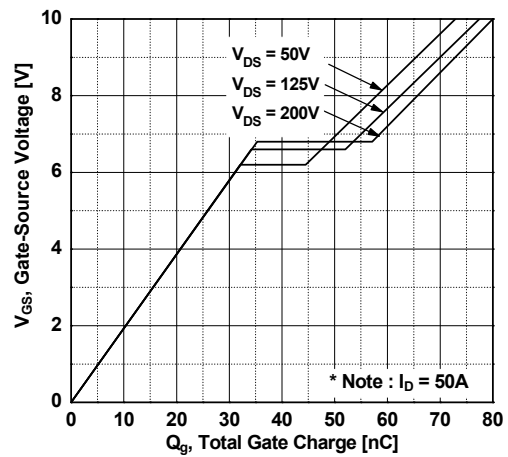

Figure 6. Gate Charge Characteristics



Typical Performance Characteristics (Continued)

Figure 7. Breakdown Voltage Variation vs. Temperature

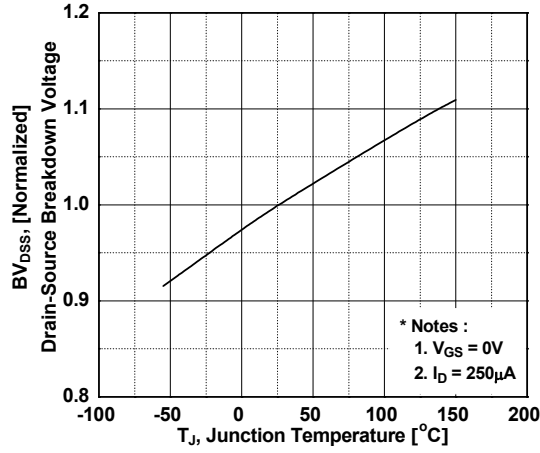

Figure 8. On-Resistance Variation vs. Temperature

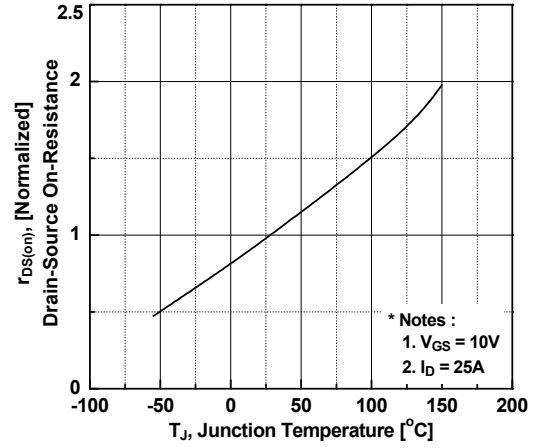

Figure 9. Maximum Safe Operating Area

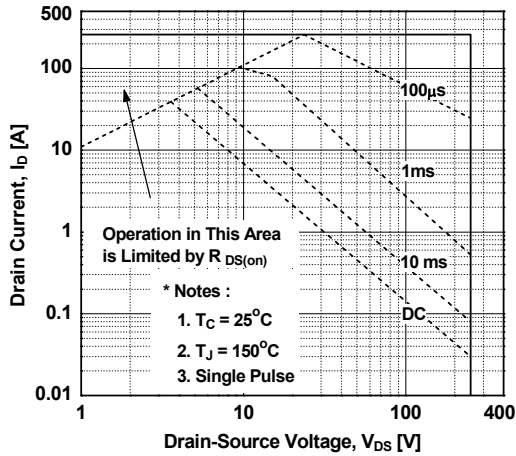

Figure 10. Maximum Drain Current vs. Case Temperature

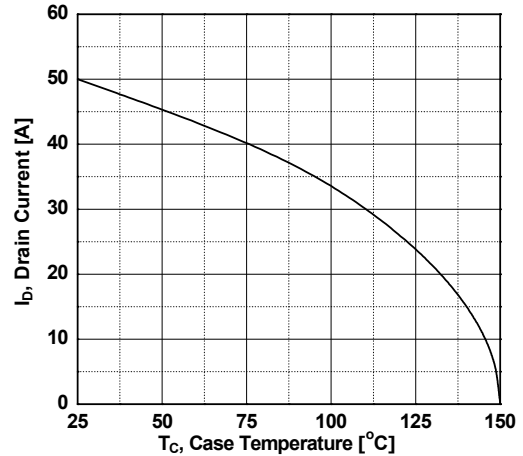
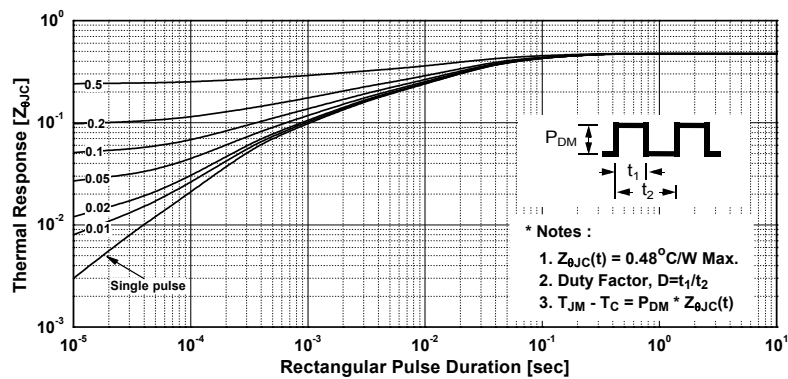
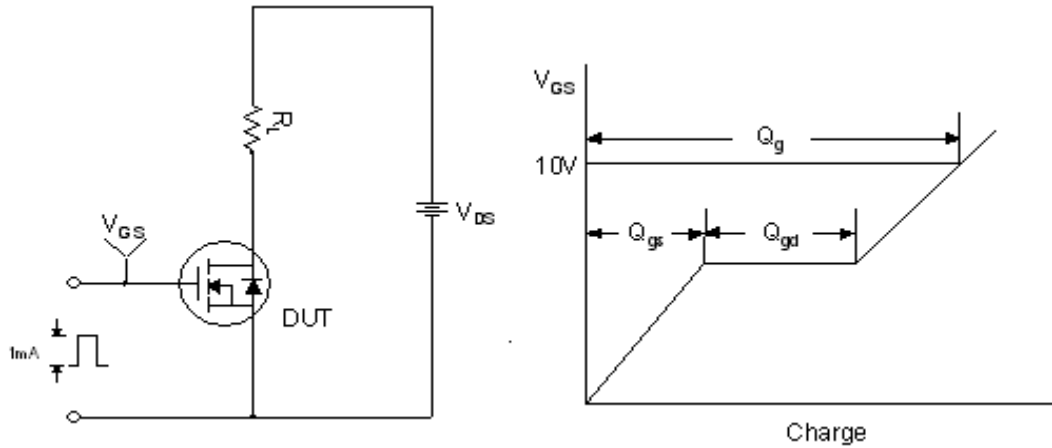

Figure 11. Transient Thermal Response Curve



Gate Charge Test Circuit & Waveform



Resistive Switching Test Circuit & Waveforms

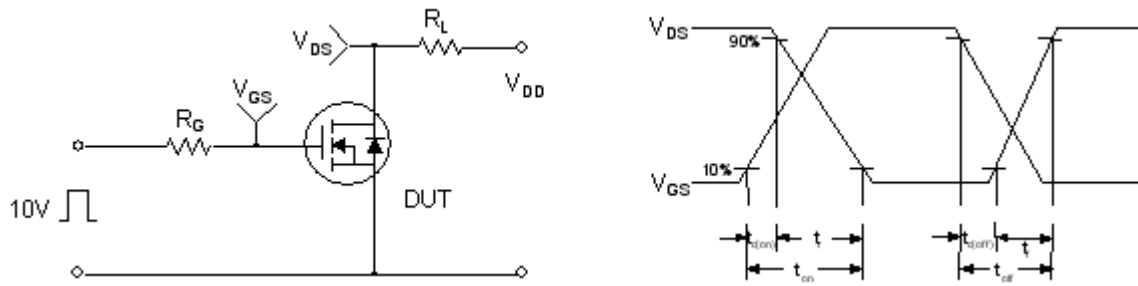

Unclamped Inductive Switching Test Circuit & Waveforms

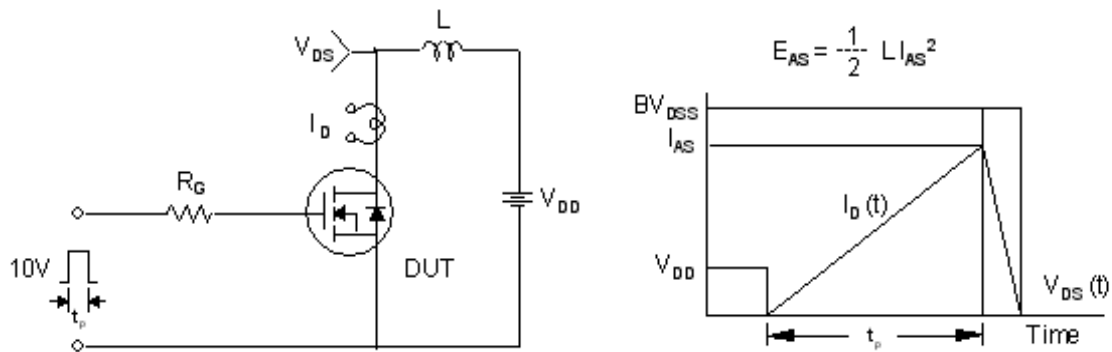

Peak Diode Recovery dv/dt Test Circuit & Waveforms





TRADEMARKS

The following are registered and unregistered trademarks and service marks Fairchild Semiconductor owns or is authorized to use and is not intended to be an exhaustive list of all such trademarks.

- | | | | |
|--------------------------------------|--|--|----------------------------------|
| ACEX [®] | Green FPS [™] | Power247 [®] | SuperSOT [™] -8 |
| Build it Now [™] | Green FPS [™] e-Series [™] | POWEREDGE [®] | SyncFET [™] |
| CorePLUS [™] | GTO [™] | Power-SPM [™] | The Power Franchise [®] |
| CROSSVOLT [™] | <i>i-Lo</i> [™] | PowerTrench [®] | power
franchise |
| CTL [™] | IntelliMAX [™] | Programmable Active Droop [™] | QFET [®] |
| Current Transfer Logic [™] | ISOPLANAR [™] | QS [™] | TinyBoost [™] |
| EcoSPARK [®] | MegaBuck [™] | QT Optoelectronics [™] | TinyBuck [™] |
| F [®] | MICROCOUPLER [™] | Quiet Series [™] | TinyLogic [®] |
| Fairchild [®] | MicroFET [™] | RapidConfigure [™] | TINYOPTO [™] |
| Fairchild Semiconductor [®] | MicroPak [™] | SMART START [™] | TinyPower [™] |
| FACT Quiet Series [™] | MillerDrive [™] | SPM [®] | TinyPWM [™] |
| FACT [®] | Motion-SPM [™] | STEALTH [™] | TinyWire [™] |
| FAST [®] | OPTOLOGIC [®] | SuperFET [™] | μSerDes [™] |
| FastvCore [™] | OPTOPLANAR [®] | SuperSOT [™] -3 | UHC [®] |
| FPS [™] |  [®] | SuperSOT [™] -6 | UniFET [™] |
| FRFET [®] | PDP-SPM [™] | | VCX [™] |
| Global Power Resource SM | Power220 [®] | | |

DISCLAIMER

FAIRCHILD SEMICONDUCTOR RESERVES THE RIGHT TO MAKE CHANGES WITHOUT FURTHER NOTICE TO ANY PRODUCTS HEREIN TO IMPROVE RELIABILITY, FUNCTION, OR DESIGN. FAIRCHILD DOES NOT ASSUME ANY LIABILITY ARISING OUT OF THE APPLICATION OR USE OF ANY PRODUCT OR CIRCUIT DESCRIBED HEREIN; NEITHER DOES IT CONVEY ANY LICENSE UNDER ITS PATENT RIGHTS, NOR THE RIGHTS OF OTHERS. THESE SPECIFICATIONS DO NOT EXPAND THE TERMS OF FAIRCHILD'S WORLDWIDE TERMS AND CONDITIONS, SPECIFICALLY THE WARRANTY THEREIN, WHICH COVERS THESE PRODUCTS.

LIFE SUPPORT POLICY

FAIRCHILD'S PRODUCTS ARE NOT AUTHORIZED FOR USE AS CRITICAL COMPONENTS IN LIFE SUPPORT DEVICES OR SYSTEMS WITHOUT THE EXPRESS WRITTEN APPROVAL OF FAIRCHILD SEMICONDUCTOR CORPORATION.

As used herein:

- Life support devices or systems are devices or systems which, (a) are intended for surgical implant into the body or (b) support or sustain life, and (c) whose failure to perform when properly used in accordance with instructions for use provided in the labeling, can be reasonably expected to result in a significant injury to the user.
- A critical component in any component of a life support, device, or system whose failure to perform can be reasonably expected to cause the failure of the life support device or system, or to affect its safety or effectiveness.

PRODUCT STATUS DEFINITIONS

Definition of Terms

Datasheet Identification	Product Status	Definition
Advance Information	Formative or In Design	This datasheet contains the design specifications for product development. Specifications may change in any manner without notice.
Preliminary	First Production	This datasheet contains preliminary data; supplementary data will be published at a later date. Fairchild Semiconductor reserves the right to make changes at any time without notice to improve design.
No Identification Needed	Full Production	This datasheet contains final specifications. Fairchild Semiconductor reserves the right to make changes at any time without notice to improve design.
Obsolete	Not In Production	This datasheet contains specifications on a product that has been discontinued by Fairchild Semiconductor. The datasheet is printed for reference information only.