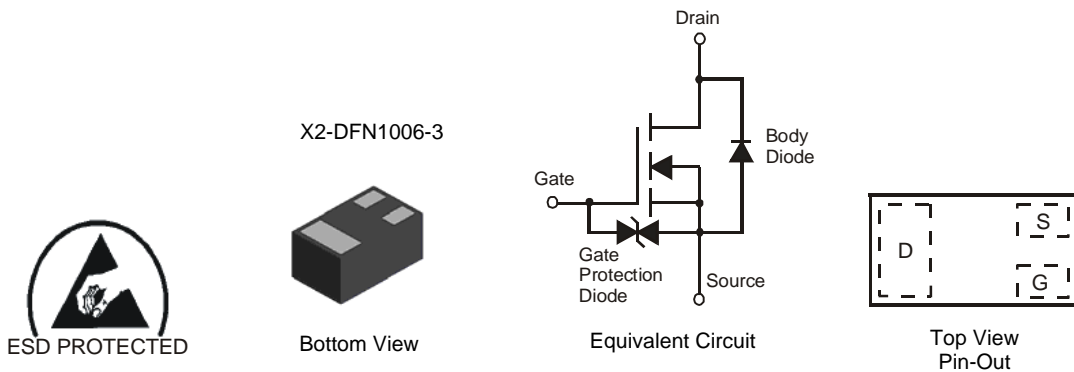

Features

- Low On-Resistance
- Very Low Gate Threshold Voltage, 0.9V Max.
- Fast Switching Speed
- Low Input/Output Leakage
- Ultra-Small Surface Mount Package
- **Totally Lead-Free & Fully RoHS Compliant (Notes 1 & 2)**
- **Halogen and Antimony Free. "Green" Device (Note 3)**
- **ESD Protected Gate**
- **Ultra Low Profile Package**
- **Qualified to AEC-Q101 Standards for High Reliability**

Mechanical Data

- Case: X2-DFN1006-3
- Case Material: Molded Plastic, "Green" Molding Compound. UL Flammability Classification Rating 94V-0
- Moisture Sensitivity: Level 1 per J-STD-020
- Terminal Connections: See Diagram
- Terminals: Finish — NiPdAu over Copper leadframe. Solderable per MIL-STD-202, Method 208 (64)
- Weight: 0.001 grams

Ordering Information (Note 4)

Part Number	Marking	Reel size (inches)	Tape width (mm)	Quantity per reel
DMN2005LP4K-7	DN	7	8	3000
DMN2005LP4K-7B	DN	7	8	10,000

- Notes:
1. No purposely added lead. Fully EU Directive 2002/95/EC (RoHS) & 2011/65/EU (RoHS 2) compliant.
 2. See <http://www.diodes.com> for more information about Diodes Incorporated's definitions of Halogen- and Antimony-free, "Green" and Lead-free.
 3. Halogen- and Antimony-free "Green" products are defined as those which contain <900ppm bromine, <900ppm chlorine (<1500ppm total Br + Cl) and <1000ppm antimony compounds.
 4. For packaging details, go to our website at <http://www.diodes.com>.

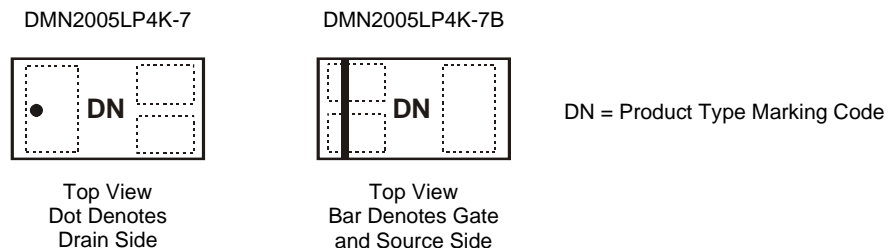
Marking Information

Maximum Ratings (@T_A = 25°C unless otherwise specified.)

Characteristic	Symbol	Value	Unit
Drain-Source Voltage	V _{DSS}	20	V
Gate-Source Voltage	V _{GSS}	±10	V
Drain Current per element (Note 5)	I _D	Continuous	300
		Pulsed (Note 6)	350

Thermal Characteristics

Characteristic	Symbol	Value	Unit
Total Power Dissipation (Note 5)	P _D	400	mW
Thermal Resistance, Junction to Ambient	R _{θJA}	280	°C/W
Operating and Storage Temperature Range	T _J , T _{STG}	-65 to +150	°C

Electrical Characteristics (@T_A = 25°C unless otherwise specified.)

Characteristic	Symbol	Min	Typ	Max	Unit	Test Condition
OFF CHARACTERISTICS (per element) (Note 7)						
Drain-Source Breakdown Voltage	BV _{DSS}	20	—	—	V	V _{GS} = 0V, I _D = 100μA
Zero Gate Voltage Drain Current	I _{DSS}	—	—	10	μA	V _{DS} = 17V, V _{GS} = 0V
Gate-Source Leakage	I _{GSS}	—	—	±5	μA	V _{GS} = ±8V, V _{DS} = 0V
ON CHARACTERISTICS (per element) (Note 7)						
Gate Threshold Voltage	V _{GS(th)}	0.53	—	0.9	V	V _{DS} = V _{GS} , I _D = 100μA
Static Drain-Source On-Resistance	R _{DS(on)}	—	0.35	1.5	Ω	V _{GS} = 4V, I _D = 10mA
		—	0.4	1.7		V _{GS} = 2.7V, I _D = 200mA
		—	0.45	1.7		V _{GS} = 2.5V, I _D = 10mA
		—	0.55	3.5		V _{GS} = 1.8V, I _D = 200mA
		—	0.65	3.5		V _{GS} = 1.5V, I _D = 1mA
Forward Transfer Admittance	Y _{fs}	40	—	—	mS	V _{DS} = 3V, I _D = 10mA
DYNAMIC CHARACTERISTICS						
Input Capacitance	C _{iss}	—	37.1	—	pF	V _{DS} = 10V, V _{GS} = 0V f = 1.0MHz
Output Capacitance	C _{oss}	—	6.5	—	pF	
Reverse Transfer Capacitance	C _{rss}	—	4.8	—	pF	
Switching Time	Turn-on Time	t _{on}	—	4.06	nS	V _{DD} = 10V, R _I = 47Ω, V _{GEN} = 4.5V, R _{GEN} = 10Ω.
	Turn-off Time	t _{off}	—	13.7		

- Notes: 5. Device mounted on FR-4 PCB.
6. Pulse width ≤10μs, Duty Cycle ≤1%.
7. Short duration pulse test used to minimize self-heating effect.

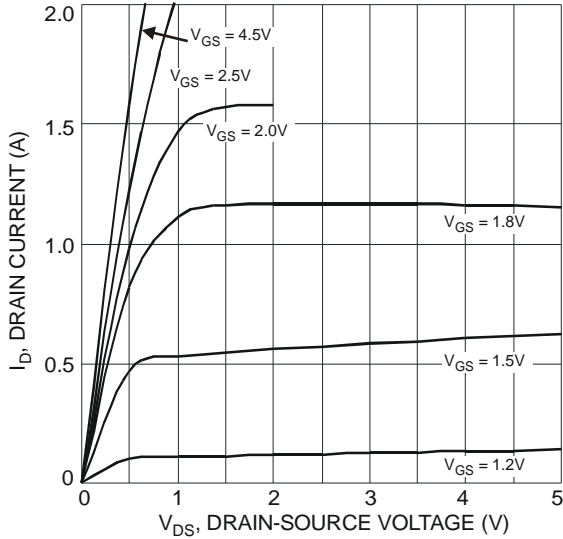

Fig. 1 Typical Output Characteristics

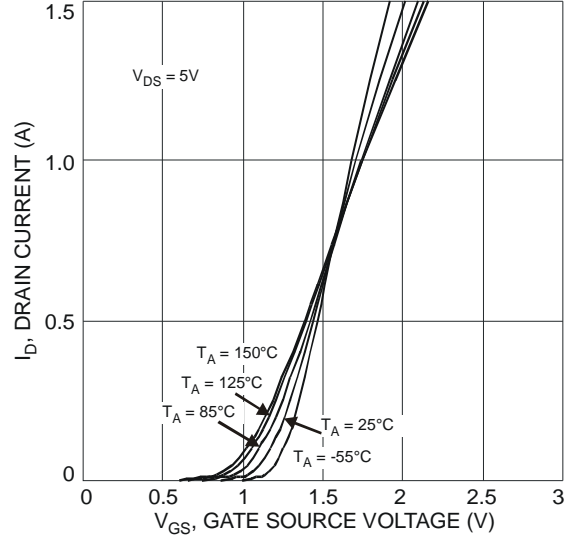

Fig. 2 Typical Transfer Characteristics

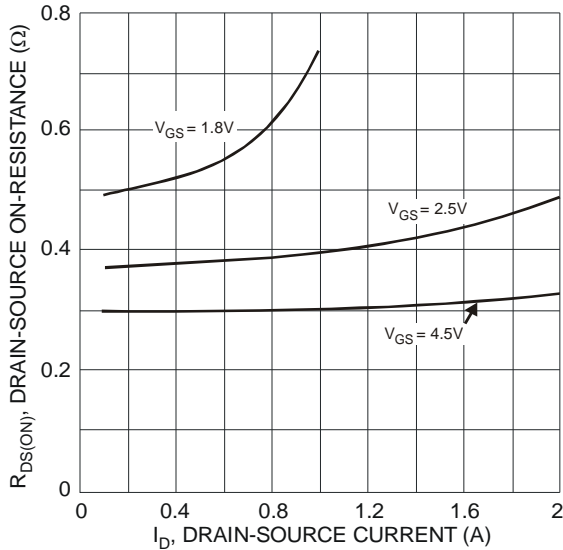

Fig. 3 Typical On-Resistance vs. Drain Current and Gate Voltage

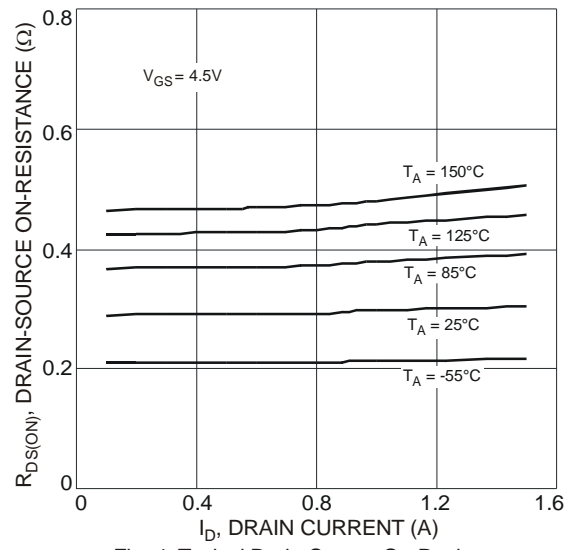

Fig. 4 Typical Drain-Source On-Resistance vs. Drain Current and Temperature

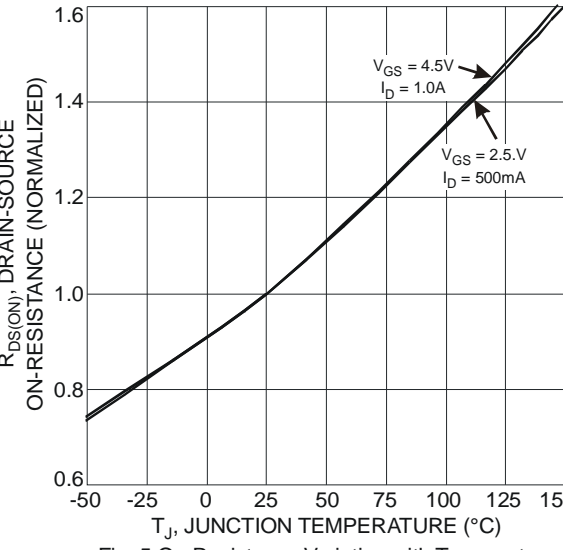

Fig. 5 On-Resistance Variation with Temperature

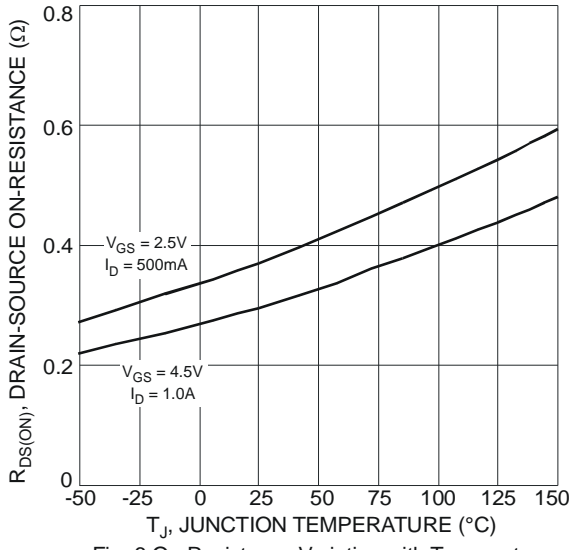

Fig. 6 On-Resistance Variation with Temperature

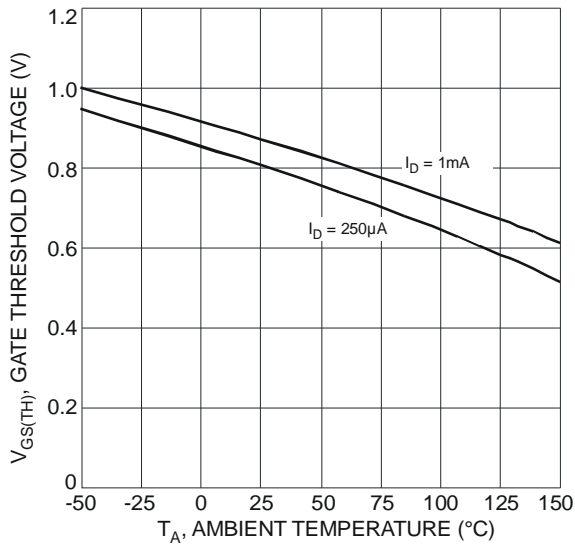

Fig. 7 Gate Threshold Variation vs. Ambient Temperature

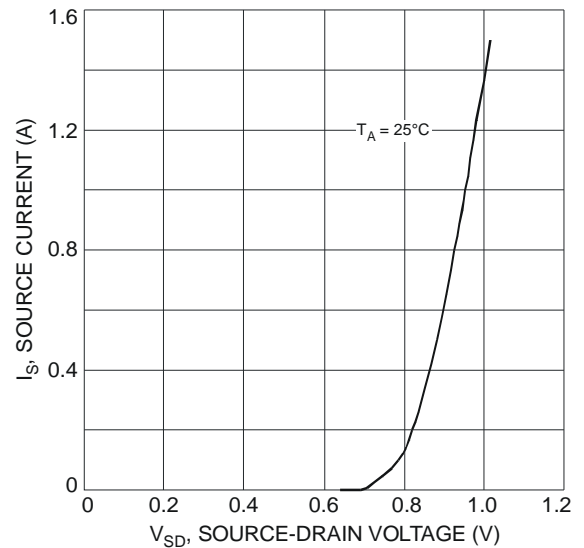

Fig. 8 Diode Forward Voltage vs. Current

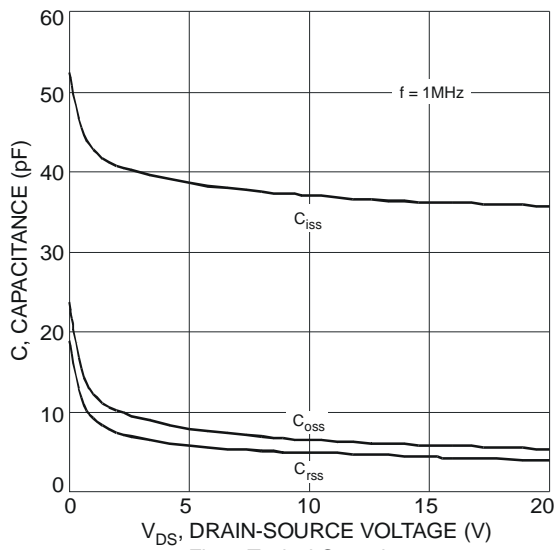
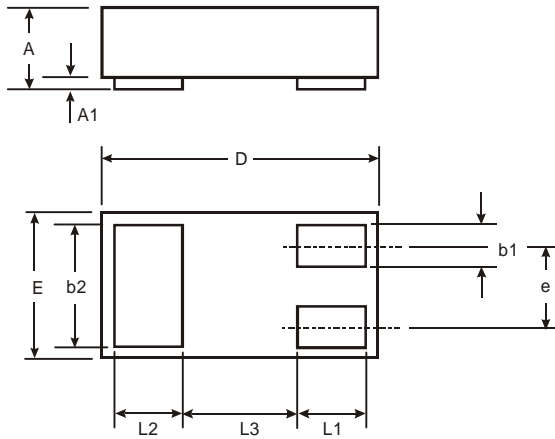

Fig. 9 Typical Capacitance

Package Outline Dimensions



X2-DFN1006-3			
Dim	Min	Max	Typ
A	—	0.40	—
A1	0	0.05	0.03
b1	0.10	0.20	0.15
b2	0.45	0.55	0.50
D	0.95	1.05	1.00
E	0.55	0.65	0.60
e	—	—	0.35
L1	0.20	0.30	0.25
L2	0.20	0.30	0.25
L3	—	—	0.40
All Dimensions in mm			

Suggested Pad Layout

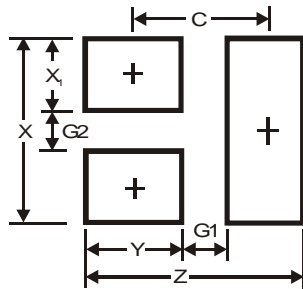

Dimensions	Value (in mm)
Z	1.1
G1	0.3
G2	0.2
X	0.7
X1	0.25
Y	0.4
C	0.7

IMPORTANT NOTICE

DIODES INCORPORATED MAKES NO WARRANTY OF ANY KIND, EXPRESS OR IMPLIED, WITH REGARDS TO THIS DOCUMENT, INCLUDING, BUT NOT LIMITED TO, THE IMPLIED WARRANTIES OF MERCHANTABILITY AND FITNESS FOR A PARTICULAR PURPOSE (AND THEIR EQUIVALENTS UNDER THE LAWS OF ANY JURISDICTION).

Diodes Incorporated and its subsidiaries reserve the right to make modifications, enhancements, improvements, corrections or other changes without further notice to this document and any product described herein. Diodes Incorporated does not assume any liability arising out of the application or use of this document or any product described herein; neither does Diodes Incorporated convey any license under its patent or trademark rights, nor the rights of others. Any Customer or user of this document or products described herein in such applications shall assume all risks of such use and will agree to hold Diodes Incorporated and all the companies whose products are represented on Diodes Incorporated website, harmless against all damages.

Diodes Incorporated does not warrant or accept any liability whatsoever in respect of any products purchased through unauthorized sales channel. Should Customers purchase or use Diodes Incorporated products for any unintended or unauthorized application, Customers shall indemnify and hold Diodes Incorporated and its representatives harmless against all claims, damages, expenses, and attorney fees arising out of, directly or indirectly, any claim of personal injury or death associated with such unintended or unauthorized application.

Products described herein may be covered by one or more United States, international or foreign patents pending. Product names and markings noted herein may also be covered by one or more United States, international or foreign trademarks.

LIFE SUPPORT

Diodes Incorporated products are specifically not authorized for use as critical components in life support devices or systems without the express written approval of the Chief Executive Officer of Diodes Incorporated. As used herein:

A. Life support devices or systems are devices or systems which:

1. are intended to implant into the body, or
2. support or sustain life and whose failure to perform when properly used in accordance with instructions for use provided in the labeling can be reasonably expected to result in significant injury to the user.

B. A critical component is any component in a life support device or system whose failure to perform can be reasonably expected to cause the failure of the life support device or to affect its safety or effectiveness.

Customers represent that they have all necessary expertise in the safety and regulatory ramifications of their life support devices or systems, and acknowledge and agree that they are solely responsible for all legal, regulatory and safety-related requirements concerning their products and any use of Diodes Incorporated products in such safety-critical, life support devices or systems, notwithstanding any devices- or systems-related information or support that may be provided by Diodes Incorporated. Further, Customers must fully indemnify Diodes Incorporated and its representatives against any damages arising out of the use of Diodes Incorporated products in such safety-critical, life support devices or systems.

Copyright © 2012, Diodes Incorporated

www.diodes.com