

NDF06N60Z

N-Channel Power MOSFET 600 V, 1.2 Ω

Features

- Low ON Resistance
- Low Gate Charge
- ESD Diode-Protected Gate
- 100% Avalanche Tested
- These Devices are Pb-Free, Halogen Free/BFR Free and are RoHS Compliant

ABSOLUTE MAXIMUM RATINGS ($T_C = 25^\circ\text{C}$ unless otherwise noted)

Rating	Symbol	Value	Unit
Drain-to-Source Voltage	V_{DSS}	600	V
Continuous Drain Current, $R_{\theta JC}$ (Note 1)	I_D	7.1	A
Continuous Drain Current $T_A = 100^\circ\text{C}$, $R_{\theta JC}$ (Note 1)	I_D	4.5	A
Pulsed Drain Current, $V_{GS} @ 10\text{ V}$	I_{DM}	28	A
Power Dissipation, $R_{\theta JC}$	P_D	35	W
Gate-to-Source Voltage	V_{GS}	± 30	V
Single Pulse Avalanche Energy, $L = 6.3\text{ mH}$, $I_D = 6.0\text{ A}$	E_{AS}	113	mJ
ESD (HBM) (JESD22-A114)	V_{esd}	3000	V
RMS Isolation Voltage ($t = 0.3\text{ sec.}$, R.H. $\leq 30\%$, $T_A = 25^\circ\text{C}$) (Figure 13)	V_{ISO}	4500	V
Peak Diode Recovery (Note 2)	dv/dt	4.5	V/ns
Continuous Source Current (Body Diode)	I_S	6.0	A
Maximum Temperature for Soldering Leads	T_L	260	$^\circ\text{C}$
Operating Junction and Storage Temperature Range	T_J, T_{stg}	-55 to 150	$^\circ\text{C}$

Stresses exceeding Maximum Ratings may damage the device. Maximum Ratings are stress ratings only. Functional operation above the Recommended Operating Conditions is not implied. Extended exposure to stresses above the Recommended Operating Conditions may affect device reliability.

1. Limited by maximum junction temperature
2. $I_{SD} = 6.0\text{ A}$, $di/dt \leq 100\text{ A}/\mu\text{s}$, $V_{DD} \leq BV_{DSS}$, $T_J = +150^\circ\text{C}$



ON Semiconductor[®]

<http://onsemi.com>

V_{DSS} (@ T_{Jmax})	$R_{DS(ON)}$ (MAX) @ 3 A
650 V	1.2 Ω

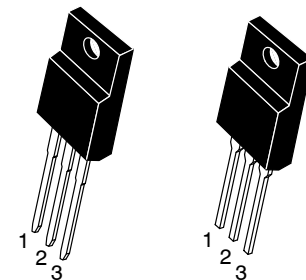
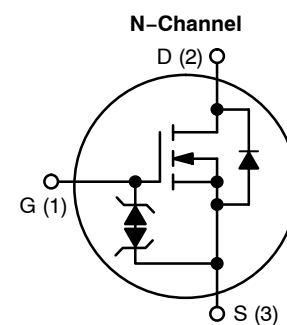

NDF06N60ZG
TO-220FP
CASE 221D

NDF06N60ZH
TO-220FP
CASE 221AH

ORDERING AND MARKING INFORMATION

See detailed ordering, marking and shipping information in the package dimensions section on page 6 of this data sheet.

NDF06N60Z

THERMAL RESISTANCE

Parameter	Symbol	Value	Unit
Junction-to-Case (Drain)	$R_{\theta JC}$	3.6	°C/W
Junction-to-Ambient Steady State (Note 3)	$R_{\theta JA}$	50	

3. Insertion mounted

ELECTRICAL CHARACTERISTICS ($T_J = 25^\circ\text{C}$ unless otherwise noted)

Characteristic	Test Conditions	Symbol	Min	Typ	Max	Unit
----------------	-----------------	--------	-----	-----	-----	------

OFF CHARACTERISTICS

Drain-to-Source Breakdown Voltage	$V_{GS} = 0\text{ V}, I_D = 1\text{ mA}$	BV_{DSS}	600			V
Breakdown Voltage Temperature Coefficient	Reference to 25°C , $I_D = 1\text{ mA}$	$\Delta BV_{DSS}/\Delta T_J$		0.6		V/°C
Drain-to-Source Leakage Current	$V_{DS} = 600\text{ V}, V_{GS} = 0\text{ V}$	I_{DSS}			1	μA
					50	
Gate-to-Source Forward Leakage	$V_{GS} = \pm 20\text{ V}$	I_{GSS}			±10	μA

ON CHARACTERISTICS (Note 4)

Static Drain-to-Source On-Resistance	$V_{GS} = 10\text{ V}, I_D = 3.0\text{ A}$	$R_{DS(on)}$		0.98	1.2	Ω
Gate Threshold Voltage	$V_{DS} = V_{GS}, I_D = 100\text{ }\mu\text{A}$	$V_{GS(th)}$	3.0	3.9	4.5	V
Forward Transconductance	$V_{DS} = 15\text{ V}, I_D = 3.0\text{ A}$	g_{FS}		5.0		S

DYNAMIC CHARACTERISTICS

Input Capacitance (Note 5)	$V_{DS} = 25\text{ V}, V_{GS} = 0\text{ V},$ $f = 1.0\text{ MHz}$	C_{iss}	738	923	1107	pF
Output Capacitance (Note 5)		C_{oss}	90	106	125	
Reverse Transfer Capacitance (Note 5)		C_{rss}	15	23	30	
Total Gate Charge (Note 5)	$V_{DD} = 300\text{ V}, I_D = 6.0\text{ A},$ $V_{GS} = 10\text{ V}$	Q_g	15.5	31	47	nC
Gate-to-Source Charge (Note 5)		Q_{gs}	3	6.3	9.5	
Gate-to-Drain ("Miller") Charge (Note 5)		Q_{gd}	8	17	24.5	
Plateau Voltage		V_{GP}		6.4		V
Gate Resistance		R_g		3.2		Ω

RESISTIVE SWITCHING CHARACTERISTICS

Turn-On Delay Time	$V_{DD} = 300\text{ V}, I_D = 6.0\text{ A},$ $V_{GS} = 10\text{ V}, R_G = 5\text{ }\Omega$	$t_{d(on)}$		13		ns
Rise Time		t_r		17		
Turn-Off Delay Time		$t_{d(off)}$		30		
Fall Time		t_f		28		

SOURCE-DRAIN DIODE CHARACTERISTICS ($T_C = 25^\circ\text{C}$ unless otherwise noted)

Diode Forward Voltage	$I_S = 6.0\text{ A}, V_{GS} = 0\text{ V}$	V_{SD}			1.6	V
Reverse Recovery Time	$V_{GS} = 0\text{ V}, V_{DD} = 30\text{ V}$ $I_S = 6.0\text{ A}, di/dt = 100\text{ A}/\mu\text{s}$	t_{rr}		338		ns
Reverse Recovery Charge		Q_{rr}		2.0		μC

4. Pulse Width $\leq 380\text{ }\mu\text{s}$, Duty Cycle $\leq 2\%$.

5. Guaranteed by design.

TYPICAL CHARACTERISTICS

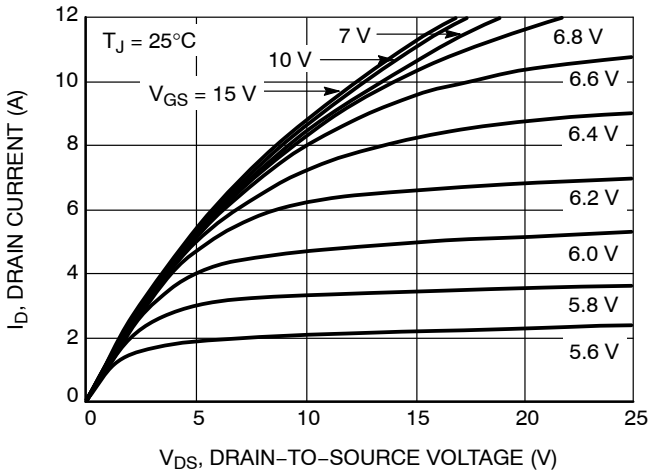

Figure 1. On-Region Characteristics

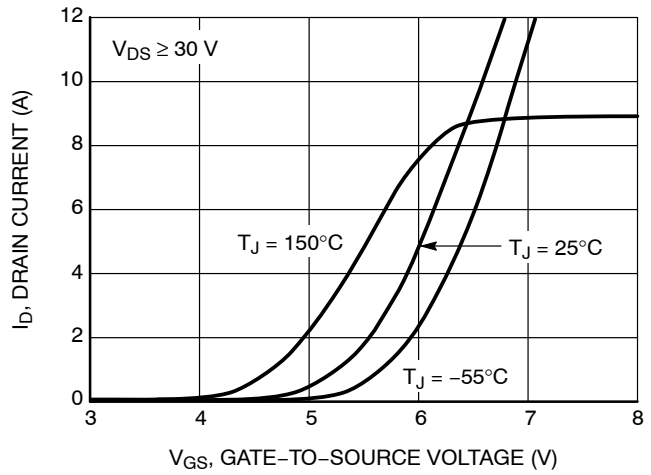

Figure 2. Transfer Characteristics

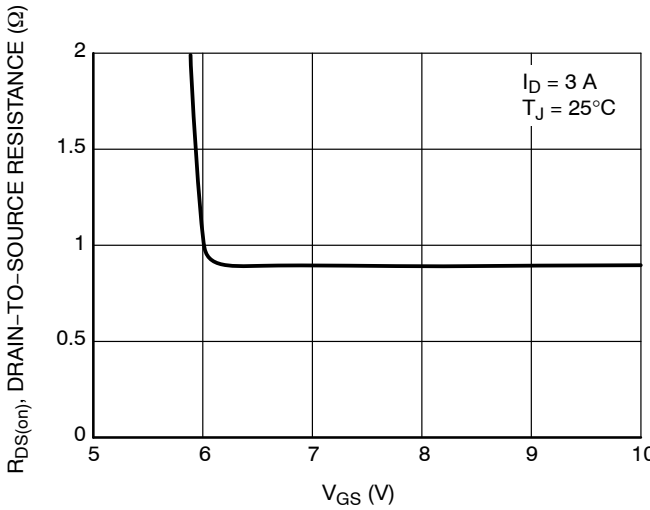

Figure 3. On-Resistance vs. V_{GS}

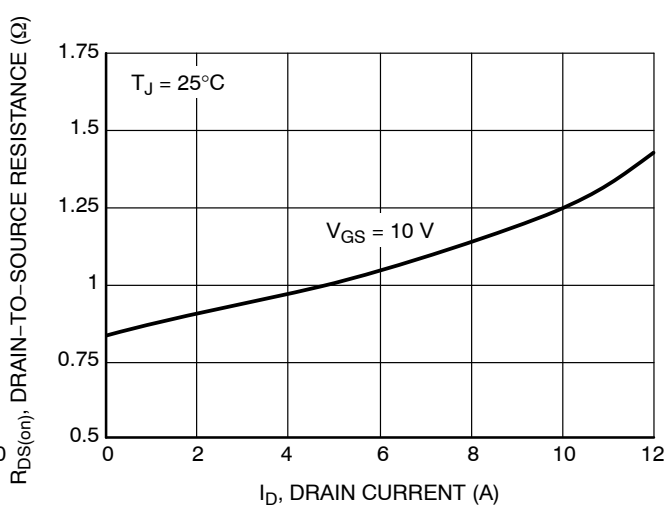

Figure 4. On-Resistance vs. Drain Current and Gate Voltage

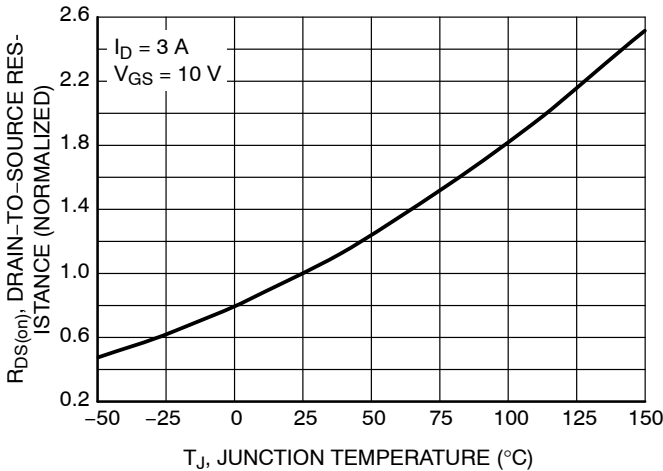

Figure 5. On-Resistance Variation with Temperature

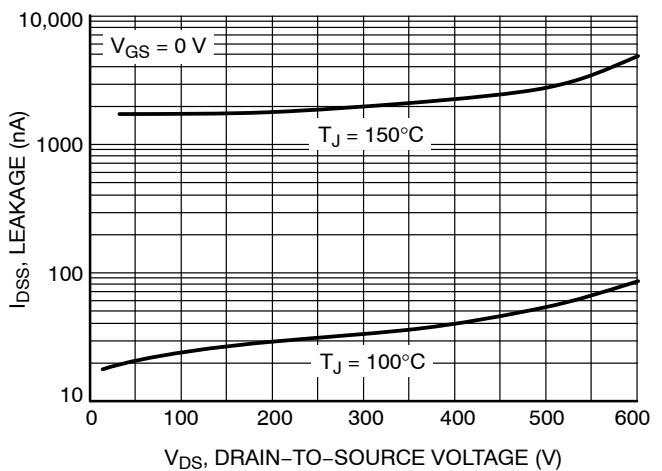

Figure 6. Drain-to-Source Leakage Current vs. Voltage

NDF06N60Z

TYPICAL CHARACTERISTICS

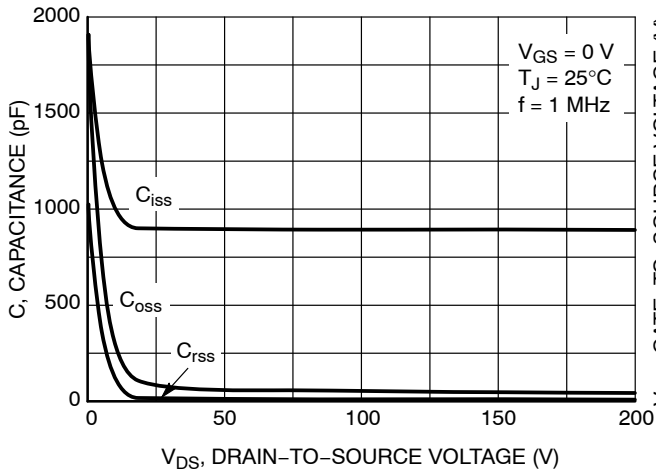

Figure 7. Capacitance Variation

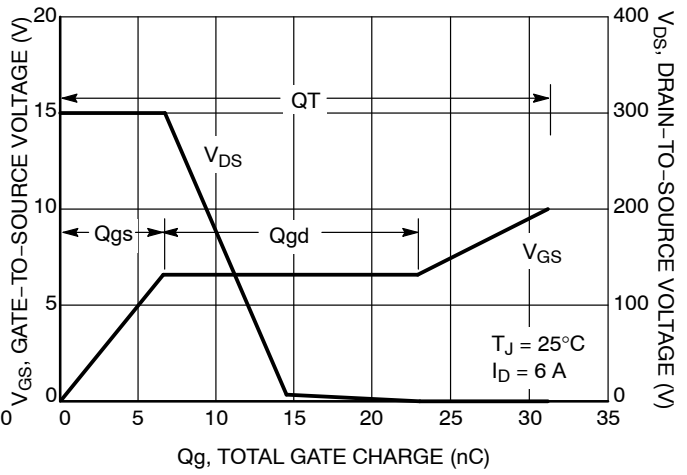

Figure 8. Gate-to-Source and Drain-to-Source Voltage vs. Total Charge

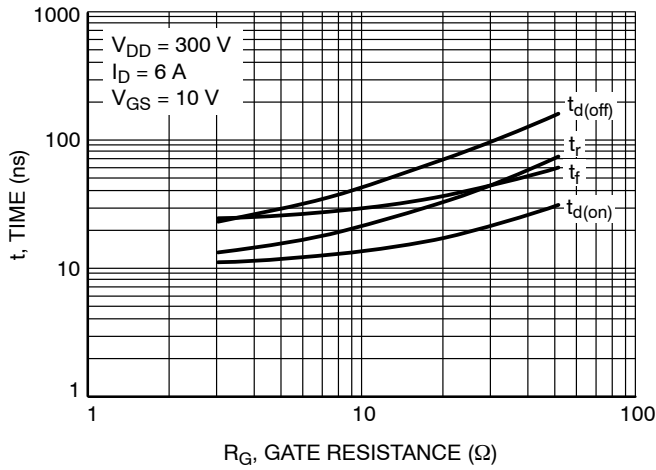

Figure 9. Resistive Switching Time Variation vs. Gate Resistance

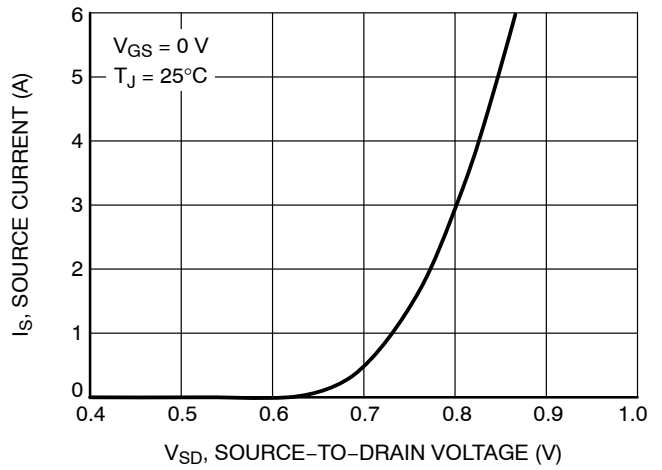

Figure 10. Diode Forward Voltage vs. Current

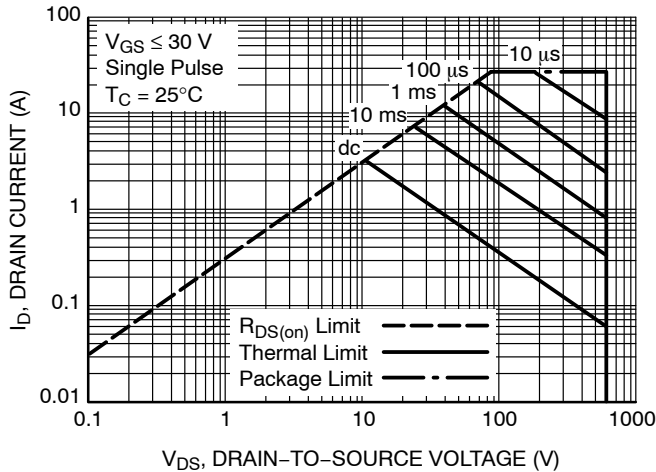

Figure 11. Maximum Rated Forward Biased Safe Operating Area for NDF06N60Z

NDF06N60Z

TYPICAL CHARACTERISTICS

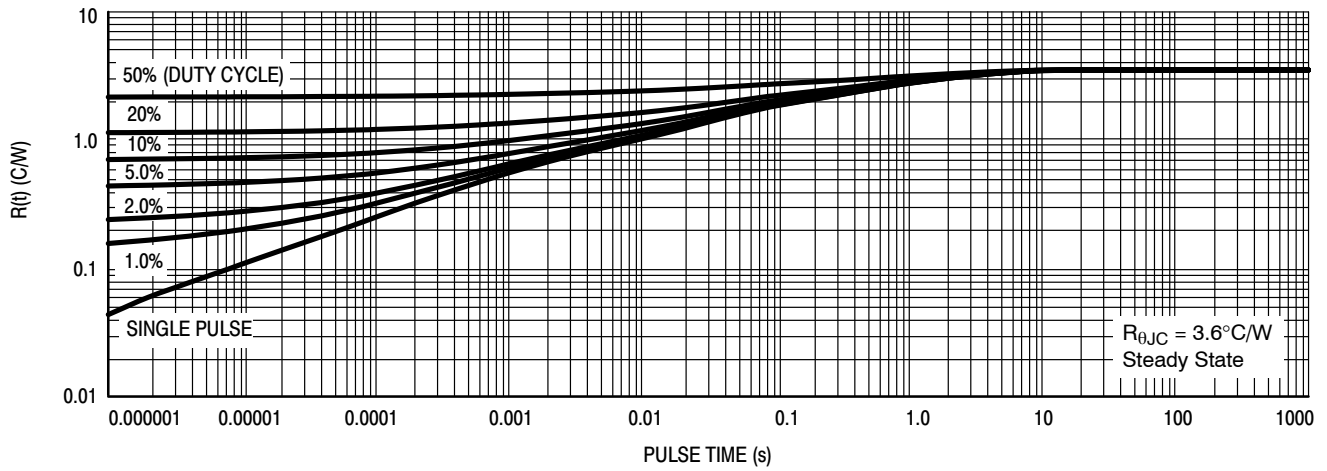

Figure 12. Thermal Impedance for NDF06N60Z

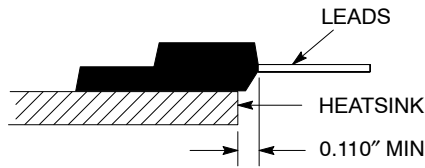

Figure 13. Mounting Position for Isolation Test

Measurement made between leads and heatsink with all leads shorted together.

*For additional mounting information, please download the ON Semiconductor Soldering and Mounting Techniques Reference Manual, SOLDERRM/D.

NDF06N60Z

ORDERING INFORMATION

Order Number	Package	Shipping†
NDF06N60ZG	TO-220FP (Pb-Free, Halogen-Free)	50 Units / Rail
NDF06N60ZH	TO-220FP (Pb-Free, Halogen-Free)	50 Units / Rail

†For information on tape and reel specifications, including part orientation and tape sizes, please refer to our Tape and Reel Packaging Specifications Brochure, BRD8011/D.

MARKING DIAGRAMS

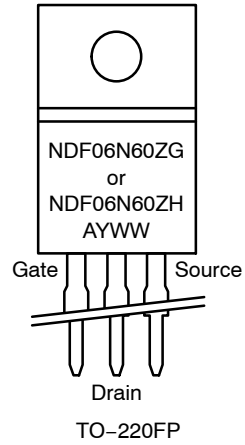

A = Location Code
Y = Year
WW = Work Week
G, H = Pb-Free, Halogen-Free Package

NDF06N60Z

PACKAGE DIMENSIONS

TO-220 FULLPAK
CASE 221D-03
ISSUE K

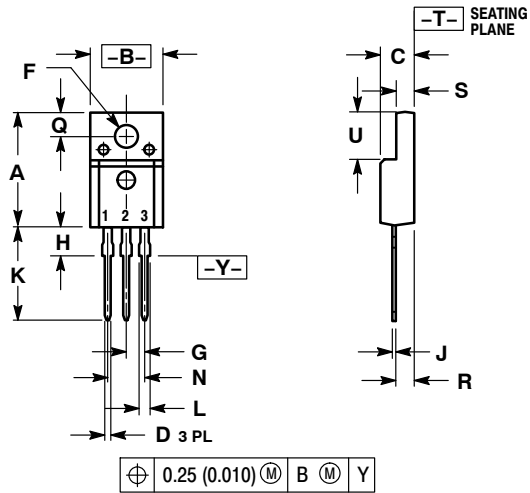

NOTES:

1. DIMENSIONING AND TOLERANCING PER ANSI Y14.5M, 1982.
2. CONTROLLING DIMENSION: INCH
3. 221D-01 THRU 221D-02 OBSOLETE, NEW STANDARD 221D-03.

DIM	INCHES		MILLIMETERS	
	MIN	MAX	MIN	MAX
A	0.617	0.635	15.67	16.12
B	0.392	0.419	9.96	10.63
C	0.177	0.193	4.50	4.90
D	0.024	0.039	0.60	1.00
F	0.116	0.129	2.95	3.28
G	0.100 BSC		2.54 BSC	
H	0.118	0.135	3.00	3.43
J	0.018	0.025	0.45	0.63
K	0.503	0.541	12.78	13.73
L	0.048	0.058	1.23	1.47
N	0.200 BSC		5.08 BSC	
Q	0.122	0.138	3.10	3.50
R	0.099	0.117	2.51	2.96
S	0.092	0.113	2.34	2.87
U	0.239	0.271	6.06	6.88

STYLE 1:

- PIN 1. GATE
2. DRAIN
3. SOURCE

NDF06N60Z

PACKAGE DIMENSIONS

TO-220 FULLPACK, 3-LEAD CASE 221AH ISSUE B

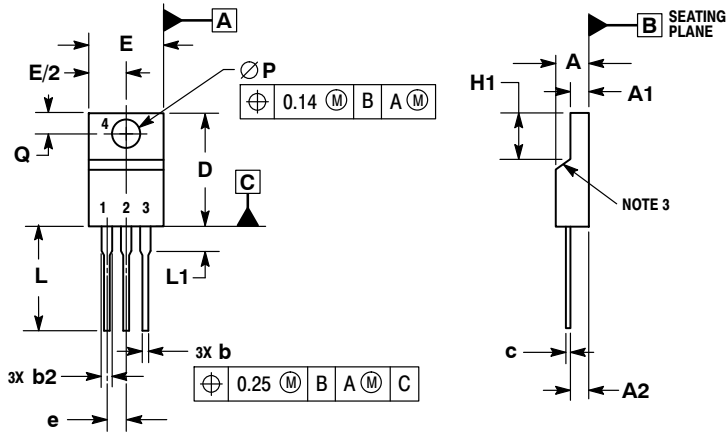

NOTES:

1. DIMENSIONING AND TOLERANCING PER ASME Y14.5M, 1994.
2. CONTROLLING DIMENSION: MILLIMETERS.
3. CONTOUR UNCONTROLLED IN THIS AREA.
4. DIMENSIONS D AND E DO NOT INCLUDE MOLD FLASH AND GATE PROTRUSIONS. MOLD FLASH AND GATE PROTRUSIONS NOT TO EXCEED 0.13 PER SIDE. THESE DIMENSIONS ARE TO BE MEASURED AT OUTERMOST EXTREME OF THE PLASTIC BODY.
5. DIMENSION b2 DOES NOT INCLUDE DAMBAR PROTRUSION. LEAD WIDTH INCLUDING PROTRUSION SHALL NOT EXCEED 2.00.

DIM	MILLIMETERS	
	MIN	MAX
A	4.30	4.70
A1	2.50	2.90
A2	2.50	2.70
b	0.54	0.84
b2	1.10	1.40
c	0.49	0.79
D	14.70	15.30
E	9.70	10.30
e	2.54 BSC	
H1	6.70	7.10
L	12.70	14.73
L1	---	2.80
P	3.00	3.40
Q	2.80	3.20

ON Semiconductor and are registered trademarks of Semiconductor Components Industries, LLC (SCILLC). SCILLC reserves the right to make changes without further notice to any products herein. SCILLC makes no warranty, representation or guarantee regarding the suitability of its products for any particular purpose, nor does SCILLC assume any liability arising out of the application or use of any product or circuit, and specifically disclaims any and all liability, including without limitation special, consequential or incidental damages. "Typical" parameters which may be provided in SCILLC data sheets and/or specifications can and do vary in different applications and actual performance may vary over time. All operating parameters, including "Typicals" must be validated for each customer application by customer's technical experts. SCILLC does not convey any license under its patent rights nor the rights of others. SCILLC products are not designed, intended, or authorized for use as components in systems intended for surgical implant into the body, or other applications intended to support or sustain life, or for any other application in which the failure of the SCILLC product could create a situation where personal injury or death may occur. Should Buyer purchase or use SCILLC products for any such unintended or unauthorized application, Buyer shall indemnify and hold SCILLC and its officers, employees, subsidiaries, affiliates, and distributors harmless against all claims, costs, damages, and expenses, and reasonable attorney fees arising out of, directly or indirectly, any claim of personal injury or death associated with such unintended or unauthorized use, even if such claim alleges that SCILLC was negligent regarding the design or manufacture of the part. SCILLC is an Equal Opportunity/Affirmative Action Employer. This literature is subject to all applicable copyright laws and is not for resale in any manner.

PUBLICATION ORDERING INFORMATION

LITERATURE FULFILLMENT:
Literature Distribution Center for ON Semiconductor
P.O. Box 5163, Denver, Colorado 80217 USA
Phone: 303-675-2175 or 800-344-3860 Toll Free USA/Canada
Fax: 303-675-2176 or 800-344-3867 Toll Free USA/Canada
Email: orderlit@onsemi.com

N. American Technical Support: 800-282-9855 Toll Free
USA/Canada
Europe, Middle East and Africa Technical Support:
Phone: 421 33 790 2910
Japan Customer Focus Center
Phone: 81-3-5817-1050

ON Semiconductor Website: www.onsemi.com

Order Literature: <http://www.onsemi.com/orderlit>

For additional information, please contact your local Sales Representative