



Micro Commercial Components



Micro Commercial Components
20736 Marilla Street Chatsworth
CA 91311
Phone: (818) 701-4933
Fax: (818) 701-4939

2SA1213-O

2SA1213-Y

Features

- Lead Free Finish/RoHS Compliant ("P" Suffix designates RoHS Compliant. See ordering information)
- Low Saturation voltage: $V_{CE(sat)}=0.5V(max.)(I_C=1.0A)$
- Small flat package
- $P_C=1.0$ to $2.0W$ (mounted on ceramic substrate)
- High Speed Switching Time : $t_{stg} = 1.0\mu s$ (typ.)
- Epoxy meets UL 94 V-0 flammability rating
- Moisture Sensitivity Level 1

Maximum Ratings

Symbol	Rating	Rating	Unit
V_{CEO}	Collector-Emitter Voltage	-50	V
V_{CBO}	Collector-Base Voltage	-50	V
V_{EBO}	Emitter-Base Voltage	-5.0	V
I_C	Collector Current	-2.0	A
I_B	Base Current	-0.4	A
P_C	Collector power dissipation	0.5 1.0*	W
T_J	Junction Temperature	150	°C
T_{STG}	Storage Temperature	-55 to +150	°C

* Mounted on ceramic substrate (250mm² x 0.8t)

Electrical Characteristics @ 25°C Unless Otherwise Specified

Symbol	Parameter	Min	Typ	Max	Units
OFF CHARACTERISTICS					
$V_{(BR)CEO}$	Collector-Emitter Breakdown Voltage ($I_C=10mA_{dc}, I_B=0$)	-50	---	---	Vdc
I_{CBO}	Collector-Base Cutoff Current ($V_{CB}=50V_{dc}, I_E=0$)	---	---	-0.1	μA_{dc}
I_{EBO}	Emitter-Base Cutoff Current ($V_{EB}=5.0V_{dc}, I_C=0$)	---	---	-0.1	μA_{dc}

ON CHARACTERISTIC

$h_{FE(1)}$	DC Current Gain ($I_C=0.5A_{dc}, V_{CE}=2.0V_{dc}$)	70	---	240	---
$h_{FE(2)}$	DC Current Gain * ($I_C=2.0A_{dc}, V_{CE}=2.0V_{dc}$)	20	---	---	---
$V_{CE(sat)}$	Collector-Emitter Saturation Voltage ($I_C=1.0A_{dc}, I_B=0.05A_{dc}$)	---	---	-0.5	Vdc
$V_{BE(sat)}$	Base-Emitter Saturation Voltage ($I_C=1.0A_{dc}, I_B=0.05A_{dc}$)	---	---	-1.2	Vdc
f_T	Transition Frequency ($V_{CE}=2.0V_{dc}, I_C=0.5A_{dc}$)	100	120	---	MHz
C_{ob}	Collector output capacitance ($V_{CB}=10V_{dc}, f=1.0MHz$)	---	40	---	pF

CLASSIFICATION OF $h_{FE(1)}$

Rank	O	Y
Range	70-140	120-240
Marking	NO	NY

PNP Silicon Epitaxial Transistors

SOT-89

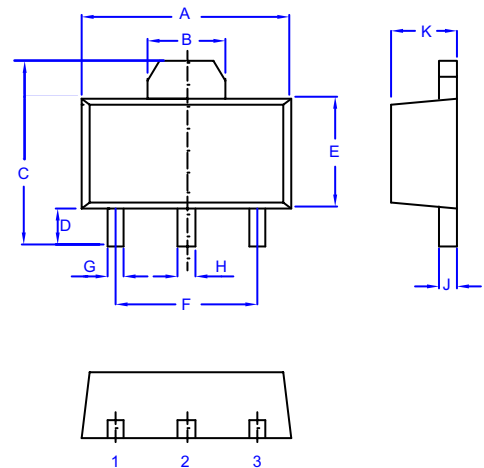

1. Base
2. Collector
3. Emitter

DIM	DIMENSIONS				NOTES
	INCHES		MM		
	MIN	MAX	MIN	MAX	
A	.173	.181	4.39	4.60	
B	.063	.071	1.60	1.80	
C	.154	.165	3.91	4.19	
D	.031	.039	0.80	1.00	
E	.092	.100	2.34	2.54	
F	.118	----	3.00	----	TYP
G	.013	.019	0.33	0.48	
H	.015	.021	0.38	0.53	
J	.015	.016	0.38	0.41	
K	.055	.063	1.40	1.60	

Typical Characteristic

2SA1213

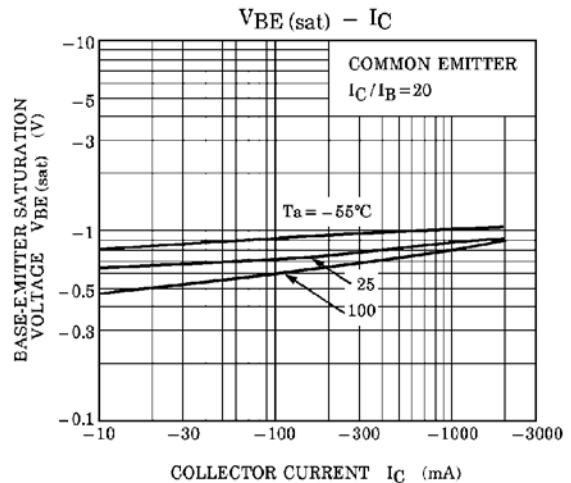
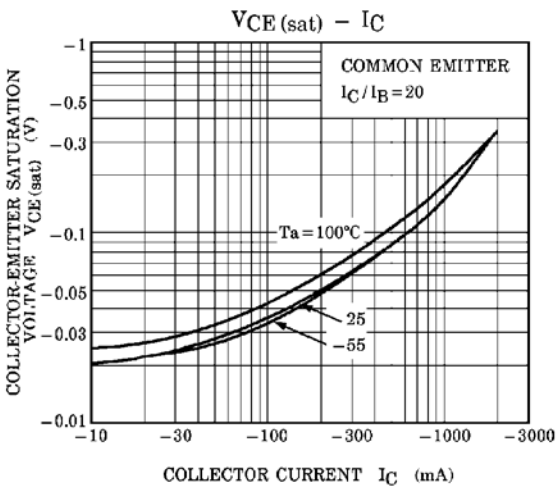
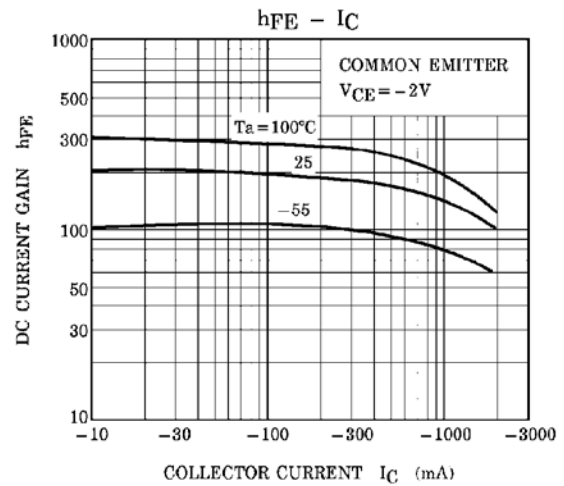
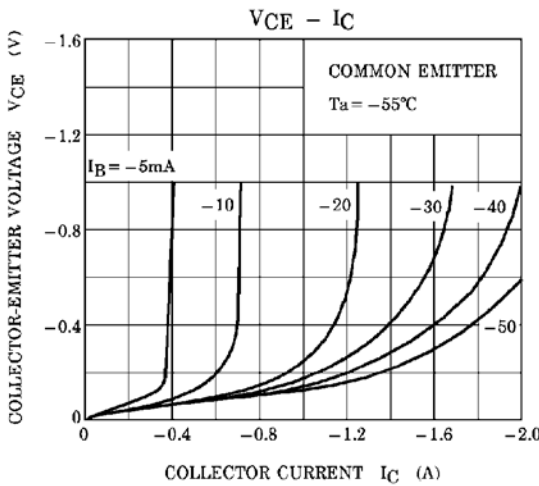
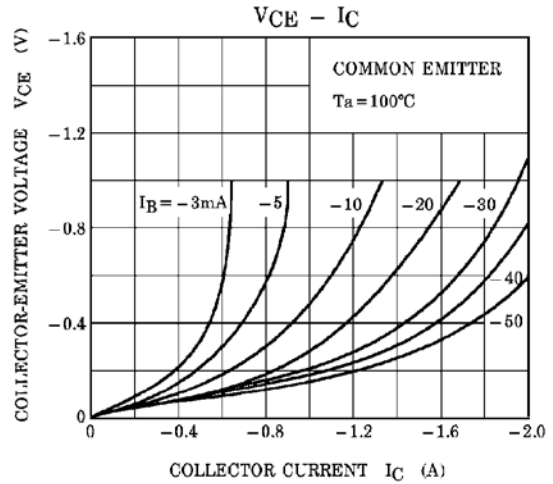
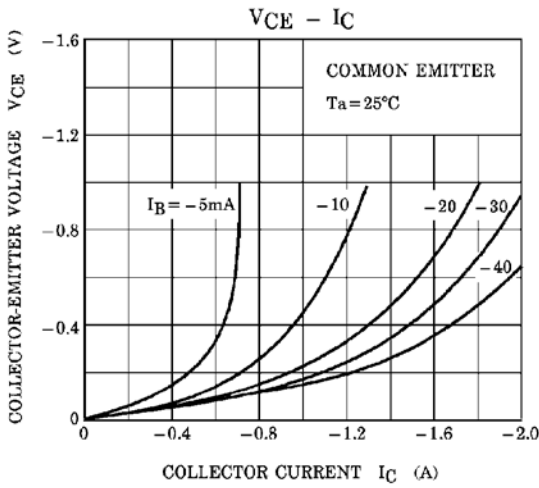

Typical Characteristics

2SA1213

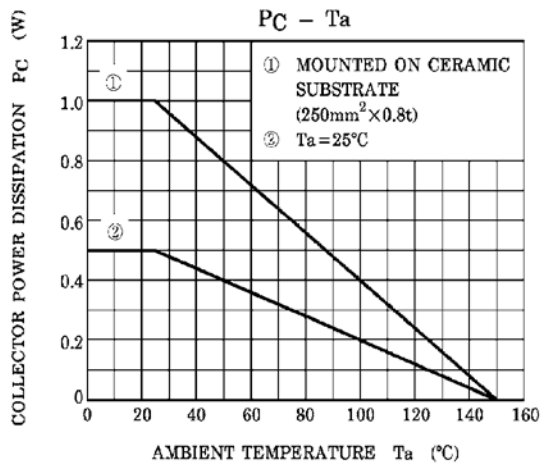
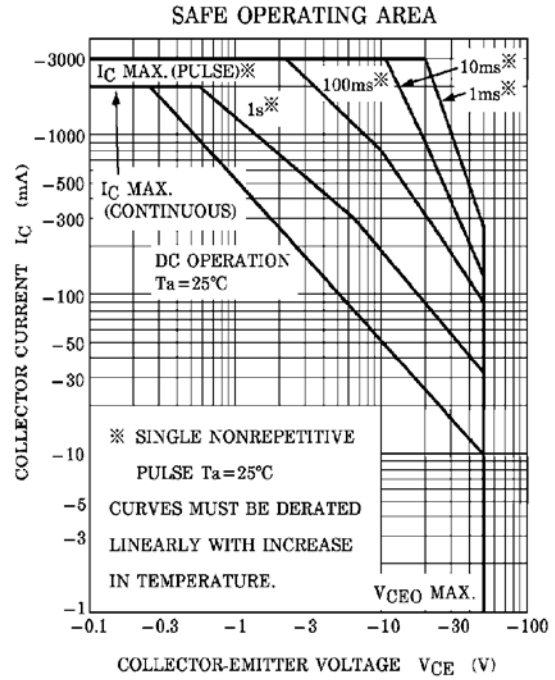
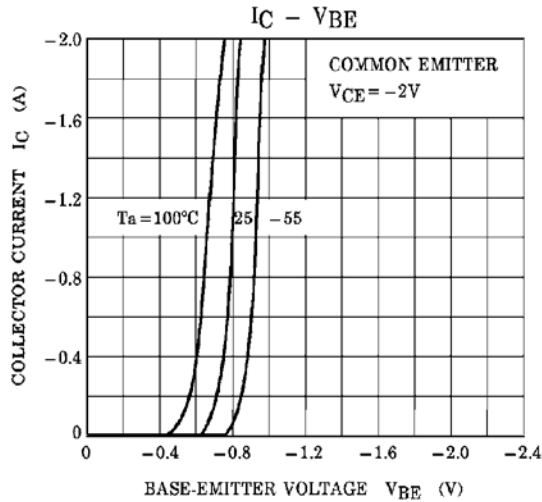



Micro Commercial Components

Ordering Information :

Device	Packing
Part Number-TP	Tape&Reel; 1Kpcs/Reel

*****IMPORTANT NOTICE*****

Micro Commercial Components Corp. reserves the right to make changes without further notice to any product herein to make corrections, modifications, enhancements, improvements, or other changes. **Micro Commercial Components Corp.** does not assume any liability arising out of the application or use of any product described herein; neither does it convey any license under its patent rights, nor the rights of others. The user of products in such applications shall assume all risks of such use and will agree to hold **Micro Commercial Components Corp.** and all the companies whose products are represented on our website, harmless against all damages.

*****LIFE SUPPORT*****

MCC's products are not authorized for use as critical components in life support devices or systems without the express written approval of Micro Commercial Components Corporation.

*****CUSTOMER AWARENESS*****

Counterfeiting of semiconductor parts is a growing problem in the industry. Micro Commercial Components (MCC) is taking strong measures to protect ourselves and our customers from the proliferation of counterfeit parts. MCC strongly encourages customers to purchase MCC parts either directly from MCC or from Authorized MCC Distributors who are listed by country on our web page cited below. Products customers buy either from MCC directly or from Authorized MCC Distributors are genuine parts, have full traceability, meet MCC's quality standards for handling and storage. **MCC will not provide any warranty coverage or other assistance for parts bought from Unauthorized Sources.** MCC is committed to combat this global problem and encourage our customers to do their part in stopping this practice by buying direct or from authorized distributors.