



DTD123Y

NPN SILICON TRANSISTOR

DIGITAL TRANSISTORS (BUILT-IN RESISTORS)

■ FEATURES

- * Built-in bias resistors that implies easy ON/OFF applications.
- * The bias resistors are thin-film resistors with complete isolation to allow negative input.

■ EQUIVALENT CIRCUIT

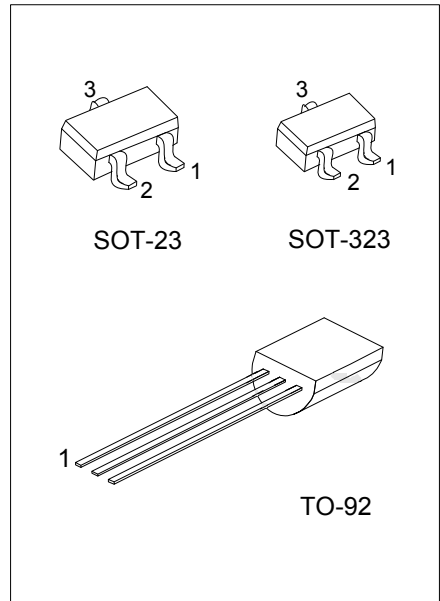
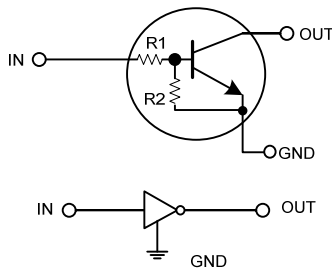

■ ORDERING INFORMATION

Ordering Number		Package	Pin Assignment			Packing
Lead Free	Halogen Free		1	2	3	
DTD123YL-AE3-R	DTD123YG-AE3-R	SOT-23	G	I	O	Tape Reel
DTD123YL-AL3-R	DTD123YG-AE3-R	SOT-323	G	I	O	Tape Reel
DTD123YL-T92-B	DTD123YG-T92-B	TO-92	G	O	I	Tape Box
DTD123YL-T92-K	DTD123YG-T92-K	TO-92	G	O	I	Bulk
DTD123YL-T92-R	DTD123YG-T92-R	TO-92	G	O	I	Tape Reel

Note: G: GND I: Input O: Output

<p>DTD123YL-AE3-R</p> <p>(1) Packing Type (2) Package Type (3) Lead Free</p>	<p>(1) B: Tape Box, K: Bulk, R: Tape Reel (2) AE3: SOT-23, AL3: SOT-323, T92: TO-92 (3) G: Halogen Free, L: Lead Free</p>
--	---

■ MARKING

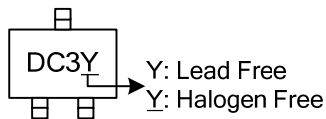

For SOT-23/SOT-323

■ ABSOLUTE MAXIMUM RATING ($T_A=25^{\circ}\text{C}$)

PARAMETER		SYMBOL	RATINGS	UNIT
Supply voltage		V_{CC}	50	V
Input voltage		V_{IN}	-5 ~ +12	V
Output current		I_C	500	mA
Power dissipation	SOT-23/SOT-323	P_D	200	mW
	TO-92		625	mW
Junction Temperature		T_J	+150	$^{\circ}\text{C}$
Storage Temperature		T_{STG}	-55 ~ +150	$^{\circ}\text{C}$

Note Absolute maximum ratings are those values beyond which the device could be permanently damaged. Absolute maximum ratings are stress ratings only and functional device operation is not implied.

■ ELECTRICAL CHARACTERISTICS ($T_A=25^{\circ}\text{C}$)

PARAMETER	SYMBOL	TEST CONDITIONS	MIN	TYP	MAX	UNIT
Input Voltage	$V_{IN(OFF)}$	$V_{CC}=5V, I_{OUT}=100\mu\text{A}$			0.3	V
	$V_{IN(ON)}$	$V_{OUT}=0.3V, I_{OUT}=20\text{mA}$	2			
Output Voltage	$V_{OUT(ON)}$	$I_O/I_I=50\text{mA}/2.5\text{mA}$		0.1	0.3	V
Input Current	I_{IN}	$V_{IN}=5V$			3.6	mA
Output Current	$I_{O(OFF)}$	$V_{CC}=50V, V_{IN}=0V$			0.5	μA
DC Current Gain	h_{FE}	$V_{OUT}=5V, I_{OUT}=50\text{mA}$	56			
Input Resistance	R_1		1.54	2.2	2.86	K Ω
Resistance Ratio	R_2/R_1		3.6	4.5	5.5	
Transition Frequency	f_T	$V_{CE}=10V, I_E=-50\text{mA}, f=100\text{MHz}$ (Note)		200		MHz

Note: Transition frequency of the device

■ TYPICAL CHARACTERISTICS

Fig.1 Input Voltage vs. Output Current (ON Characteristics)

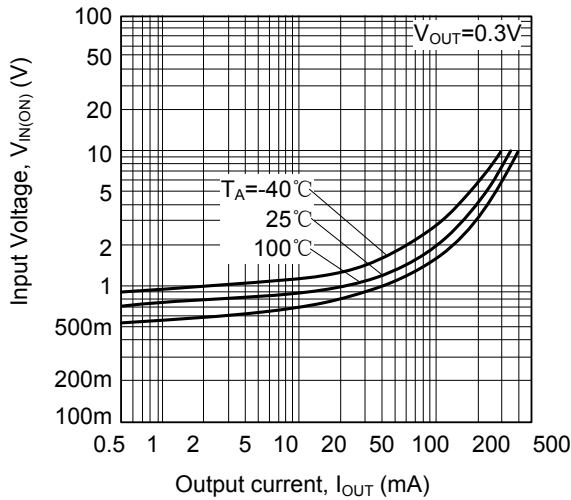

Fig.2 Output Current vs. Input Voltage (OFF Characteristics)

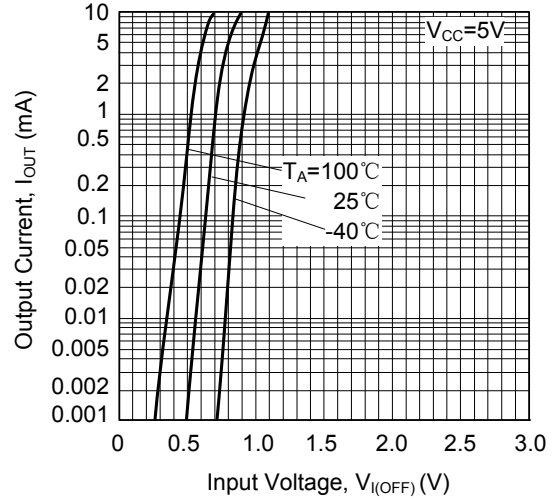

Fig.3 DC Current Gain vs. Output Current

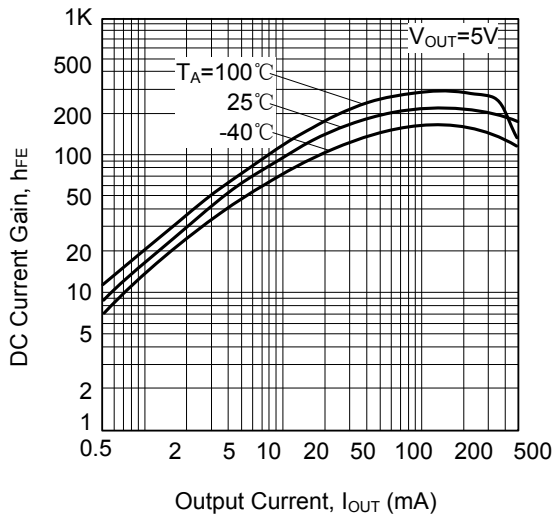
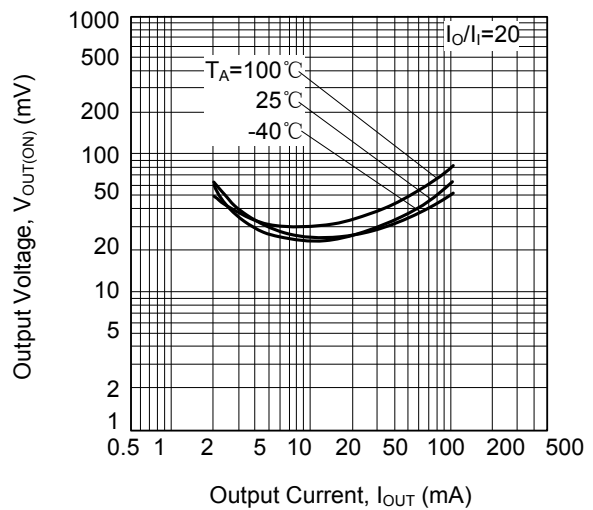

Fig.4 Output Voltage vs. Output Current



UTC assumes no responsibility for equipment failures that result from using products at values that exceed, even momentarily, rated values (such as maximum ratings, operating condition ranges, or other parameters) listed in products specifications of any and all UTC products described or contained herein. UTC products are not designed for use in life support appliances, devices or systems where malfunction of these products can be reasonably expected to result in personal injury. Reproduction in whole or in part is prohibited without the prior written consent of the copyright owner. The information presented in this document does not form part of any quotation or contract, is believed to be accurate and reliable and may be changed without notice.