



DTD143E

NPN SILICON TRANSISTOR

DIGITAL TRANSISTORS (BUILT-IN RESISTORS)

■ FEATURES

- * Built-in bias resistors that implies easy ON/OFF applications.
- * The bias resistors are thin-film resistors with complete isolation to allow positive input.

■ EQUIVALENT CIRCUIT

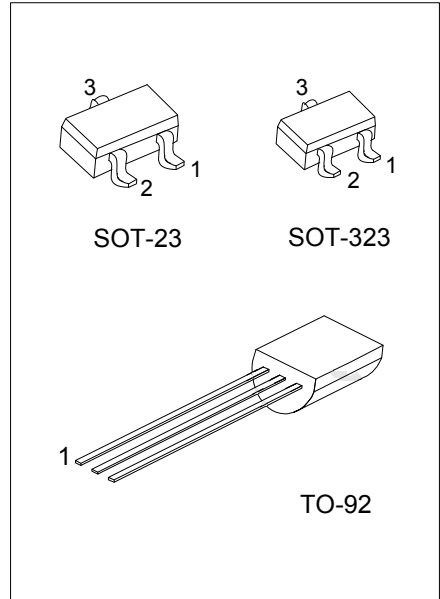
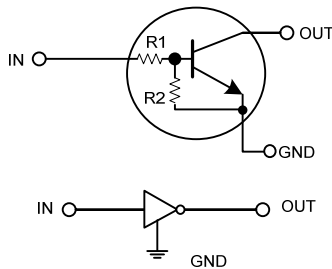

■ ORDERING INFORMATION

Order Number		Package	Pin Assignment			Packing
Lead Free	Halogen Free		1	2	3	
DTD143EL-AE3-R	DTD143EG-AE3-R	SOT-23	G	I	O	Tape Reel
DTD143EL-AL3-R	DTD143EG-AE3-R	SOT-323	G	I	O	Tape Reel
DTD143EL-T92-B	DTD143EG-T92-B	TO-92	G	O	I	Tape Box
DTD143EL-T92-K	DTD143EG-T92-K	TO-92	G	O	I	Bulk
DTD143EL-T92-R	DTD143EG-T92-R	TO-92	G	O	I	Tape Reel

<p>DTD143EL-AE3-R</p>	<p>(1) B: Tape Box, K: Bulk, R: Tape Reel</p> <p>(2) AE3: SOT-23, AL3: SOT-323, T92:TO-92</p> <p>(3) L: Lead Free , G: Halogen Free</p>
-----------------------	---

■ MARKING(FOR SOT-23/SOT-323 PACKAGE)

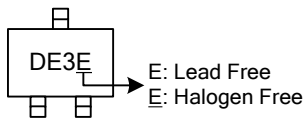

■ ABSOLUTE MAXIMUM RATINGS (T_A=25°C)

PARAMETER		SYMBOL	RATINGS	UNIT
Supply Voltage		V _{CC}	50	V
Input Voltage		V _{IN}	-10 ~ +30	V
Output Current		I _{OUT}	500	mA
Power Dissipation	SOT-23/SOT-323	P _D	200	mW
	TO-92		625	mW
Junction Temperature		T _J	+150	°C
Storage Temperature		T _{STG}	-55 ~ +150	°C

Note Absolute maximum ratings are those values beyond which the device could be permanently damaged.

Absolute maximum ratings are stress ratings only and functional device operation is not implied.

■ ELECTRICAL SPECIFICATIONS (T_A=25°C)

PARAMETER	SYMBOL	TEST CONDITIONS	MIN	TYP	MAX	UNIT
Input Voltage	V _{IN(OFF)}	V _{CC} = 5V, I _{OUT} = 100μA			0.5	V
	V _{IN(ON)}	V _{OUT} = 0.3V, I _{OUT} = 20mA	3			
Output Voltage	V _{OUT(ON)}	I _{OUT} /I _{IN} = 50mA/2.5mA		0.1	0.3	V
Input Current	I _{IN}	V _{IN} = 5V			1.8	mA
Output Current	I _{OUT(OFF)}	V _{CC} = 50V, V _{IN} = 0V			0.5	μA
DC Current Gain	h _{FE}	V _{OUT} = 5V, I _{OUT} = 50mA	47			
Input Resistance	R ₁		3.29	4.7	6.11	KΩ
Resistance Ratio	R ₂ /R ₁		0.8	1	1.2	
Transition Frequency	f _T	V _{CE} = 10V, I _E = -50mA, f = 100MHz(Note)		200		MHz

Note: Transition frequency of the device

TYPICAL CHARACTERISTIC

Input Voltage vs. Output Current
(ON Characteristics)

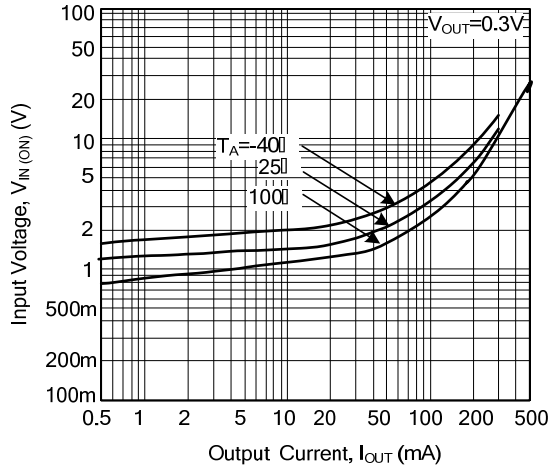

Output Current vs. Input Voltage
(OFF Characteristics)

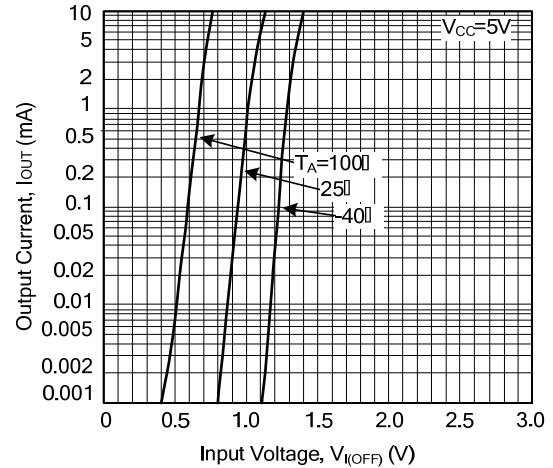

DC Current Gain vs. Output Current

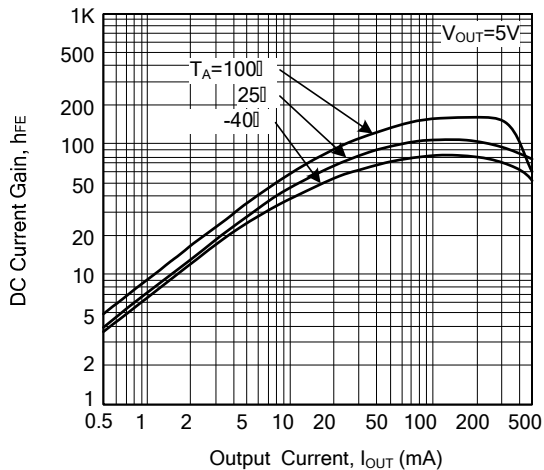

Output Voltage vs. Output Current

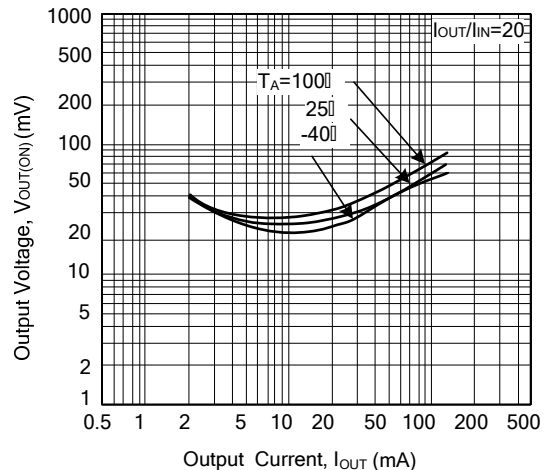

UTC assumes no responsibility for equipment failures that result from using products at values that exceed, even momentarily, rated values (such as maximum ratings, operating condition ranges, or other parameters) listed in products specifications of any and all UTC products described or contained herein. UTC products are not designed for use in life support appliances, devices or systems where malfunction of these products can be reasonably expected to result in personal injury. Reproduction in whole or in part is prohibited without the prior written consent of the copyright owner. The information presented in this document does not form part of any quotation or contract, is believed to be accurate and reliable and may be changed without notice.