



DTD114E

NPN SILICON TRANSISTOR

NPN DIGITAL TRANSISTOR (BUILT-IN BIAS RESISTORS)

FEATURES

- * Built-in bias resistors that implies easy ON/OFF applications.
- * The bias resistors are thin-film resistors with complete isolation to allow negative input.

EQUIVALENT CIRCUIT

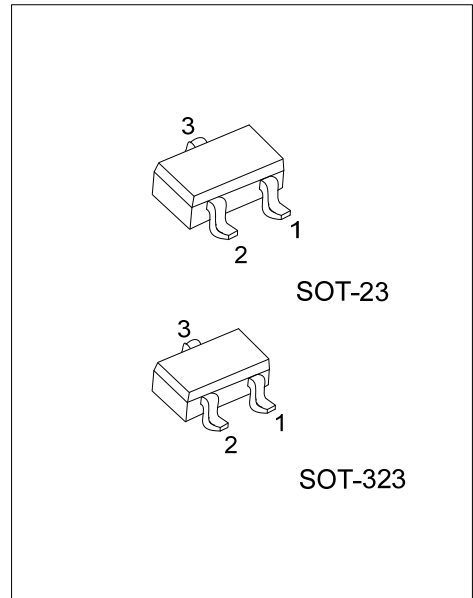
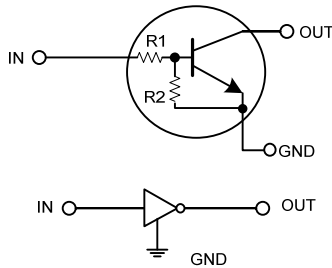

ORDERING INFORMATION

Ordering Number		Package	Pin Assignment			Packing
Lead Free	Halogen Free		1	2	3	
DTD114EL-AE3-R	DTD114EG-AE3-R	SOT-23	G	I	O	Tape Reel
DTD114EL-AL3-R	DTD114EG-AL3-R	SOT-323	G	I	O	Tape Reel

<p>DTD114EL-AE3-R</p> <p>(1)Packing Type (2)Package Type (3)Lead Free</p>	<p>(1) R: Tape Reel (2) AE3: SOT-23, AL3: SOT-323 (3) G: Halogen Free, L: Lead Free</p>
---	---

MARKING

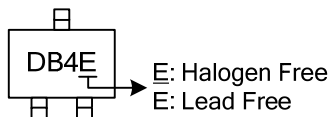

■ ABSOLUTE MAXIMUM RATINGS (Ta=25°C)

PARAMETER	SYMBOL	RATING	UNIT
Supply Voltage	V _{CC}	50	V
Input Voltage	V _{IN}	-10~+40	V
Output Current	I _{OUT}	500	mA
Power Dissipation	P _D	200	mW
Junction Temperature	T _J	150	°C
Storage Temperature	T _{STG}	-40 ~ +150	°C

Note Absolute maximum ratings are those values beyond which the device could be permanently damaged.
 Absolute maximum ratings are stress ratings only and functional device operation is not implied.

■ ELECTRICAL SPECIFICATIONS (Ta=25°C, unless others specified)

PARAMETER	SYMBOL	TEST CONDITIONS	MIN	TYP	MAX	UNIT
Input Voltage	V _{IN(OFF)}	V _{CC} =5V, I _{OUT} =100μA			0.5	V
	V _{IN(ON)}	V _{OUT} =0.3V, I _{OUT} =10mA	3			
Output Voltage	V _{OUT(ON)}	I _{OUT} /I _{IN} =50mA/2.5mA		0.1	0.3	V
Input Current	I _{IN}	V _{IN} =5V			0.88	mA
Output Current	I _{OUT(OFF)}	V _{CC} =50V, V _{IN} =0V			0.5	μA
DC Current Gain	h _{FE}	V _{OUT} =5V, I _{OUT} =50mA	56			
Input Resistance	R ₁		7	10	13	kΩ
Resistance Ratio	R ₂ /R ₁		0.8	1	1.2	
Transition Frequency	f _T	V _{CE} =10V, I _E =-50mA, f=100MHz		200		MHz

*Transition frequency of the device

TYPICAL CHARACTERISTICS

Input Voltage vs. Output Current
(ON Characteristics)

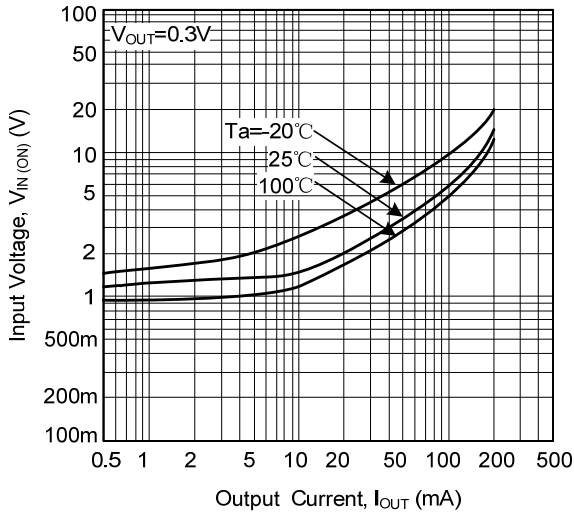

Output Current vs. Input Voltage
(OFF Characteristics)

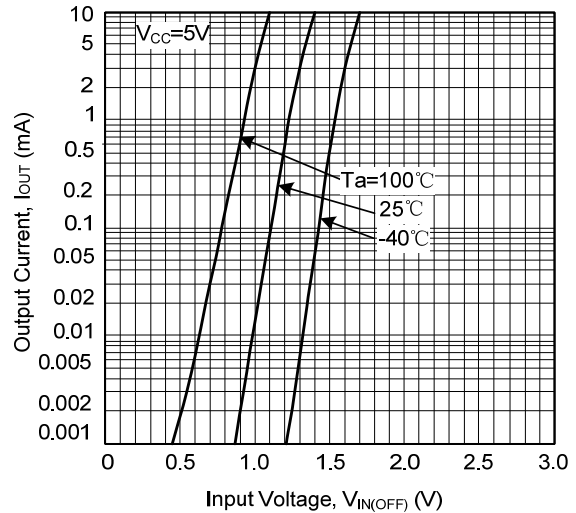

DC Current Gain vs. Output Current

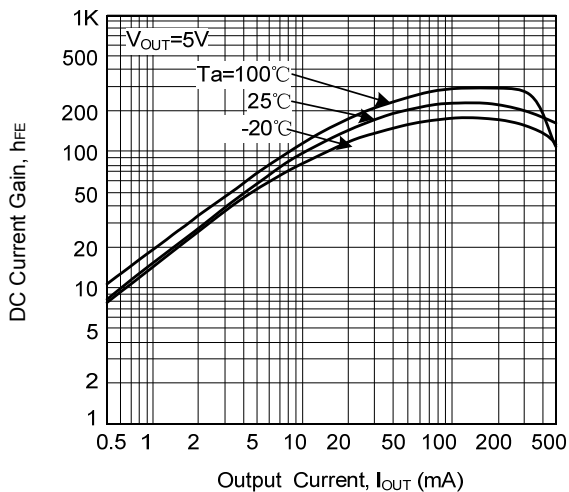

Output Voltage vs. Output Current

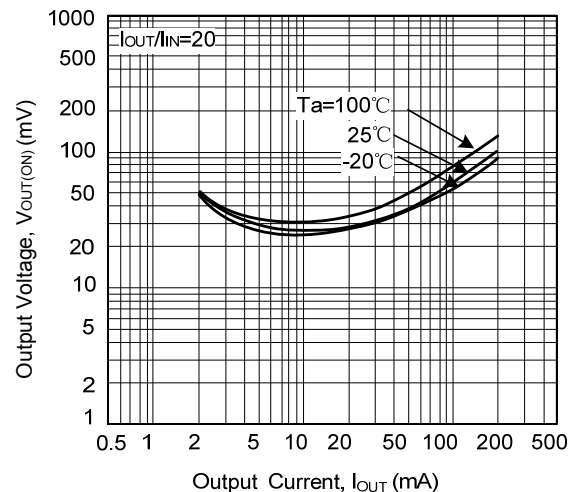

UTC assumes no responsibility for equipment failures that result from using products at values that exceed, even momentarily, rated values (such as maximum ratings, operating condition ranges, or other parameters) listed in products specifications of any and all UTC products described or contained herein. UTC products are not designed for use in life support appliances, devices or systems where malfunction of these products can be reasonably expected to result in personal injury. Reproduction in whole or in part is prohibited without the prior written consent of the copyright owner. The information presented in this document does not form part of any quotation or contract, is believed to be accurate and reliable and may be changed without notice.