

SILICON NPN TRANSISTOR

BFY50

- $V_{(BR)CEO} = 35V$ (Min).
- Hermetic TO-39 Metal Package.
- Ideally Suited General Purpose Amplifier Applications
- Screening Options Available

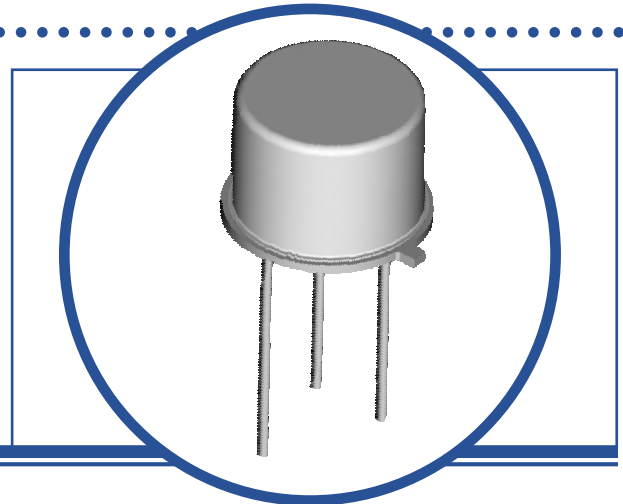

ABSOLUTE MAXIMUM RATINGS ($T_A = 25^\circ C$ unless otherwise stated)

V_{CBO}	Collector – Base Voltage	80V
V_{CEO}	Collector – Emitter Voltage	35V
V_{EBO}	Emitter – Base Voltage	6V
I_C	Continuous Collector Current	1.0A
P_D	Total Power Dissipation at $T_A = 25^\circ C$	0.8W
	Derate Above $25^\circ C$	4.57mW/ $^\circ C$
P_D	Total Power Dissipation at $T_C = 25^\circ C$	5W
	Derate Above $25^\circ C$	28.6mW/ $^\circ C$
T_J	Junction Temperature Range	-65 to +200 $^\circ C$
T_{stg}	Storage Temperature Range	-65 to +200 $^\circ C$

THERMAL PROPERTIES

Symbols	Parameters	Max.	Units
$R_{\theta JA}$	Thermal Resistance, Junction To Ambient	218.75	$^\circ C/W$
$R_{\theta JC}$	Thermal Resistance, Junction To Case	35	$^\circ C/W$

Semelab Limited reserves the right to change test conditions, parameter limits and package dimensions without notice. Information furnished by Semelab is believed to be both accurate and reliable at the time of going to press. However Semelab assumes no responsibility for any errors or omissions discovered in its use. Semelab encourages customers to verify that datasheets are current before placing orders.

SILICON NPN TRANSISTOR BFY50

ELECTRICAL CHARACTERISTICS (T_A = 25°C unless otherwise stated)

Symbols	Parameters	Test Conditions	Min.	Typ	Max.	Units
V _{(BR)CEO} ⁽¹⁾	Collector-Emitter Breakdown Voltage	I _C = 10mA I _B = 0	35			V
V _{(BR)CBO}	Collector-Base Breakdown Voltage	I _C = 10μA I _E = 0	80			
V _{(BR)EBO}	Emitter-Base Breakdown Voltage	I _E = 10μA I _C = 0	6			
I _{CBO}	Collector Cut-Off Current	V _{CB} = 60V I _E = 0			50	nA
		T _A = 100°C			2.5	μA
I _{EBO}	Emitter Cut-Off Current	V _{EB} = 5V I _C = 0			50	nA
		T _A = 100°C			2.8	μA
h _{FE} ⁽¹⁾	Forward-current transfer ratio	I _C = 10mA V _{CE} = 6V	20			
		I _C = 150mA V _{CE} = 6V	30			
		I _C = 1.0A V _{CE} = 6V	15			
V _{CE(sat)} ⁽¹⁾	Collector-Emitter Saturation Voltage	I _C = 150mA I _B = 15mA			0.2	V
		I _C = 1.0A I _B = 100mA			1.0	
V _{BE(sat)} ⁽¹⁾	Base-Emitter Saturation Voltage	I _C = 1.0A I _B = 100mA			2	

DYNAMIC CHARACTERISTICS

h _{fe}	Small-Signal Current Gain	I _C = 1.0mA V _{CE} = 6V f = 1.0KHz	10			
f _T	Transition Frequency	I _C = 50mA V _{CE} = 6V f = 20MHz	60			MHz
C _{obo}	Output Capacitance	V _{CB} = 12V I _E = 0 f = 1.0MHz			12	pF

Notes

(1) Pulse Width ≤ 380us, δ ≤ 2%

SILICON NPN TRANSISTOR BFY50

MECHANICAL DATA

Dimensions in mm (inches)

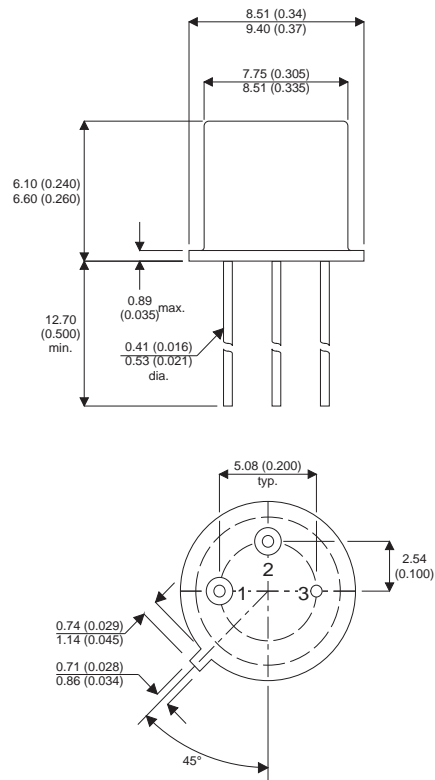

TO-39 (TO-205AD) METAL PACKAGE Underside View

Pin 1 - Emitter

Pin 2 - Base

Pin 3 - Collector