

P-channel 4V (G-S) MOSFET

FEATURES

- Low On Resistance
- Ultra High Speed Switching
- 4V Driving
- EU RoHS Compliant, Pb Free

APPLICATION

Switching

PRODUCT NAME

PRODUCT NAME	PACKAGE	ORDER UNIT
XP202A0003PR-G	SOT-89	1,000/Reel

The "-G" suffix indicates that the products are Halogen and Antimony free as well as being fully RoHS compliant.

The high-melting solder paste (lead-containing) is used as attachment.

ABSOLUTE MAXIMUM RATINGS

PARAMETER	SYMBOL	RATINGS	UNITS
Drain-Source Voltage	V_{DSS}	-30	V
Gate-Source Voltage	V_{GSS}	± 20	V
Drain Current (DC)	I_D	-5	A
Drain Current(Pulse) ^{(*)1}	I_{DP}	-20	A
Channel Power Dissipation ^{(*)2}	P_d	1.5	W
Channel Temperature	T_{ch}	+150	
Storage Temperature	T_{stg}	- 55 ~ +150	

(*)1 PW 10 μ s, duty cycle 1%

(*)2 Ceramic Board (250mm² × 0.8mm) Mounting

PIN CONFIGURATION

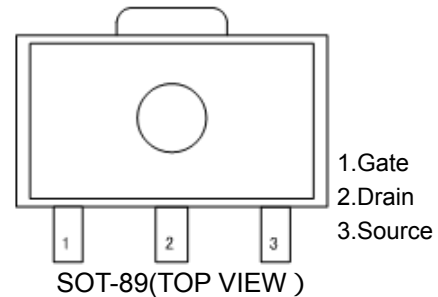

ELECTRICAL CHARACTERISTICS

PARAMETER	SYMBOL	TEST CONDITIONS	LIMITS			UNITS
			MIN.	TYP.	MAX.	
Drain-Source Breakdown Voltage	$V_{(BR)DSS}$	$I_D = -1mA, V_{GS} = 0V$	-30	-	-	V
Drain-Source Cut-Off Current	I_{DSS}	$V_{DS} = -30V, V_{GS} = 0V$	-	-	-1	μA
Gate-Source Leakage Current	I_{GSS}	$V_{GS} = \pm 16V, V_{DS} = 0V$	-	-	± 10	μA
Gate-Source Cut-Off Voltage	$V_{GS(off)}$	$V_{DS} = -10V, I_D = -1mA$	-1.2	-	-2.6	V
Forward Transfer Admittance	$ y_{fs} $	$V_{DS} = -10V, I_D = -3A$	2.8	8.0	-	S
Drain-Source ON Resistance	$R_{DS(ON)1}$	$I_D = -3A, V_{GS} = -10V$	-	47	59	m
	$R_{DS(ON)2}$	$I_D = -1.5A, V_{GS} = -4.5V$	-	70	100	m
	$R_{DS(ON)3}$	$I_D = -1.5A, V_{GS} = -4V$	-	80	113	m
Input Capacity	C_{iss}	$V_{DS} = -10V, f = 1MHz$	-	450	-	pF
Output Capacity	C_{oss}	$V_{DS} = -10V, f = 1MHz$	-	110	-	pF
Feedback capacity	C_{rss}	$V_{DS} = -10V, f = 1MHz$	-	80	-	pF
Turn on Delay time	$t_d(on)$		-	7	-	ns
Rise Time	t_r		-	8	-	ns
Turn off Delay Time	$t_d(off)$		-	31	-	ns
Fall Time	t_f		-	6	-	ns
All Gate Charge Amount	Q_g		-	10	-	nC
Gate Source Charge Amount	Q_{gs}		-	1.5	-	nC
Gate Drain Charge Amount	Q_{gd}		-	2.5	-	nC
Diode Forward Voltage	V_{SD}	$I_S = -5A, V_{GS} = 0V$	-	-0.9	-1.2	V

SWITCHING-TIME TEST CIRCUIT

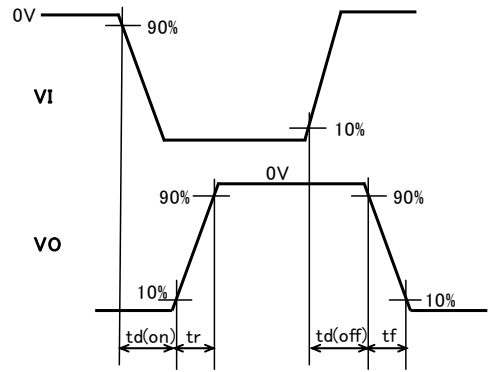
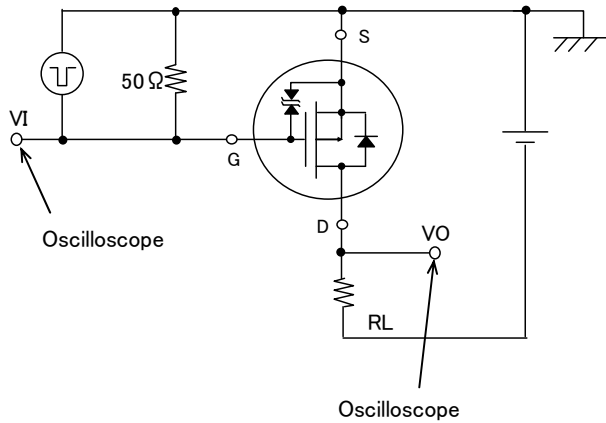

EQUIVALENT CIRCUIT

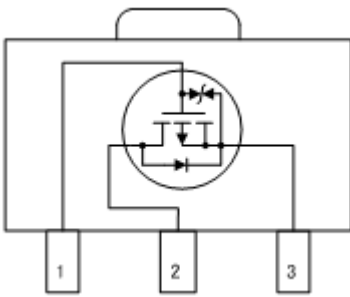

PACKAGING INFORMATION SOT-89

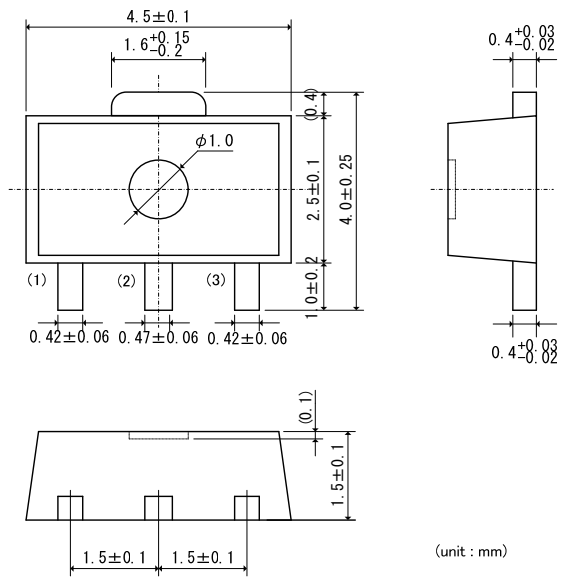

(unit : mm)

MARKING RULE

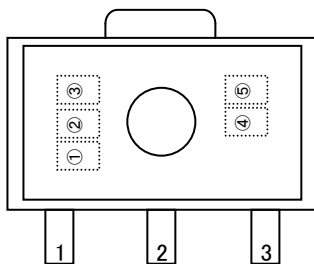

represents product series

MARK	PRODUCT SERIES
6	XP202*****-G

represents product group and number

MARK		PRODUCT GROUP	PRODUCT NUMBER	PRODUCT SERIES
A	D	00	03	XP202A0003**-G

, represents production lot number

0 to 9, 0A to 0Z, 11 to 9Z, A1 to A9, AA to Z9, ZA to ZZ repeated (G, I, J, O, Q, W excluded)

*No character inversion used

TYPICAL PERFORMANCE CHARACTERISTICS

(1) Drain Current vs. Drain-Source Voltage

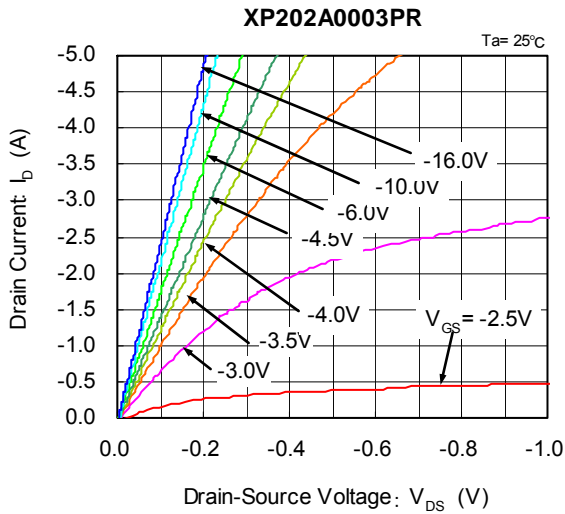

(2) Drain Current vs. Drain-Source Voltage

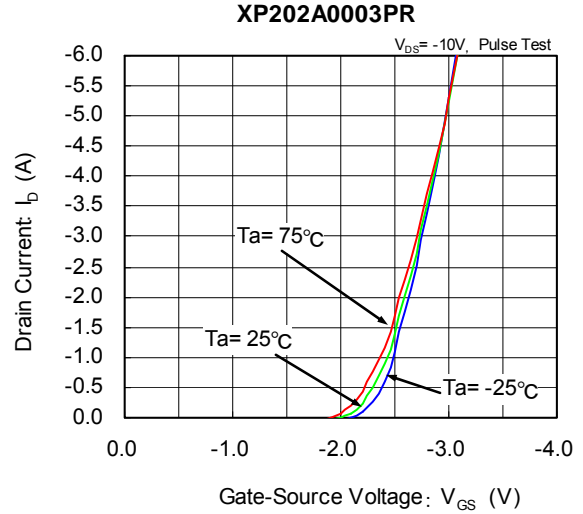

(3) Drain-Source On-State Resistance vs. Gate-Source Voltage

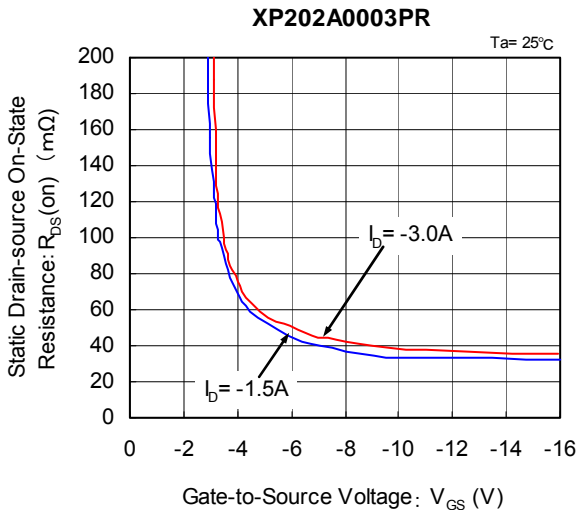

(4) Drain-Source On-State Resistance vs. Ambient Temperature

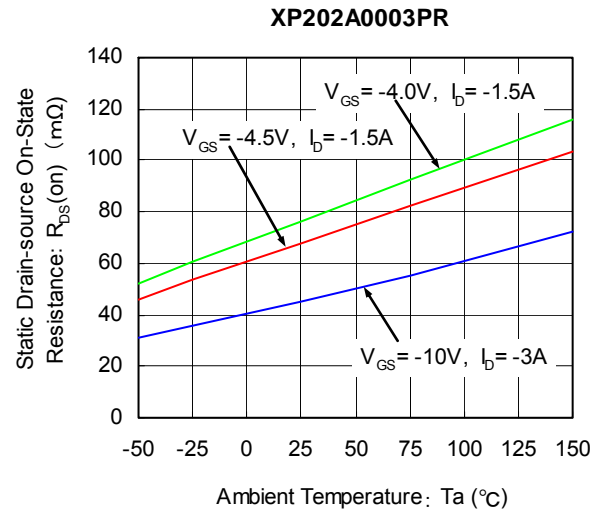

(5) Forward Transfer Admittance vs. Drain Current

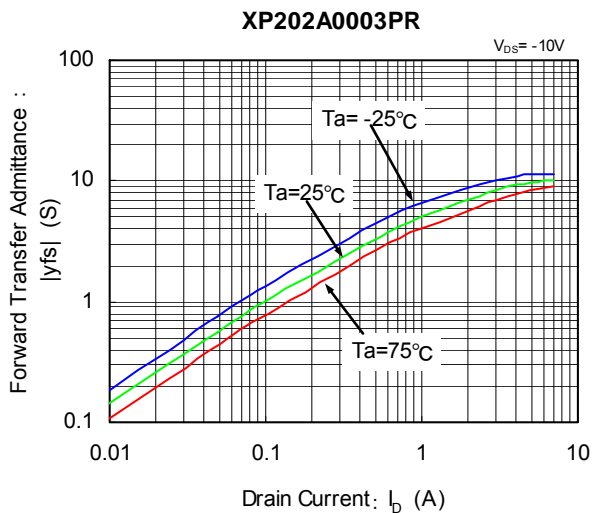

(6) Source Current vs. Diode Forward Voltage

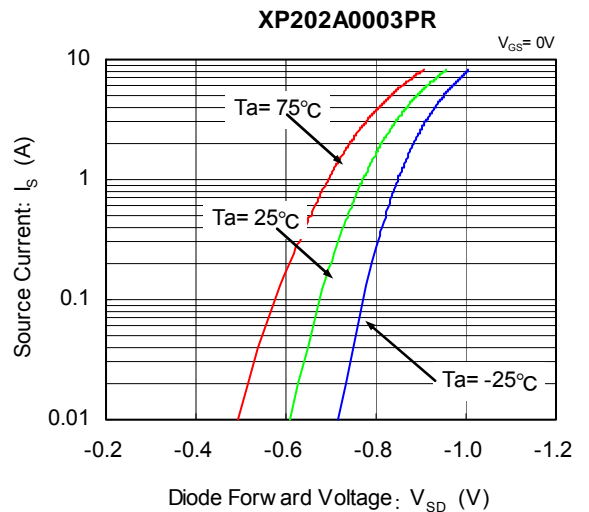

(7) Switching Time vs. Drain Current

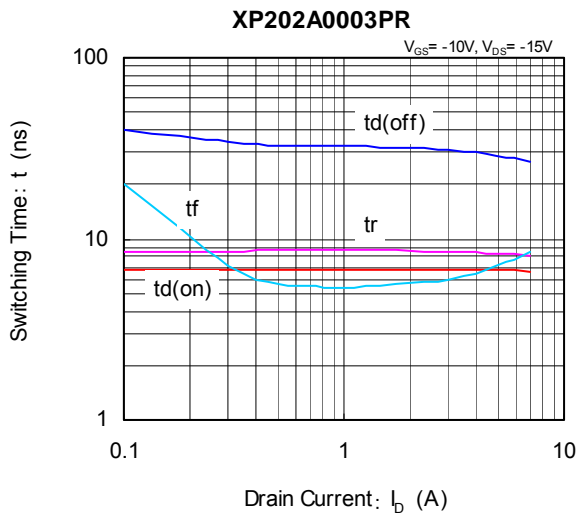

(8) Ciss, Coss, Crss vs. Drain-Source Voltage

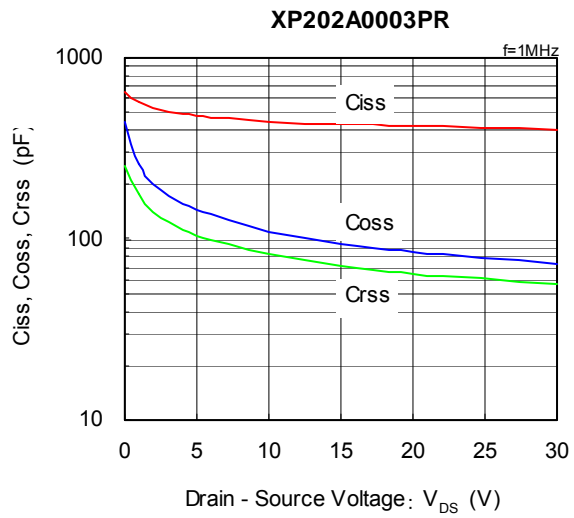

(9) Gate-Source Voltage vs. Gate Charge

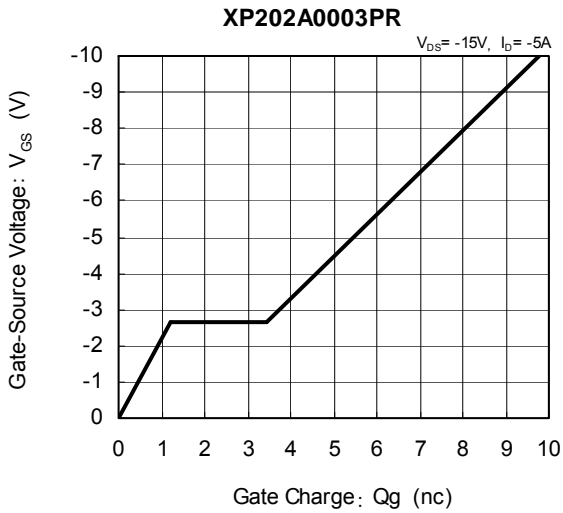

(10) Area of Safe Operation

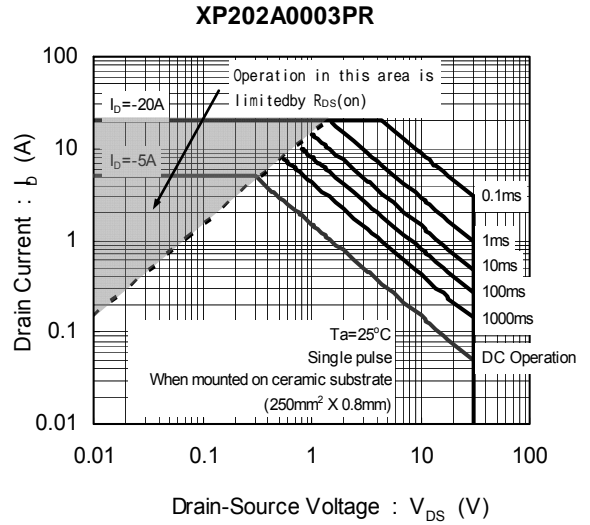

1. The products and product specifications contained herein are subject to change without notice to improve performance characteristics. Consult us, or our representatives before use, to confirm that the information in this datasheet is up to date.
2. We assume no responsibility for any infringement of patents, patent rights, or other rights arising from the use of any information and circuitry in this datasheet.
3. Please ensure suitable shipping controls (including fail-safe designs and aging protection) are in force for equipment employing products listed in this datasheet.
4. The products in this datasheet are not developed, designed, or approved for use with such equipment whose failure of malfunction can be reasonably expected to directly endanger the life of, or cause significant injury to, the user.
(e.g. Atomic energy; aerospace; transport; combustion and associated safety equipment thereof.)
5. Please use the products listed in this datasheet within the specified ranges.
Should you wish to use the products under conditions exceeding the specifications, please consult us or our representatives.
6. We assume no responsibility for damage or loss due to abnormal use.
7. All rights reserved. No part of this datasheet may be copied or reproduced without the prior permission of TOREX SEMICONDUCTOR LTD.

TOREX SEMICONDUCTOR LTD.