

F5055

FUJI Intelligent Power MOSFET

Intelligent Power MOSFET

■ Features

- Two N-ch power MOSFET circuits
- Over temperature protection
- Short circuit protection
- Low on-resistance
- High speed switching

■ Applications

- Solenoid driver
- Lamp driver
- Replacements for fuse and relay

■ Outline drawings [mm]

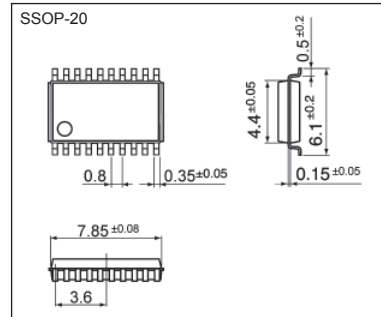

■ Connection

TERMINAL No.	FUNCTION
①	DRAIN 1
②③	SOURCE 1
④	GATE 1
⑤	NC
⑥⑦	SOURCE 2
⑧	GATE 2
⑨	NC
⑩	DRAIN 2
⑪~⑬	DRAIN 2
⑭~⑲	DRAIN 1

■ Maximum ratings and characteristics

● Absolute maximum ratings (at Tc=25°C, unless otherwise specified)

Description	Symbol	Characteristics	Unit	Remarks
Drain-source voltage	V _{DSS}	40	V	DC
Gate-source voltage	V _{GSS}	-0.3~7.0	V	DC
Continuous drain current	I _D	5.9	A	for each channel
Maximum power dissipation	P _D	7.8	W	for each channel
Operating junction temperature	T _j	150	°C	-
Storage temperature range	T _{stg}	-55 ~ 150	°C	-
Single pulse inductive load switch-off energy dissipation	E _{CL}	100	mJ	T _j =150°C, L=5mH, I _{DP} =8A Single pulse, dv/dt≤10V/μs for each channel

● Electrical characteristics (at Tc=25°C unless otherwise specified)

Description	Symbol	Conditions	min.	typ.	max.	Unit
Drain-source clamp voltage	V _{DSS}	I _D =1mA, V _{GS} =0V	40	-	60	V
Gate threshold voltage	V _{GS(th)}	I _D =10mA, V _{DS} =13V	1.0	-	2.8	V
Operation gate voltage (protection circuit operates)	V _{GS(p)}	-	2.8	-	7.0	V
Zero gate voltage drain current	I _{DSS}	V _{DS} =16V, V _{GS} =0~1.5V	-	-	60	μA
		V _{DS} =30V, V _{GS} =0~1.5V	-	-	1	mA
Gate-source leakage current	I _{GS(un)*}	V _{GS} =5V	-	-	250	μA
		V _{GS} =5V, T _j >150°C	-	-	350	μA
Drain-source on-state resistance	R _{DS(on)}	I _D =5A, V _{GS} =5V	-	-	140	mΩ
Turn-on time	t _{on}	V _{DS} =13V, I _D =0.5A, V _{GS} =5V	-	-	50	μs
Turn-off time	t _{off}		-	-	50	μs
Over-temperature protection	T _{trip}	V _{GS} =5V	150	-	-	°C
Short circuit protection	I _{oc}	V _{GS} =5V	12	-	32	A

Note * : Under normal operation

Note ** : Under self protection (Short circuit ~ Short circuit protection ~ Over-temperature protection)

● Electrical characteristics (at Tc=-40~105°C unless otherwise specified)

Description	Symbol	Conditions	min.	typ.	max.	Unit
Drain-source clamp voltage	V _{DSS}	I _D =1mA, V _{GS} =0V	38	-	62	V
Gate threshold voltage	V _{GS(th)}	I _D =10mA, V _{DS} =14V	1.0	-	3.0	V
Operation gate voltage (protection circuit operates)	V _{GS(p)}	-	3.0	-	6.7	V
Zero gate voltage drain current	I _{DSS}	V _{DS} =16V, V _{GS} =0V	-	-	100	μA
		V _{DS} =30V, V _{GS} =0V	-	-	1.6	mA
Gate-source leakage current	I _{GS(un)*}	V _{GS} =5V	-	-	300	μA
		V _{GS} =5V, T _j >150°C	-	-	350	μA
Drain-source on-state resistance	R _{DS(on)}	I _D =5A, V _{GS} =5V	-	-	205	mΩ
Turn-on time	t _{on}	V _{DS} =13V, I _D =5A, V _{GS} =5V	-	-	62	μs
Turn-off time	t _{off}		-	-	52	μs
Short circuit protection	I _{oc}	V _{GS} =5V	8.4	-	42	A

Note * : Under normal operation

Note ** : Under self protection (Short circuit ~ Short circuit protection ~ Over-temperature protection)

● Thermal resistance

Description	Symbol	Test conditions	min.	typ.	max.	Unit
Thermal resistance	R _{th(j-c)}	Junction-case	-	-	16.0	°C/W

■ Timing chart

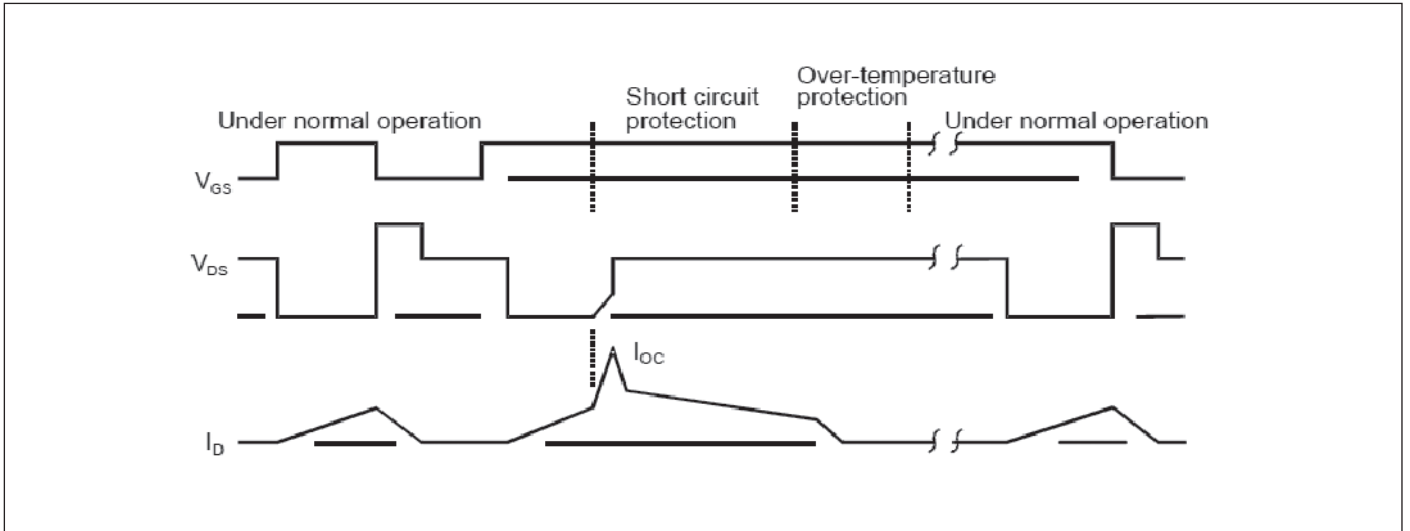

■ Circuit block diagram

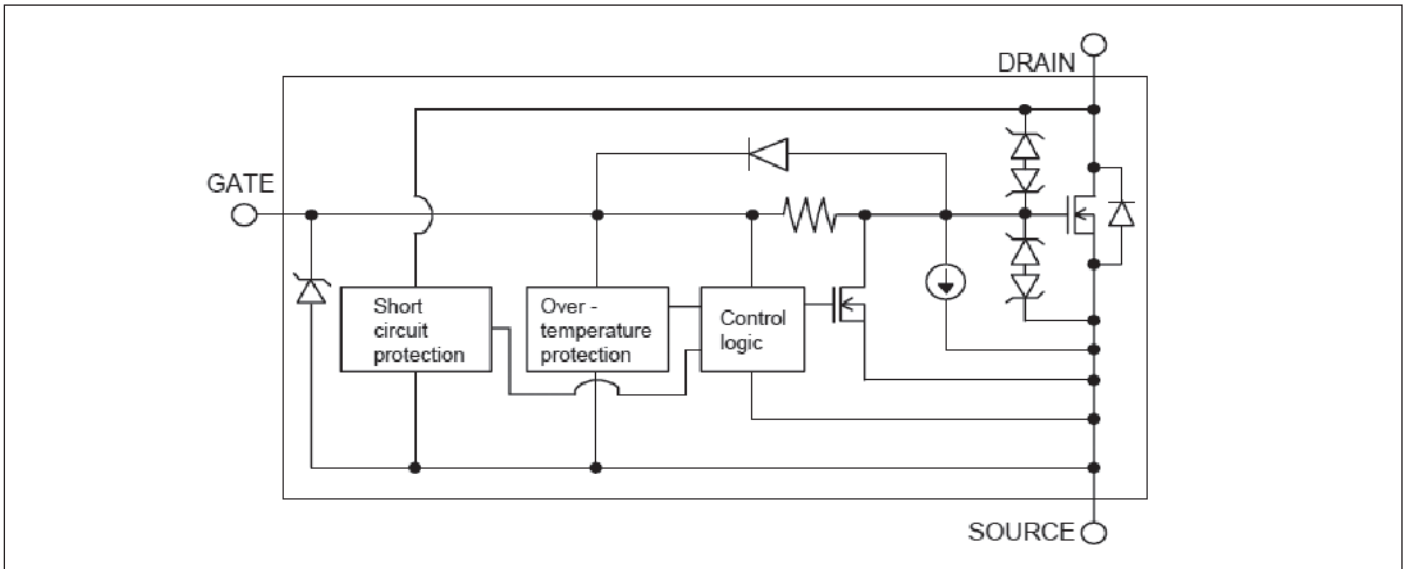

Drain-source breakdown voltage
 $V_{DSS}=f(T_j): I_D=1\text{mA}, V_{GS}=0\text{V}$

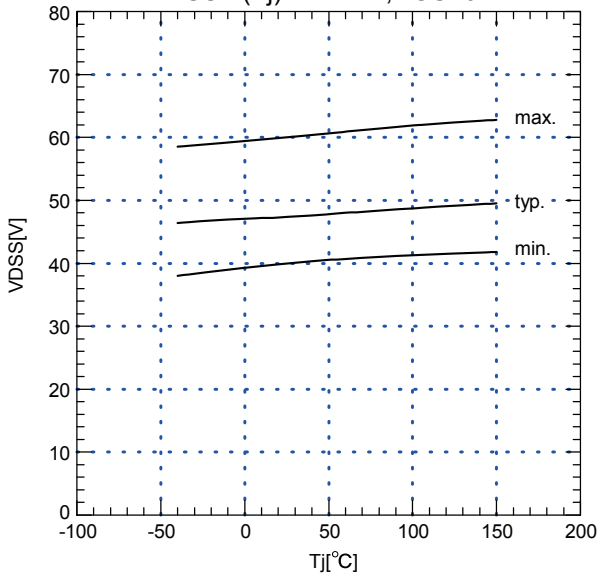

Gate threshold voltage
 $V_{GS(th)}=f(T_j): V_{DS}=13\text{V}, I_D=10\text{mA}$

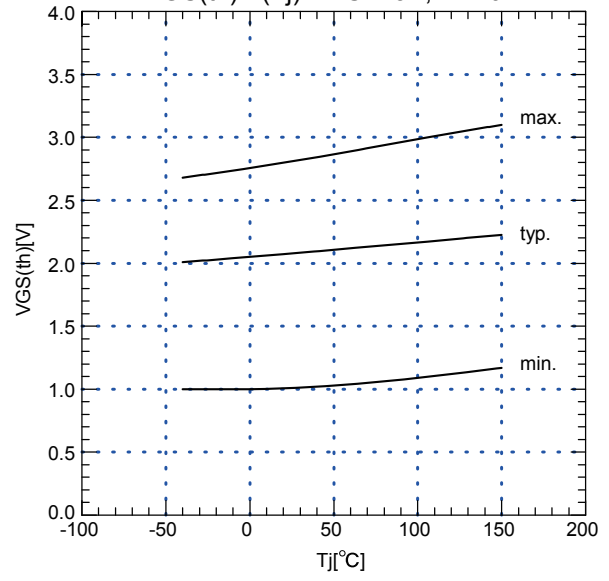

Gate-source leakage current
 $I_{GS(n)}=f(T_j): V_{GS}=5\text{V}, V_{DS}=0\text{V}$

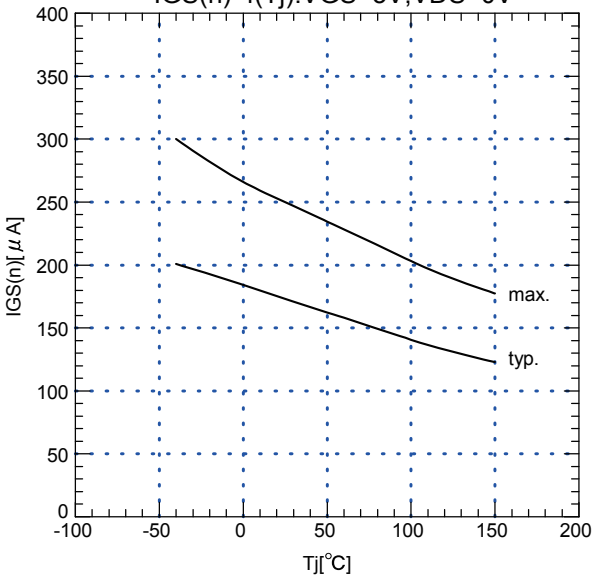

Gate-source leakage current
 $I_{GS(n)}=f(V_{GS}): T_j=25^\circ\text{C}, V_{DS}=0\text{V}$

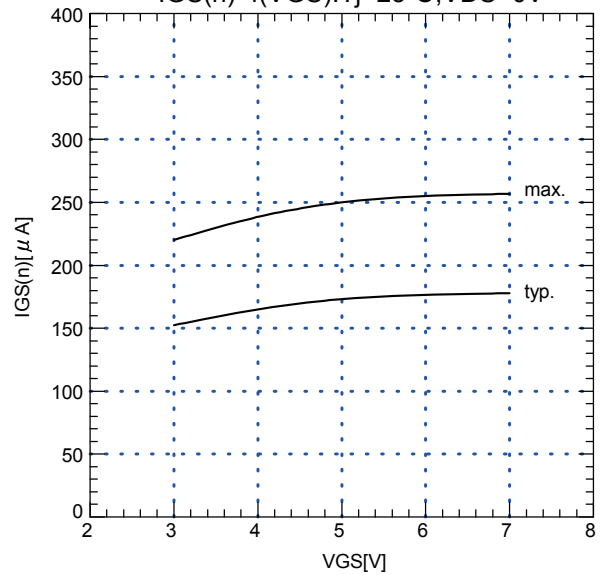

Drain-source on-state resistance
 $R_{DS(on)}=f(T_j): I_D=5\text{A}, V_{GS}=5\text{V}$

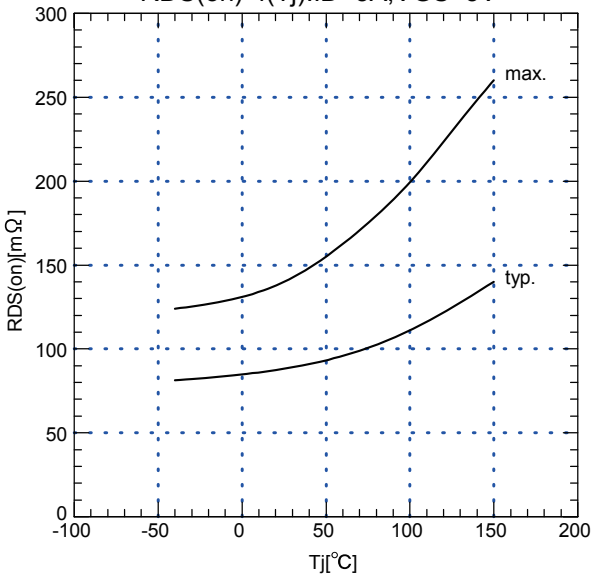

Drain-source on-state resistance
 $R_{DS(on)}=f(T_j): I_D=5\text{A}, T_j=25^\circ\text{C}$

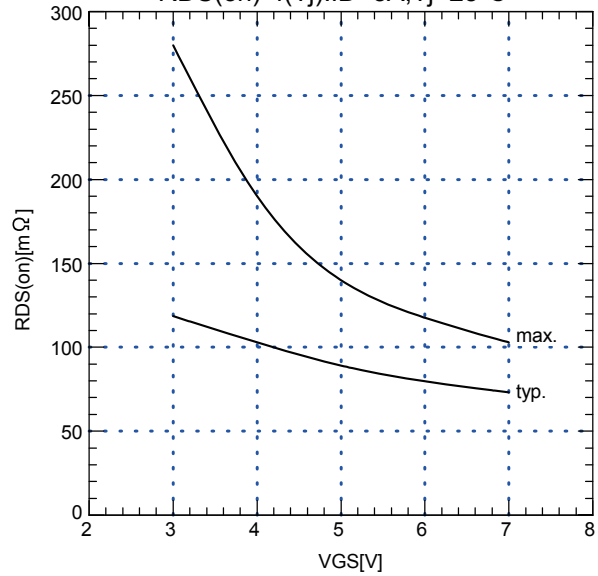

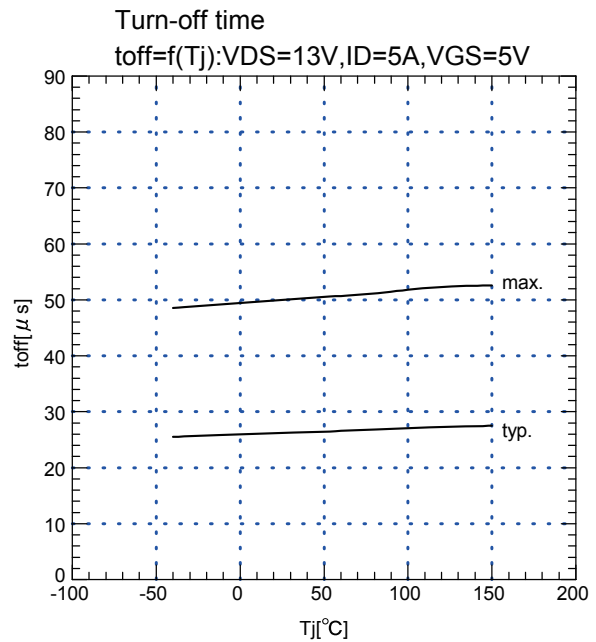
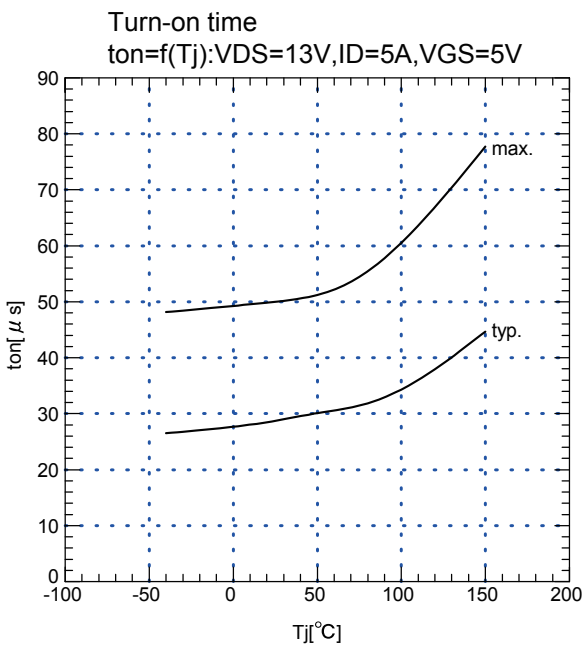
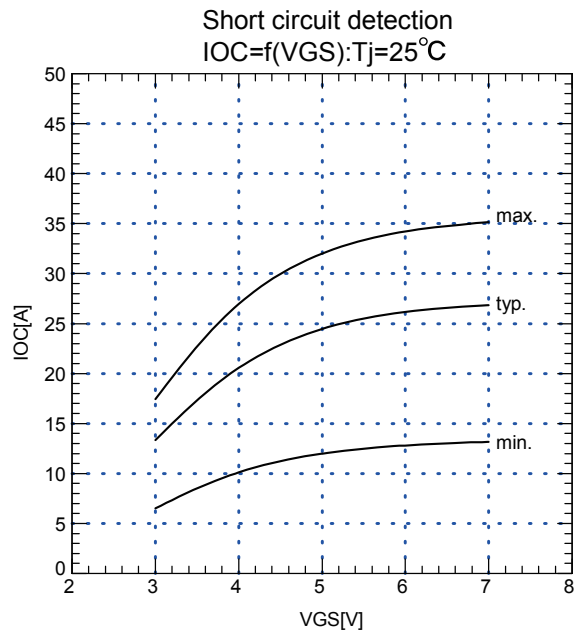
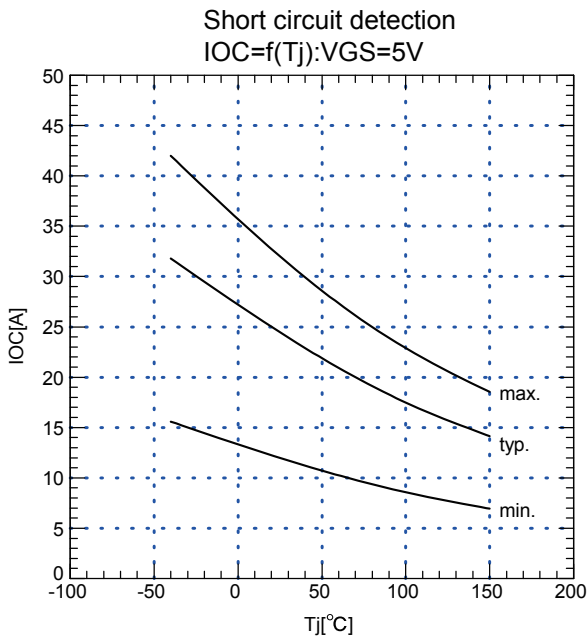
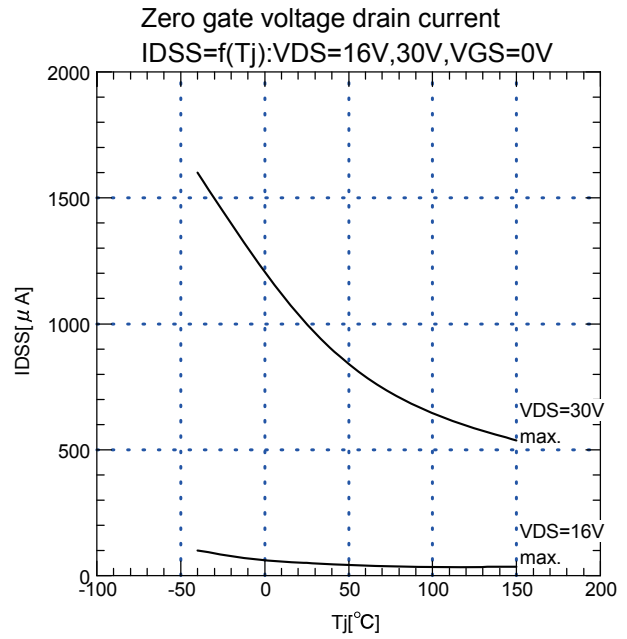
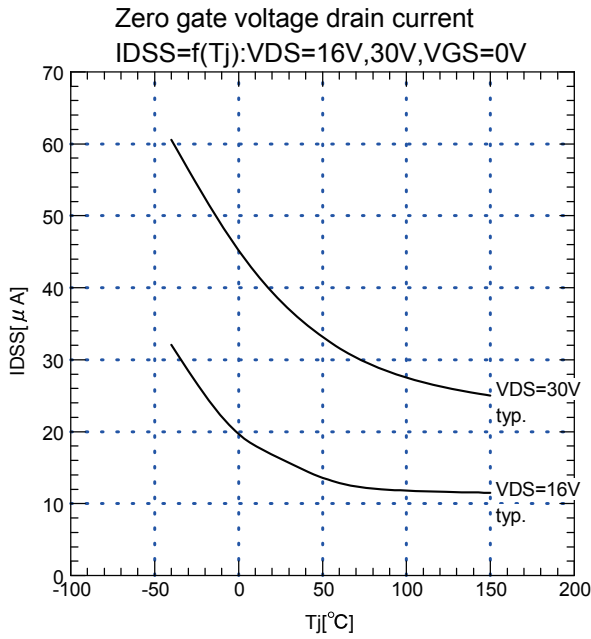

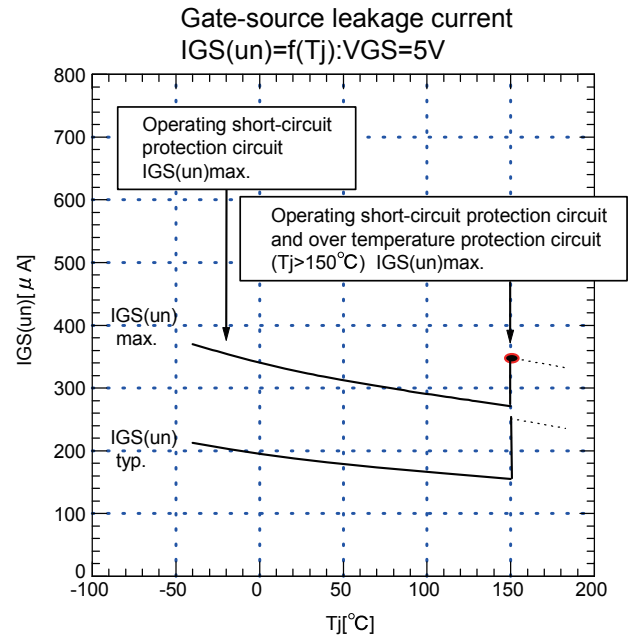
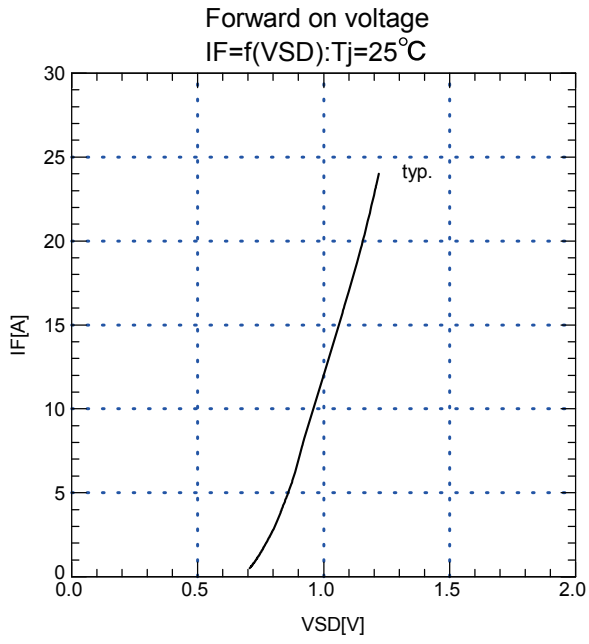

WARNING

1. This Catalog contains the product specifications, characteristics, data, materials, and structures as of March 2010. The contents are subject to change without notice for specification changes or other reasons. When using a product listed in this Catalog, be sure to obtain the latest specifications.
2. All applications described in this Catalog exemplify the use of Fuji's products for your reference only. No right or license, either express or implied, under any patent, copyright, trade secret or other intellectual property right owned by Fuji Electric Systems Co., Ltd. is (or shall be deemed) granted. Fuji Electric Systems Co., Ltd. makes no representation or warranty, whether express or implied, relating to the infringement or alleged infringement of other's intellectual property rights which may arise from the use of the applications described herein.
3. Although Fuji Electric Systems Co., Ltd. is enhancing product quality and reliability, a small percentage of semiconductor products may become faulty. When using Fuji Electric semiconductor products in your equipment, you are requested to take adequate safety measures to prevent the equipment from causing a physical injury, fire, or other problem if any of the products become faulty. It is recommended to make your design fail-safe, flame retardant, and free of malfunction.
4. The products introduced in this Catalog are intended for use in the following electronic and electrical equipment which has normal reliability requirements.
 - Computers
 - OA equipment
 - Communications equipment (terminal devices)
 - Measurement equipment
 - Machine tools
 - Audiovisual equipment
 - Electrical home appliances
 - Personal equipment
 - Industrial robots etc.
5. If you need to use a product in this Catalog for equipment requiring higher reliability than normal, such as for the equipment listed below, it is imperative to contact Fuji Electric Systems Co., Ltd. to obtain prior approval. When using these products for such equipment, take adequate measures such as a backup system to prevent the equipment from malfunctioning even if a Fuji's product incorporated in the equipment becomes faulty.
 - Transportation equipment (mounted on cars and ships)
 - Trunk communications equipment
 - Traffic-signal control equipment
 - Gas leakage detectors with an auto-shut-off feature
 - Emergency equipment for responding to disasters and anti-burglary devices
 - Safety devices
 - Medical equipment
6. Do not use products in this Catalog for the equipment requiring strict reliability such as the following and equivalents to strategic equipment (without limitation).
 - Space equipment
 - Aeronautic equipment
 - Nuclear control equipment
 - Submarine repeater equipment
7. Copyright ©1996-2008 by Fuji Electric Systems Co., Ltd. All rights reserved.
No part of this Catalog may be reproduced in any form or by any means without the express permission of Fuji Electric Systems Co., Ltd.
8. If you have any question about any portion in this Catalog, ask Fuji Electric Systems Co., Ltd. or its sales agents before using the product.
Neither Fuji Electric Systems Co., Ltd. nor its agents shall be liable for any injury caused by any use of the products not in accordance with instructions set forth herein.