

FUJI POWER MOSFET Super FAP-G Series

N-CHANNEL SILICON POWER MOSFET

Features

- High speed switching
- Low on-resistance
- No secondary breakdown
- Low driving power
- Avalanche-proof

Applications

- Switching regulators
- UPS (Uninterruptible Power Supply)
- DC-DC converters

Maximum ratings and characteristic Absolute maximum ratings

(T_c=25°C unless otherwise specified)

Item	Symbol	Ratings	Unit
Drain-source voltage	V _{DS}	100	V
	V _{DSX} *5	70	V
Continuous drain current	I _D	±29	A
Pulsed drain current	I _{D(puls)}	±116	A
Gate-source voltage	V _{GS}	±30	V
Non-repetitive Avalanche current	I _{AS} *2	29	A
Maximum Avalanche Energy	E _{AS} *1	155.8	mJ
Maximum Drain-Source dV/dt	dV _{DS} /dt *4	20	kV/μs
Peak Diode Recovery dV/dt	dV/dt *3	5	kV/μs
Max. power dissipation	P _D	T _a =25°C	1.67
		T _c =25°C	105
Operating and storage temperature range	T _{ch}	+150	°C
	T _{stg}	-55 to +150	°C

*1 L=222μH, V_{CC}=48V, T_{ch}=25°C, See to Avalanche Energy Graph *2 T_{ch} ≤ 150°C

*3 I_F ≤ -I_D, -di/dt=50A/μs, V_{CC} ≤ BV_{DSS}, T_{ch} ≤ 150°C *4 V_{DS} ≤ 100V *5 V_{GS}=-30V

Electrical characteristics (T_c =25°C unless otherwise specified)

Item	Symbol	Test Conditions	Min.	Typ.	Max.	Units
Drain-source breakdown voltage	V _{(BR)DSS}	I _D = 250μA V _{GS} =0V	100			V
Gate threshold voltage	V _{GS(th)}	I _D = 250μA V _{DS} =V _{GS}	3.0		5.0	V
Zero gate voltage drain current	I _{DSS}	V _{DS} =100V V _{GS} =0V V _{DS} =80V V _{GS} =0V	T _{ch} =25°C		25	μA
			T _{ch} =125°C		250	
Gate-source leakage current	I _{GSS}	V _{GS} =±30V V _{DS} =0V		10	100	nA
Drain-source on-state resistance	R _{DS(on)}	I _D =10A V _{GS} =10V		47	62	mΩ
Forward transconductance	g _{fs}	I _D =10A V _{DS} =25V	6	12		S
Input capacitance	C _{iss}	V _{DS} =75V V _{GS} =0V f=1MHz		730	1095	pF
Output capacitance	C _{oss}			190	285	
Reverse transfer capacitance	C _{rss}			12	18	
Turn-on time t _{on}	td(on)	V _{CC} =48V I _D =10A V _{GS} =10V		12	18	ns
	t _r			3.8	6	
Turn-off time t _{off}	td(off)	R _{GS} =10 Ω		23	35	ns
	t _f			8.5	13	
Total Gate Charge	Q _G	V _{CC} =50V		22	33	nC
Gate-Source Charge	Q _{GS}	I _D =20A		9	13.5	
Gate-Drain Charge	Q _{GD}	V _{GS} =10V		6	9	
Avalanche capability	I _{AV}	L=222μH T _{ch} =25°C	29			A
Diode forward on-voltage	V _{SD}	I _F =20A V _{GS} =0V T _{ch} =25°C		1.10	1.65	V
Reverse recovery time	t _{rr}	I _F =20A V _{GS} =0V		65		ns
Reverse recovery charge	Q _{rr}	-di/dt=100A/μs T _{ch} =25°C		0.17		μC

Thermal characteristics

Item	Symbol	Test Conditions	Min.	Typ.	Max.	Units
Thermal resistance	R _{th(ch-c)}	channel to case			1.191	°C/W
	R _{th(ch-a)}	channel to ambient			75.0	°C/W

Outline Drawings (mm)

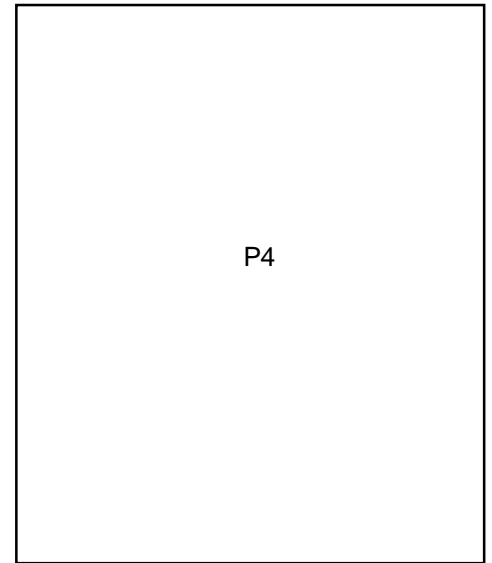

Equivalent circuit schematic

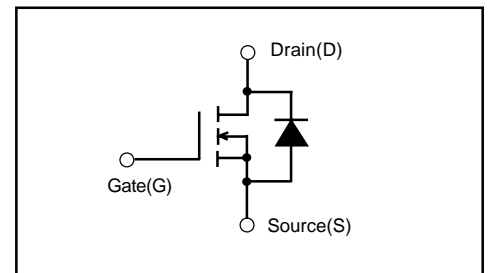

Characteristics

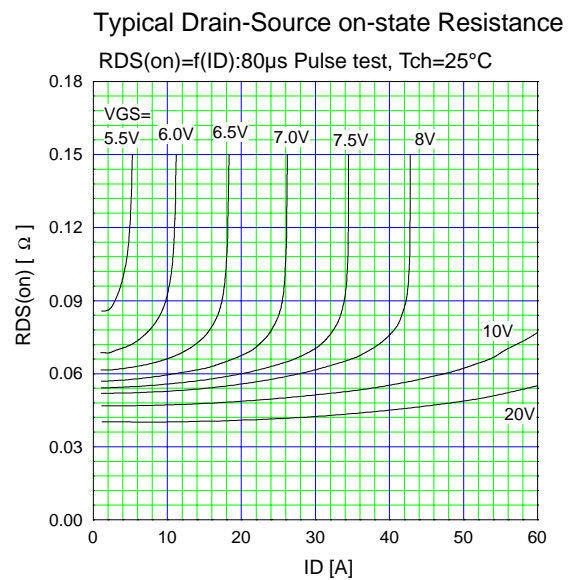
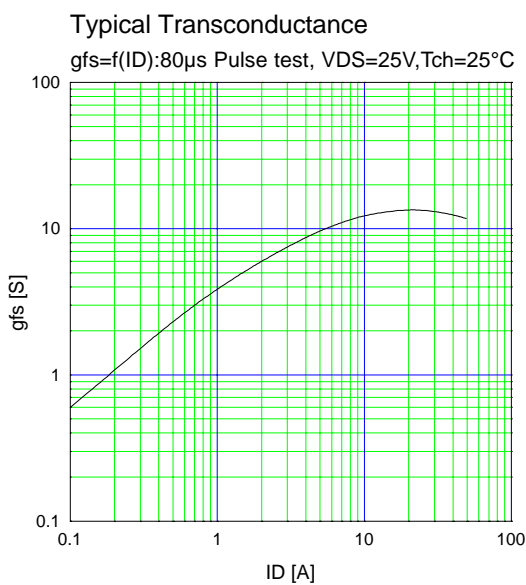
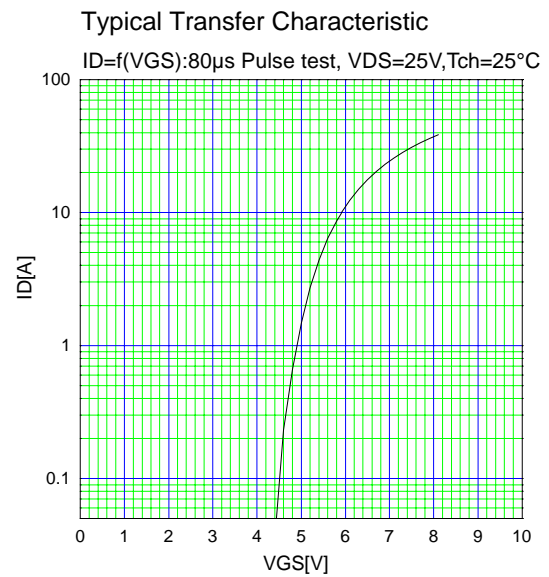
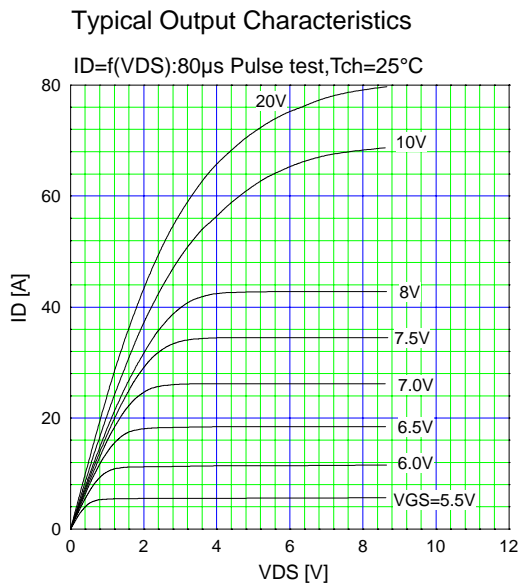
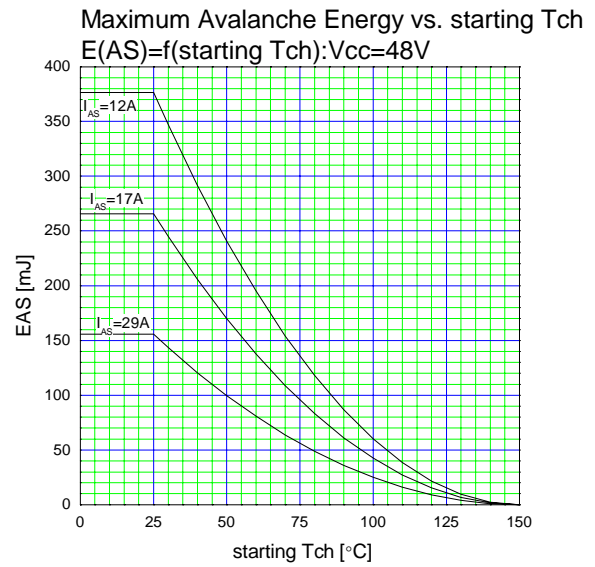
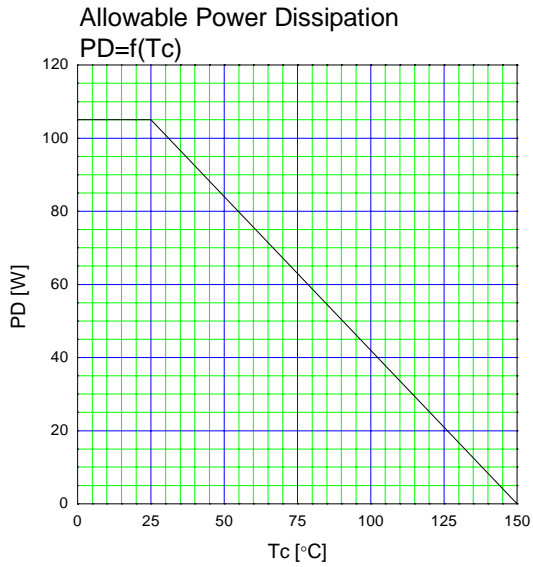

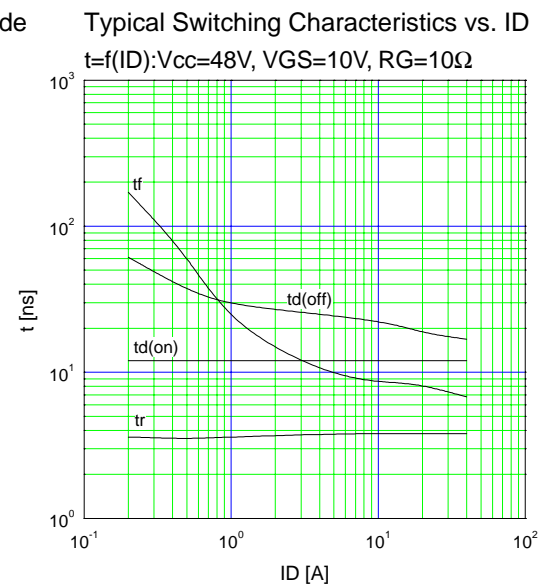
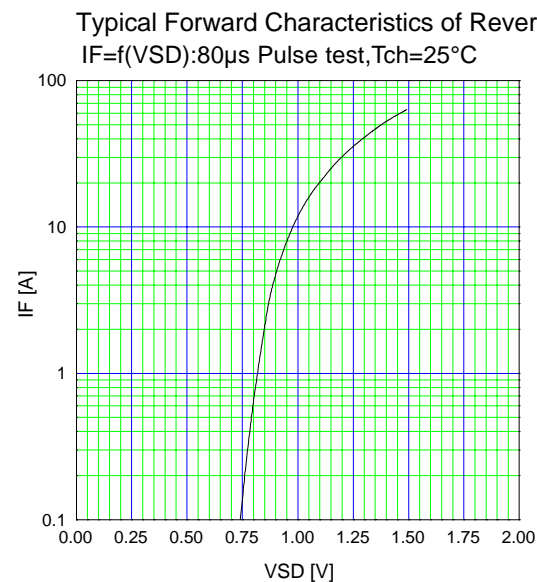
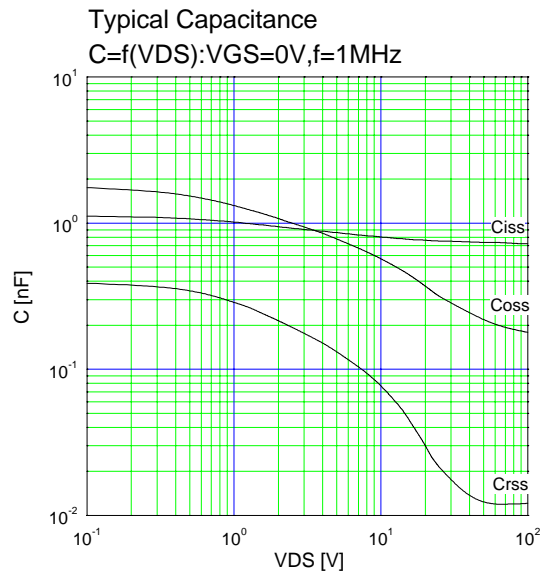
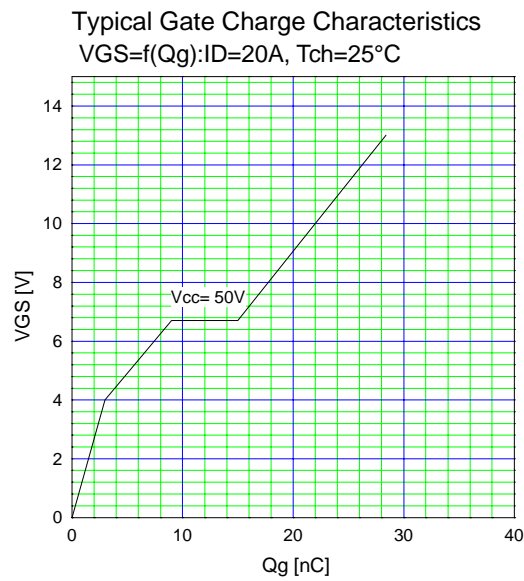
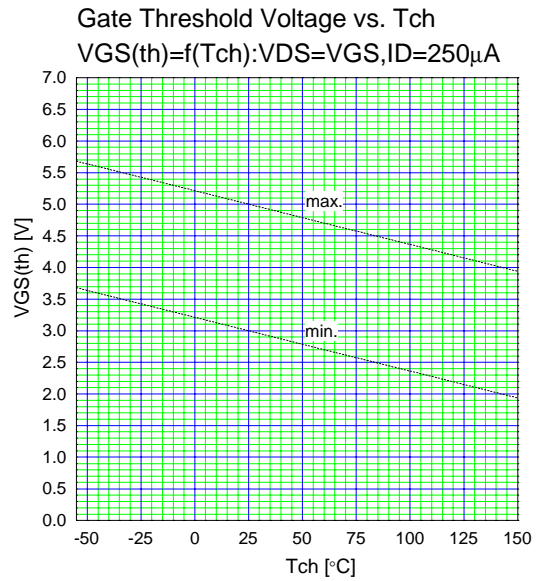
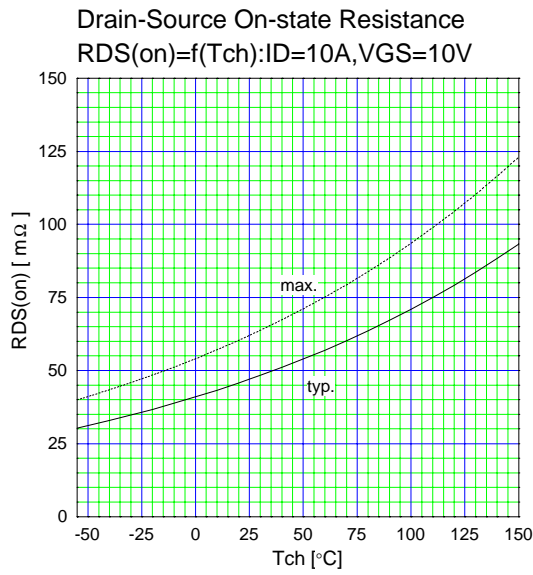

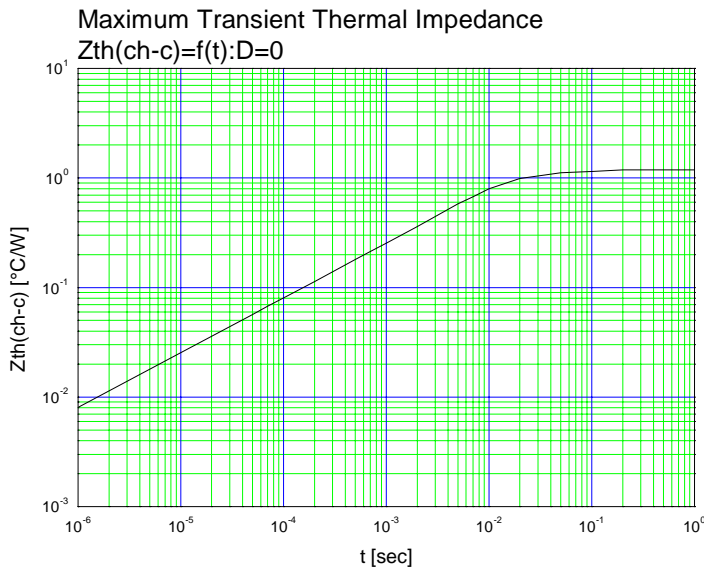
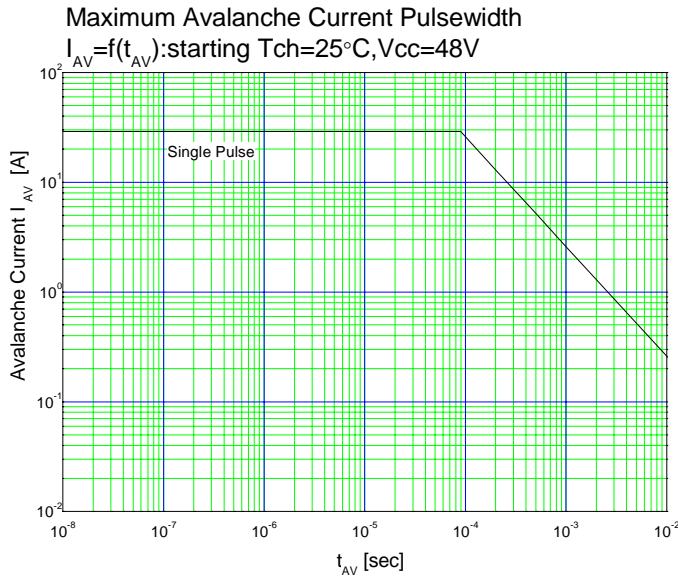

Outline Drawings (mm)

Type(L)

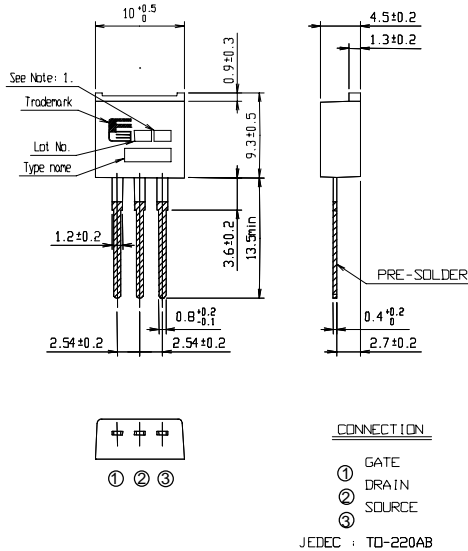

Type(S)

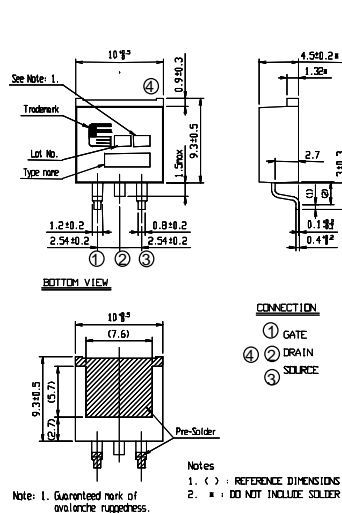

Type(SJ)

