

## FUJI POWER MOSFET Super FAP-G Series

### N-CHANNEL SILICON POWER MOSFET

#### Features

- High speed switching
- Low on-resistance
- No secondary breakdown
- Low driving power
- Avalanche-proof

#### Applications

- Switching regulators
- UPS (Uninterruptible Power Supply)
- DC-DC converters

#### Maximum ratings and characteristic Absolute maximum ratings

(T<sub>c</sub>=25°C unless otherwise specified)

Item	Symbol	Ratings	Unit
Drain-source voltage	V <sub>DS</sub>	150	V
	V <sub>DSX</sub> *5	120	V
Continuous drain current	I <sub>D</sub>	±57	A
Pulsed drain current	I <sub>D(puls)</sub>	±228	A
Gate-source voltage	V <sub>GS</sub>	±30	V
Non-repetitive Avalanche current	I <sub>AS</sub> *2	57	A
Maximum Avalanche Energy	E <sub>AS</sub> *1	272.5	mJ
Maximum Drain-Source dV/dt	dV <sub>DS</sub> /dt *4	20	kV/μs
Peak Diode Recovery dV/dt	dV/dt *3	5	kV/μs
Max. power dissipation	P <sub>D</sub>	T <sub>a</sub> =25°C	2.02
		T <sub>c</sub> =25°C	270
Operating and storage temperature range	T <sub>ch</sub>	+150	°C
	T <sub>stg</sub>	-55 to +150	°C

\*1 L=123μH, V<sub>CC</sub>=48V, See to Avalanche Energy Graph \*2 T<sub>ch</sub> ≤150°C

\*3 I<sub>F</sub> ≤ -I<sub>D</sub>, -di/dt=50A/μs, V<sub>CC</sub> ≤ BV<sub>DSS</sub>, T<sub>ch</sub> ≤ 150°C \*4 V<sub>DS</sub> ≤150V \*5 V<sub>GS</sub>=-30V

#### Electrical characteristics (T<sub>c</sub> =25°C unless otherwise specified)

Item	Symbol	Test Conditions	Min.	Typ.	Max.	Units
Drain-source breakdown voltage	V <sub>(BR)DSS</sub>	I <sub>D</sub> = 250μA V <sub>GS</sub> =0V	150			V
Gate threshold voltage	V <sub>GS(th)</sub>	I <sub>D</sub> = 250μA V <sub>DS</sub> =V <sub>GS</sub>	3.0		5.0	V
Zero gate voltage drain current	I <sub>DSS</sub>	V <sub>DS</sub> =150V V <sub>GS</sub> =0V			25	μA
		V <sub>DS</sub> =120V V <sub>GS</sub> =0V			250	
Gate-source leakage current	I <sub>GSS</sub>	V <sub>GS</sub> =±30V V <sub>DS</sub> =0V		10	100	nA
Drain-source on-state resistance	R <sub>DS(on)</sub>	I <sub>D</sub> =20A V <sub>GS</sub> =10V		31	41	mΩ
Forward transconductance	g <sub>fs</sub>	I <sub>D</sub> =20A V <sub>DS</sub> =25V	13	26		S
Input capacitance	C <sub>iss</sub>	V <sub>DS</sub> =75V		1940	2910	pF
Output capacitance	C <sub>oss</sub>	V <sub>GS</sub> =0V		310	465	
Reverse transfer capacitance	C <sub>rss</sub>	f=1MHz		24	36	
Turn-on time t <sub>on</sub>	td(on)	V <sub>CC</sub> =48V I <sub>D</sub> =20A		20	30	ns
	t <sub>r</sub>	V <sub>GS</sub> =10V		26	39	
Turn-off time t <sub>off</sub>	td(off)	R <sub>GS</sub> =10 Ω		50	75	
	t <sub>f</sub>			20	30	
Total Gate Charge	Q <sub>G</sub>	V <sub>CC</sub> =75V		52	78	nC
Gate-Source Charge	Q <sub>GS</sub>	I <sub>D</sub> =40A		15	22.5	
Gate-Drain Charge	Q <sub>GD</sub>	V <sub>GS</sub> =10V		18	27	
Avalanche capability	I <sub>AV</sub>	L=123μH T <sub>ch</sub> =25°C	57			A
Diode forward on-voltage	V <sub>SD</sub>	I <sub>F</sub> =40A V <sub>GS</sub> =0V T <sub>ch</sub> =25°C		1.10	1.65	V
Reverse recovery time	t <sub>rr</sub>	I <sub>F</sub> =40A V <sub>GS</sub> =0V		0.14		μs
Reverse recovery charge	Q <sub>rr</sub>	-di/dt=100A/μs T <sub>ch</sub> =25°C		0.77		μC

#### Thermal characteristics

Item	Symbol	Test Conditions	Min.	Typ.	Max.	Units
Thermal resistance	R <sub>th(ch-c)</sub>	channel to case			0.463	°C/W
	R <sub>th(ch-a)</sub>	channel to ambient			62.0	°C/W

#### Outline Drawings (mm)

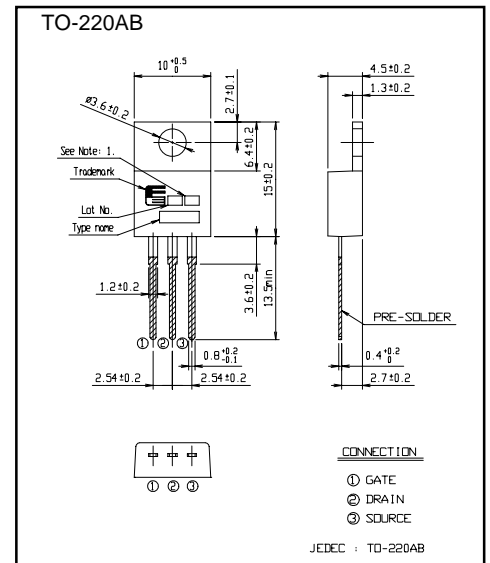

#### Equivalent circuit schematic

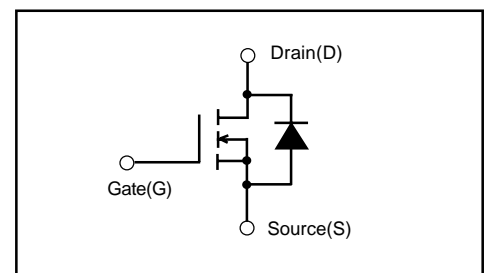

## Characteristics

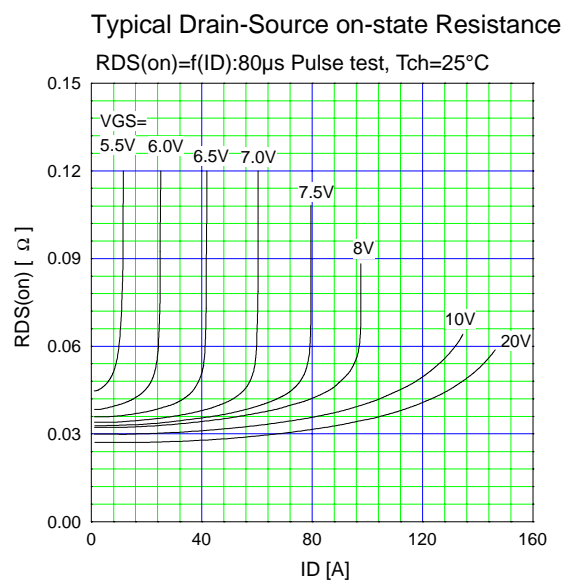
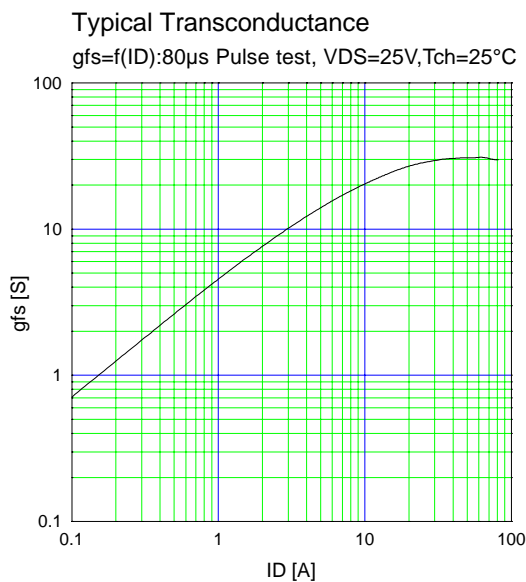
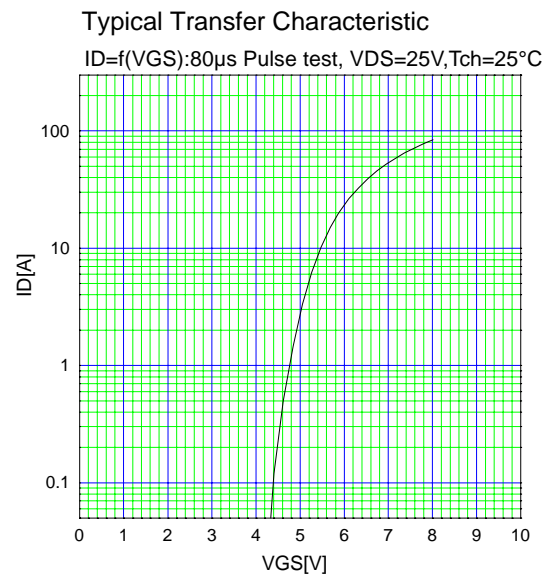
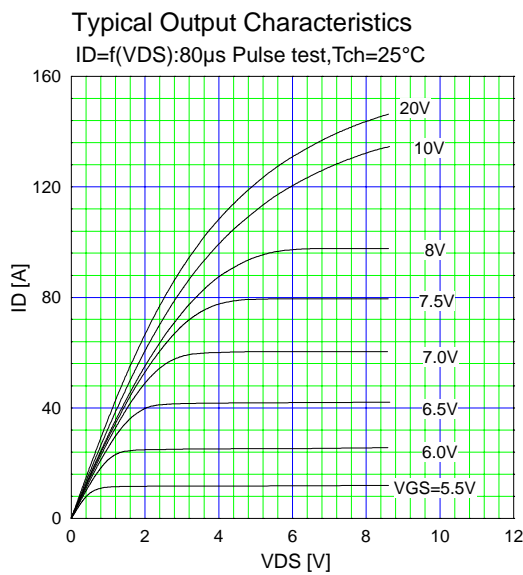
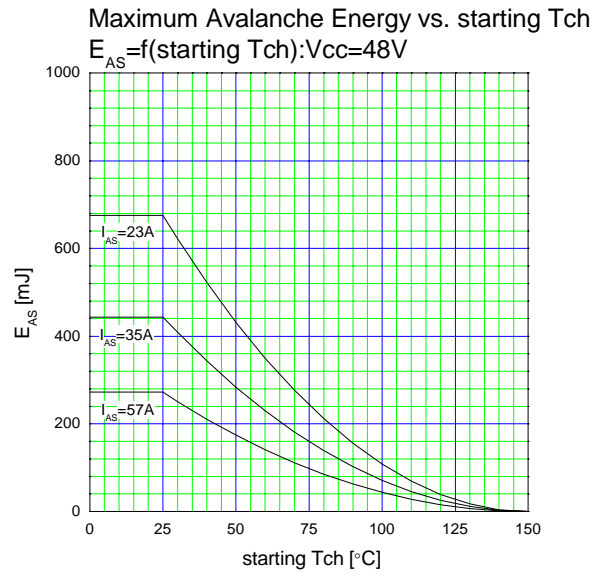
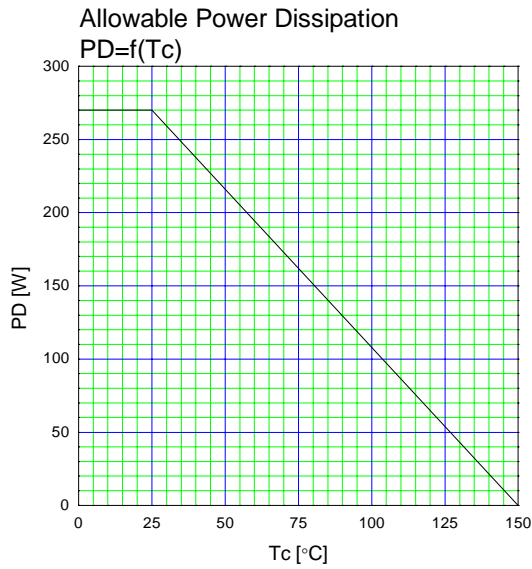

Drain-Source On-state Resistance  
 $R_{DS(on)}=f(T_{ch}):I_D=20A, V_{GS}=10V$

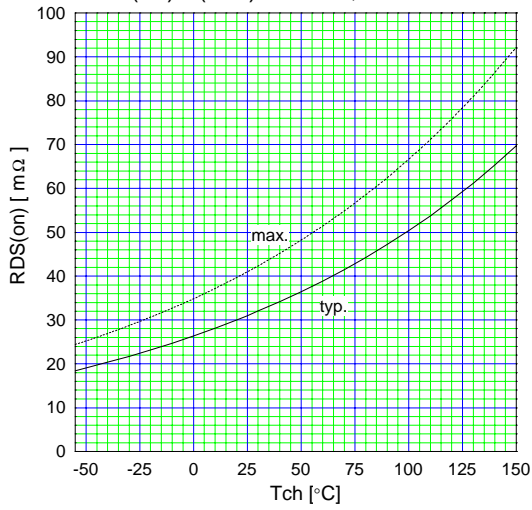

Gate Threshold Voltage vs.  $T_{ch}$   
 $V_{GS(th)}=f(T_{ch}):V_{DS}=V_{GS}, I_D=250\mu A$

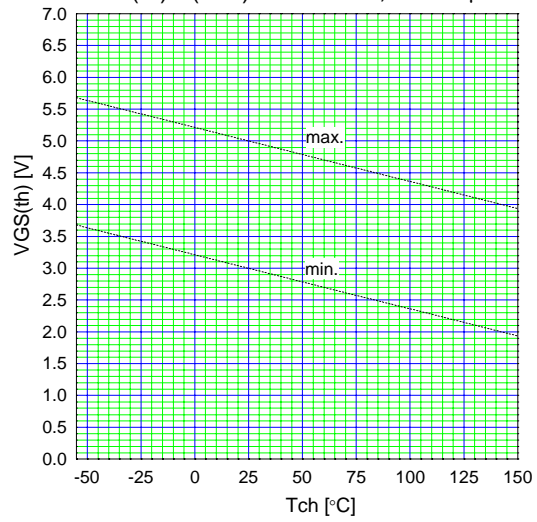

Typical Gate Charge Characteristics  
 $V_{GS}=f(Q_g):I_D=40A, T_{ch}=25^{\circ}C$

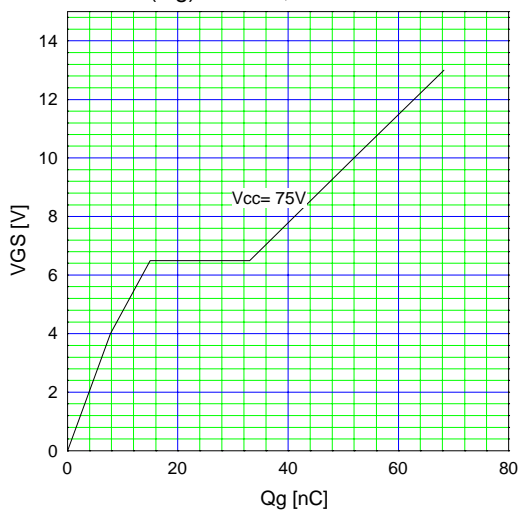

Typical Capacitance  
 $C=f(V_{DS}):V_{GS}=0V, f=1MHz$

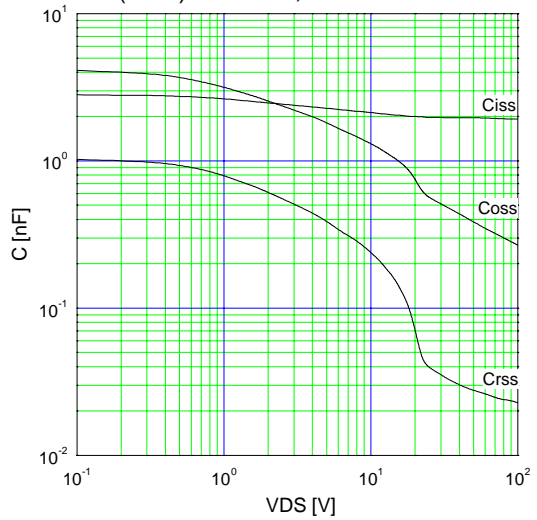

Typical Forward Characteristics of Reverse Diode  
 $I_F=f(V_{SD}):80\mu s$  Pulse test,  $T_{ch}=25^{\circ}C$

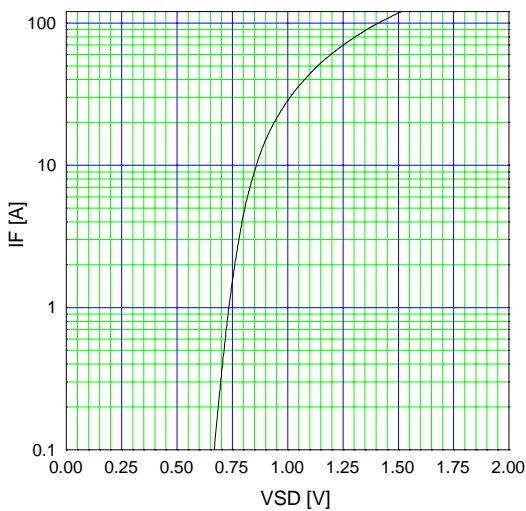

Typical Switching Characteristics vs.  $I_D$   
 $t=f(I_D):V_{CC}=48V, V_{GS}=10V, R_G=10\Omega$

