

N-CHANNEL SILICON POWER MOSFET

FAP-IIIB SERIES

■ Features

- High speed switching
- Low on-resistance
- No secondary breakdown
- Low driving power
- High voltage
- Avalanche-proof

■ Applications

- Switching regulators
- DC-DC converters
- General purpose power amplifier

■ Outline Drawings

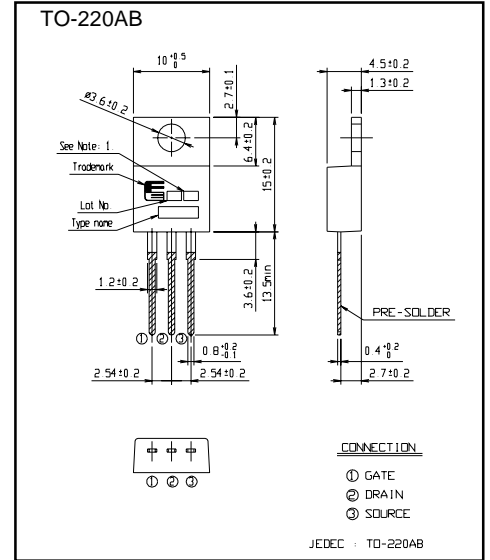

■ Maximum ratings and characteristics

● Absolute maximum ratings (Tc=25°C unless otherwise specified)

Item	Symbol	Rating	Unit	Remarks
Drain-source voltage	V _{DS}	30	V	
Continuous drain current	I _D	±35	A	
Pulsed drain current	I _D [puls]	±140	A	
Gate-source peak voltage	V _{GS}	±16	V	
Maximum avalanche energy	E _{AV}	129.3	mJ	*1
Maximum power dissipation	P _D	30	W	
Operating and storage temperature range	T _{ch}	+150	°C	
	T _{stg}	-55 to +150	°C	

*1 L=0.70mH, V_{CC}=12V

■ Equivalent circuit schematic

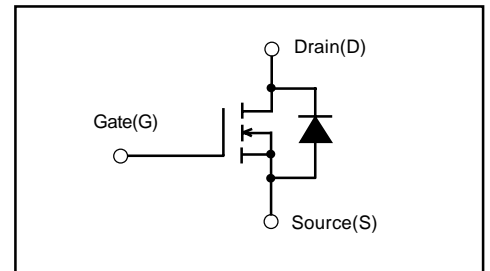

● Electrical characteristics (Tc =25°C unless otherwise specified)

Item	Symbol	Test Conditions	Min.	Typ.	Max.	Units	
Drain-source breakdown voltage	V _{(BR)DSS}	I _D =1mA V _{GS} =0V	30			V	
Gate threshold voltage	V _{GS(th)}	I _D =1mA V _{DS} =V _{GS}	1.0	1.5	2.0	V	
Zero gate voltage drain current	I _{DSS}	V _{DS} =30V V _{GS} =0V	T _{ch} =25°C		10	500	μA
			T _{ch} =125°C		0.2	1.0	mA
Gate-source leakage current	I _{GSS}	V _{GS} =±16V V _{DS} =0V		10	100	nA	
Drain-source on-state resistance	R _{DS(on)}	I _D =17.5A V _{GS} =10V	V _{GS} =4V		22	30	mΩ
			V _{GS} =10V		14	20	mΩ
Forward transconductance	g _{fs}	I _D =17.5A V _{DS} =25V	16	33		S	
Input capacitance	C _{iss}	V _{DS} =25V V _{GS} =0V f=1MHz		1100	1650	pF	
Output capacitance	C _{oss}			550	830		
Reverse transfer capacitance	C _{rss}			240	360		
Turn-on time	t _{d(on)}	V _{CC} =15V R _G =10 Ω I _D =35A V _{GS} =10V		9	15	ns	
	t _r			15	23		
Turn-off time	t _{d(off)}			75	115		
	t _f			50	75		
Avalanche capability	I _{AV}	L=100μH T _{ch} =25°C	35			A	
Diode forward on-voltage	V _{SD}	I _F =2I _{DR} V _{GS} =0V T _{ch} =25°C		0.98	1.71	V	
Reverse recovery time	t _{rr}	I _F =2I _{DR} V _{GS} =0V		50		ns	
Reverse recovery charge	Q _{rr}	-di/dt=100A/μs T _{ch} =25°C		0.08		μC	

● Thermal characteristics

Item	Symbol	Min.	Typ.	Max.	Units
Thermal resistance	R _{th(ch-c)}			4.16	°C/W
	R _{th(ch-a)}			75.0	°C/W

Characteristics

Allowable Power Dissipation vs. T_{ch}
PD=f(T_{ch})

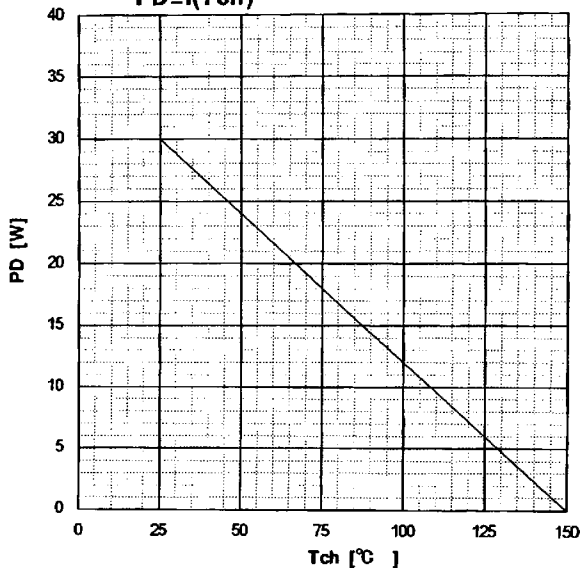

Safe operating area
ID=f(V_{DS}):D=0.01,T_c=25°C

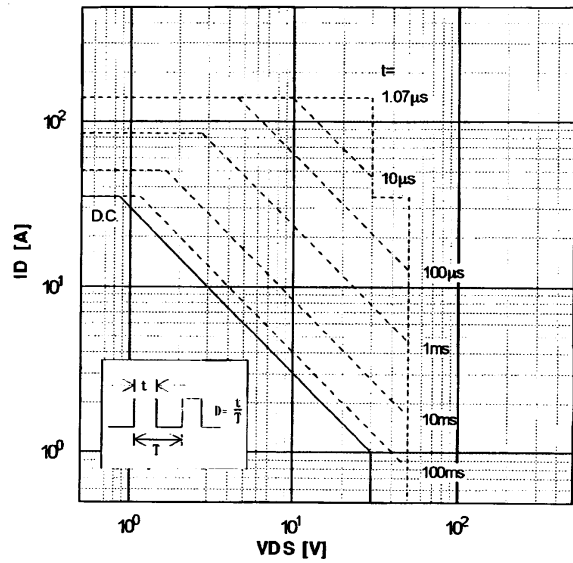

Typical Output Characteristics
ID=f(V_{DS}):80 μs pulse test,T_{ch}=25°C

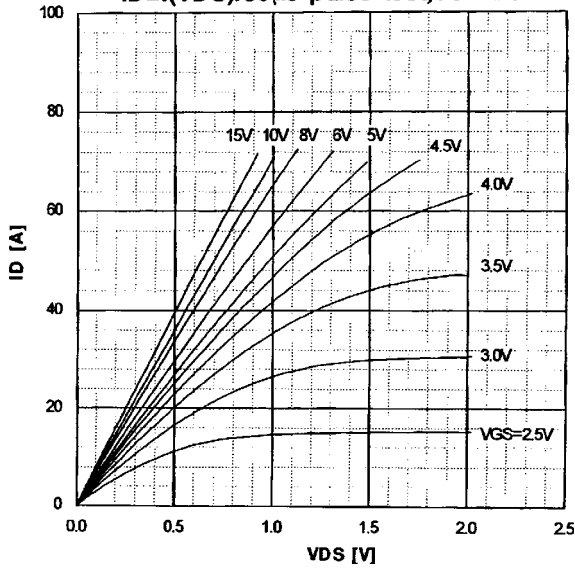

Typical Transfer Characteristic
ID=f(V_{GS}):80 μs pulse test,V_{DS}=25V,T_{ch}=25°C

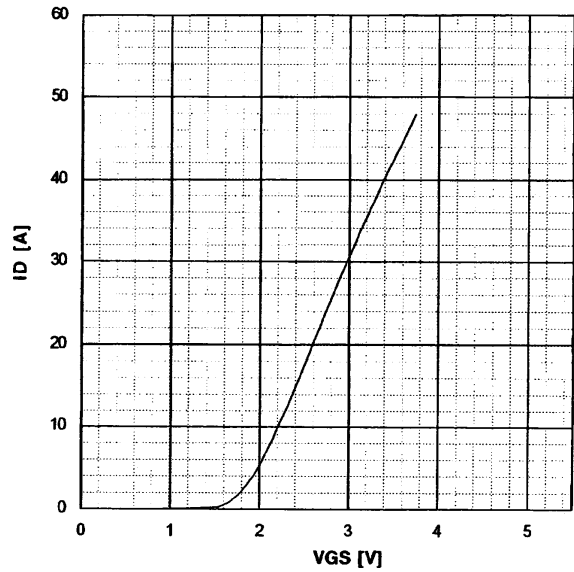

Typical Transconductance
g_{fs}=f(ID):80 μs pulse test,V_{DS}=25V,T_{ch}=25°C

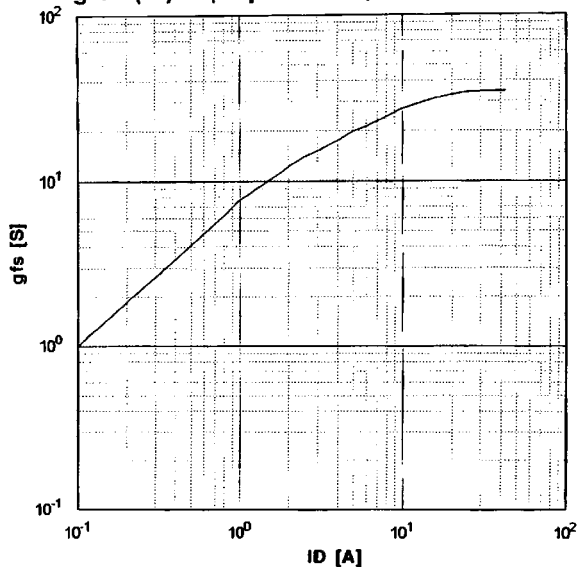

Typical Drain-Source on-state Resistance vs. ID
R_{DS(on)}=f(ID):80 μs pulse test,T_{ch}=25°C

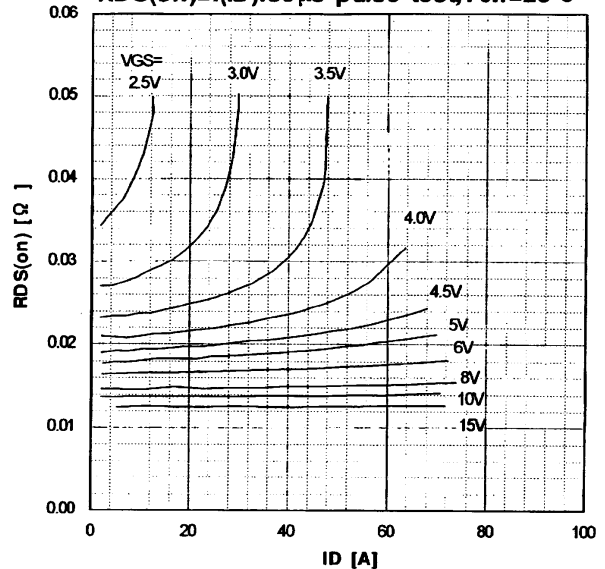

Drain-Source On-state Resistance vs. T_{ch}
 $R_{DS(on)}=f(T_{ch}):I_D=17.5A, V_{GS}=10V$

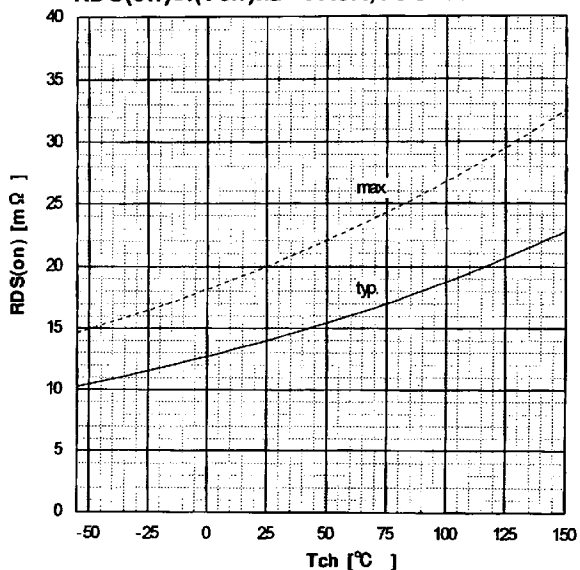

Gate Threshold Voltage vs. T_{ch}
 $V_{GS(th)}=f(T_{ch}):V_{DS}=V_{GS}, I_D=1mA$

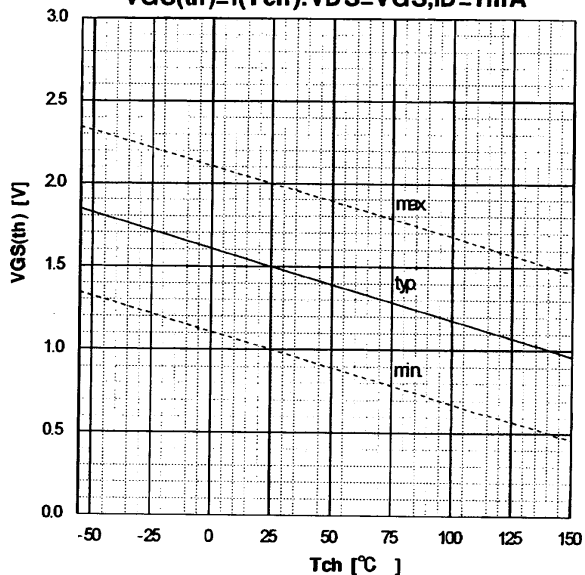

Typical Capacitances vs. V_{DS}
 $C=f(V_{DS}):V_{GS}=0V, f=1MHz$

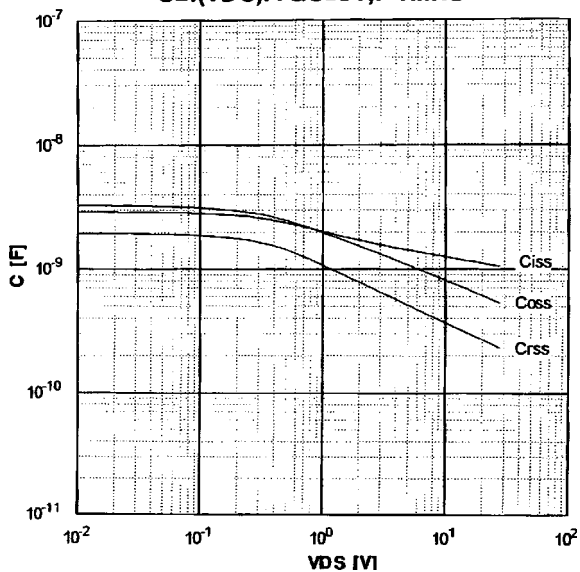

Typical Gate Charge Characteristics
 $V_{GS}=f(Q_g):I_D=35A, T_{ch}=25°C$

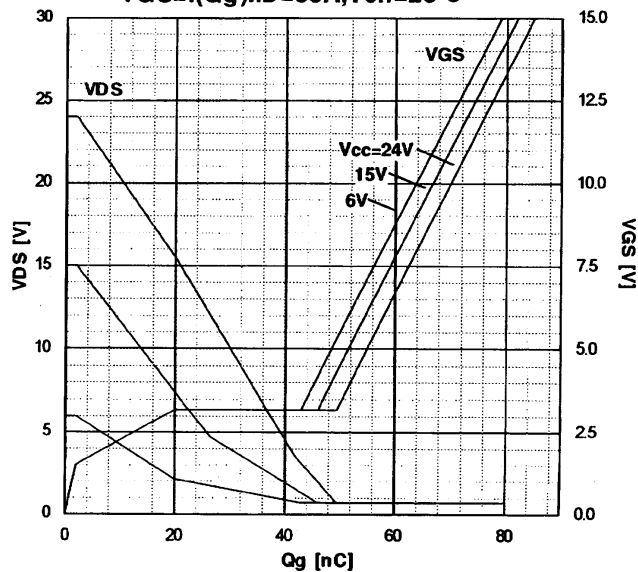

Typical Forward Characteristics of Reverse Diode
 $I_F=f(V_{SD}):80\mu s \text{ pulse test}, T_{ch}=25°C$

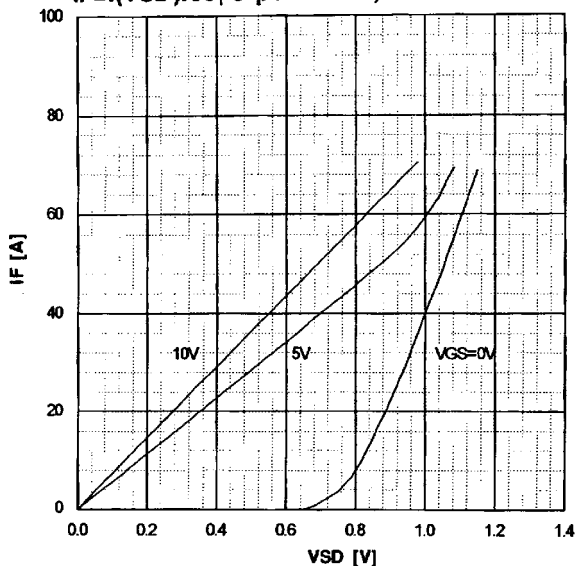

Typical Switching Characteristics vs. I_D
 $t=f(I_D):V_{CC}=15V, V_{GS}=10V, R_G=10\Omega$

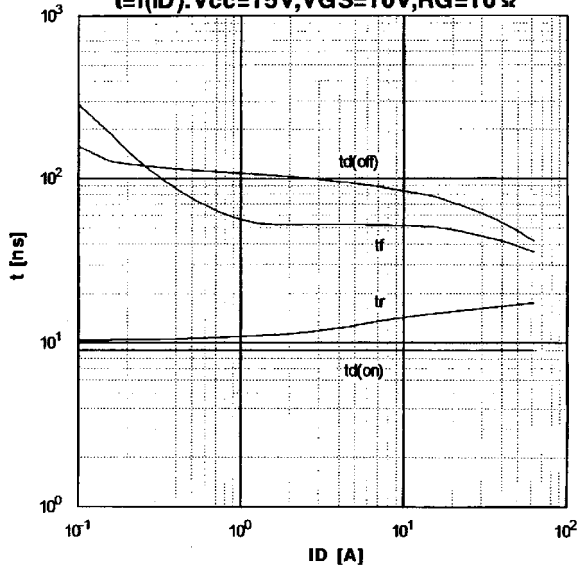

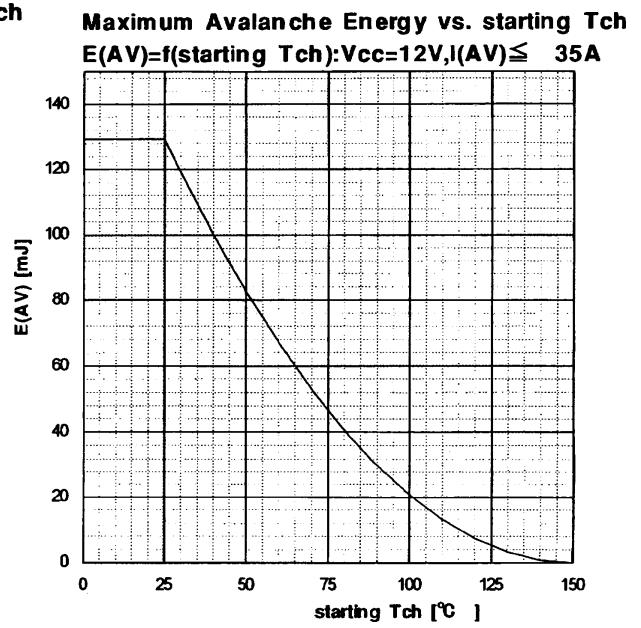
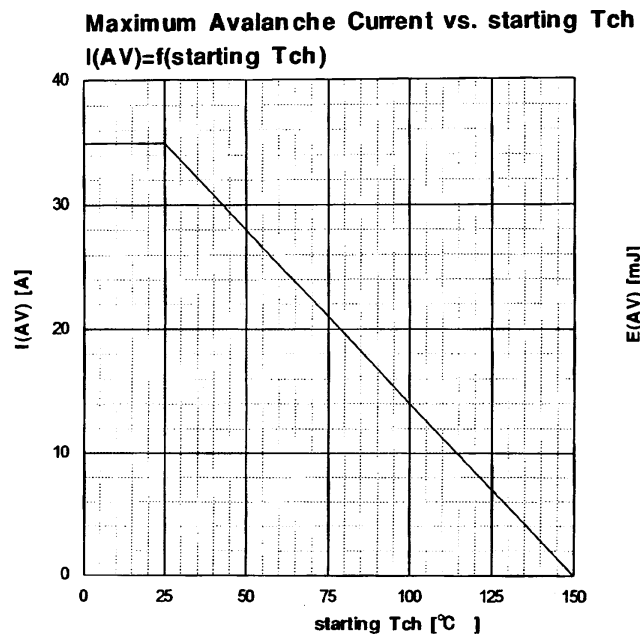

Transient Thermal Impedance
 $Z_{th}(ch-c)=f(t): \text{parameter } D=t/T$

