

AOD404
N-Channel Enhancement Mode Field Effect Transistor
General Description

The AOD404 uses advanced trench technology to provide excellent $R_{DS(ON)}$, low gate charge and low gate resistance. This device is ideally suited for use as a high side switch in CPU core power conversion.

- RoHS Compliant
- Halogen Free*

Features

- V_{DS} (V) = 30V
- I_D = 85A (V_{GS} = 10V)
- $R_{DS(ON)} < 7m\Omega$ (V_{GS} = 10V)
- $R_{DS(ON)} < 8m\Omega$ (V_{GS} = 4.5V)

UIS TESTED!
Rg, Ciss, Coss, Crss Tested

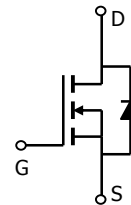
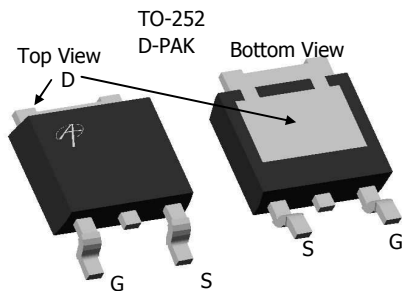
Absolute Maximum Ratings $T_A=25^\circ\text{C}$ unless otherwise noted

Parameter	Symbol	Maximum	Units
Drain-Source Voltage	V_{DS}	30	V
Gate-Source Voltage	V_{GS}	± 12	V
Continuous Drain Current ^{B,G}	I_D	$T_C=25^\circ\text{C}^G$	85
		$T_C=100^\circ\text{C}^B$	65
Pulsed Drain Current	I_{DM}	200	A
Avalanche Current ^C	I_{AR}	30	A
Repetitive avalanche energy $L=0.1\text{mH}^C$	E_{AR}	120	mJ
Power Dissipation ^B	P_D	$T_C=25^\circ\text{C}$	100
		$T_C=100^\circ\text{C}$	50
Power Dissipation ^A	P_{DSM}	$T_A=25^\circ\text{C}$	2.5
		$T_A=70^\circ\text{C}$	1.6
Junction and Storage Temperature Range	T_J, T_{STG}	-55 to 175	$^\circ\text{C}$

Thermal Characteristics

Parameter	Symbol	Typ	Max	Units
Maximum Junction-to-Ambient ^A	$R_{\theta JA}$	$t \leq 10\text{s}$	14.2	$^\circ\text{C/W}$
Maximum Junction-to-Ambient ^A		Steady-State	39	$^\circ\text{C/W}$
Maximum Junction-to-Case ^C	$R_{\theta JL}$	0.8	1.5	$^\circ\text{C/W}$

Electrical Characteristics ($T_J=25^\circ\text{C}$ unless otherwise noted)

Symbol	Parameter	Conditions	Min	Typ	Max	Units
STATIC PARAMETERS						
BV_{DSS}	Drain-Source Breakdown Voltage	$I_D=250\mu\text{A}, V_{GS}=0\text{V}$	30			V
I_{DSS}	Zero Gate Voltage Drain Current	$V_{DS}=30\text{V}, V_{GS}=0\text{V}$ $T_J=55^\circ\text{C}$			1 5	μA
I_{GSS}	Gate-Body leakage current	$V_{DS}=0\text{V}, V_{GS}=\pm 12\text{V}$			100	nA
$V_{GS(th)}$	Gate Threshold Voltage	$V_{DS}=V_{GS}, I_D=250\mu\text{A}$	1	1.6	2	V
$I_{D(ON)}$	On state drain current	$V_{GS}=10\text{V}, V_{DS}=5\text{V}$	85			A
$R_{DS(ON)}$	Static Drain-Source On-Resistance	$V_{GS}=10\text{V}, I_D=20\text{A}$ $T_J=125^\circ\text{C}$		5.4 8.4	7 10.5	$\text{m}\Omega$
		$V_{GS}=4.5\text{V}, I_D=20\text{A}$		6.6	8	$\text{m}\Omega$
g_{FS}	Forward Transconductance	$V_{DS}=5\text{V}, I_D=20\text{A}$		90		S
V_{SD}	Diode Forward Voltage	$I_S=1\text{A}, V_{GS}=0\text{V}$		0.74	1	V
I_S	Maximum Body-Diode Continuous Current				85	A
DYNAMIC PARAMETERS						
C_{iss}	Input Capacitance	$V_{GS}=0\text{V}, V_{DS}=15\text{V}, f=1\text{MHz}$		2100	2520	pF
C_{oss}	Output Capacitance			536		pF
C_{rss}	Reverse Transfer Capacitance			165	231	pF
R_g	Gate resistance	$V_{GS}=0\text{V}, V_{DS}=0\text{V}, f=1\text{MHz}$	0.5	0.95	1.2	Ω
SWITCHING PARAMETERS						
$Q_g(4.5\text{V})$	Total Gate Charge	$V_{GS}=4.5\text{V}, V_{DS}=15\text{V}, I_D=20\text{A}$		19.7	24	nC
Q_{gs}	Gate Source Charge			3.6		nC
Q_{gd}	Gate Drain Charge			7.9		nC
$t_{D(on)}$	Turn-On Delay Time	$V_{GS}=10\text{V}, V_{DS}=15\text{V}, R_L=0.75\Omega,$ $R_{GEN}=3\Omega$		5.9	10	ns
t_r	Turn-On Rise Time			11	17	ns
$t_{D(off)}$	Turn-Off Delay Time			36.2	55	ns
t_f	Turn-Off Fall Time			12	18	ns
t_{rr}	Body Diode Reverse Recovery Time	$I_F=20\text{A}, dI/dt=100\text{A}/\mu\text{s}$		35	42	ns
Q_{rr}	Body Diode Reverse Recovery Charge	$I_F=20\text{A}, dI/dt=100\text{A}/\mu\text{s}$		33	50	nC

A: The value of $R_{\theta JA}$ is measured with the device mounted on 1in^2 FR-4 board with 2oz. Copper, in a still air environment with $T_A=25^\circ\text{C}$. The Power dissipation P_{DSM} is based on steady-state $R_{\theta JA}$ and the maximum allowed junction temperature of 150°C . The value in any a given application depends on the user's specific board design, and the maximum temperature fo 175°C may be used if the PCB or heatsink allows it.

B: The power dissipation P_D is based on $T_{J(MAX)}=175^\circ\text{C}$, using junction-to-case thermal resistance, and is more useful in setting the upper dissipation limit for cases where additional heatsinking is used. It is used to determine the current rating, when this rating falls below the package limit.

C: Repetitive rating, pulse width limited by junction temperature $T_{J(MAX)}=175^\circ\text{C}$.

D: The $R_{\theta JA}$ is the sum of the thermal impedance from junction to case $R_{\theta JC}$ and case to ambient.

E: The static characteristics in Figures 1 to 6 are obtained using $<300\ \mu\text{s}$ pulses, duty cycle 0.5% max.

F: These tests are performed with the device mounted on 1in^2 FR-4 board with 2oz. Copper, in a still air environment with $T_A=25^\circ\text{C}$. The SOA curve provides a single pulse rating.

G: The maximum current rating is limited by the package current capability.

*This device is guaranteed green after data code 8X11 (Sep 1ST 2008).

Rev 8: Sep 2008

THIS PRODUCT HAS BEEN DESIGNED AND QUALIFIED FOR THE CONSUMER MARKET. APPLICATIONS OR USES AS CRITICAL COMPONENTS IN LIFE SUPPORT DEVICES OR SYSTEMS ARE NOT AUTHORIZED. AOS DOES NOT ASSUME ANY LIABILITY ARISING OUT OF SUCH APPLICATIONS OR USES OF ITS PRODUCTS. AOS RESERVES THE RIGHT TO IMPROVE PRODUCT DESIGN, FUNCTIONS AND RELIABILITY WITHOUT NOTICE

TYPICAL ELECTRICAL AND THERMAL CHARACTERISTICS

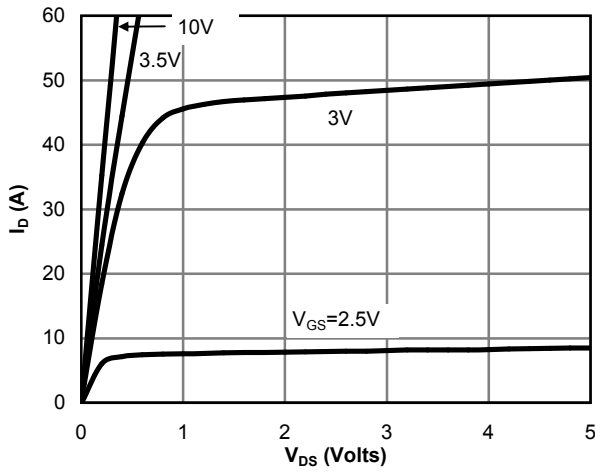

Fig 1: On-Region Characteristics

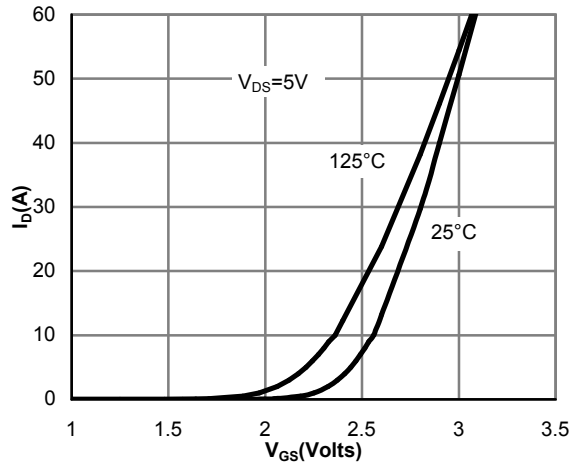

Figure 2: Transfer Characteristics

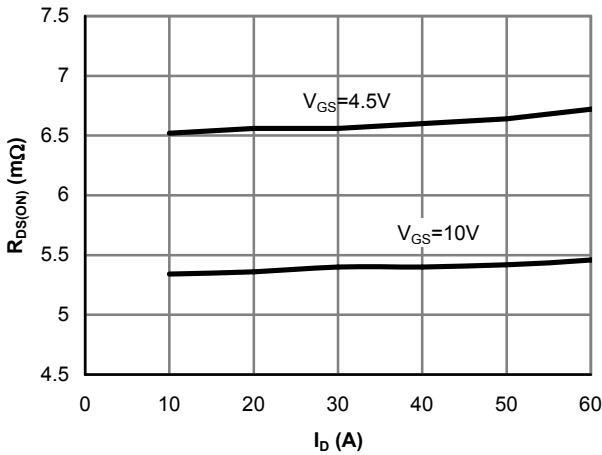

Figure 3: On-Resistance vs. Drain Current and Gate Voltage

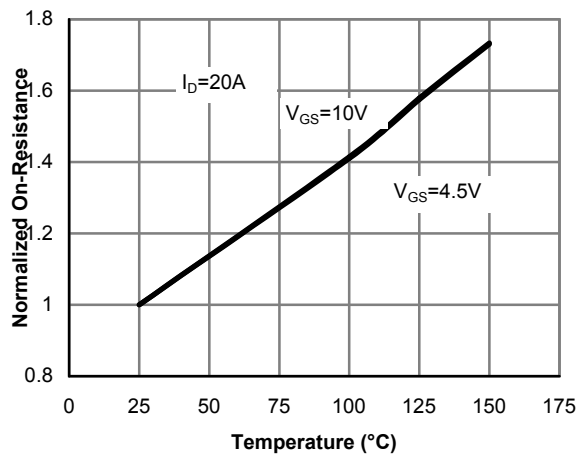

Figure 4: On-Resistance vs. Junction Temperature

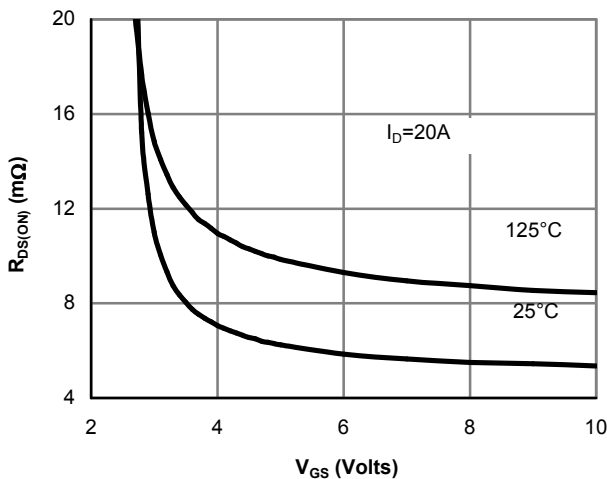

Figure 5: On-Resistance vs. Gate-Source Voltage

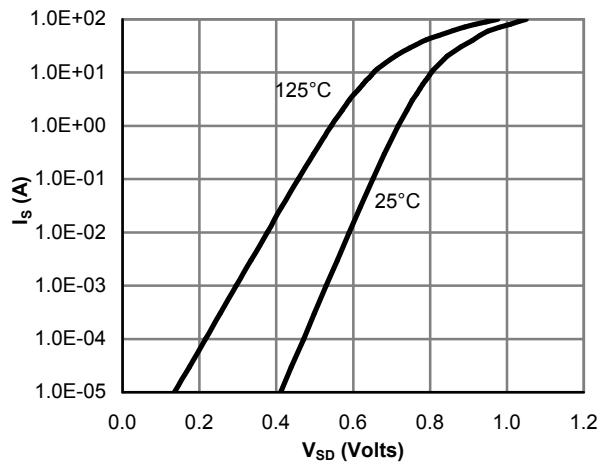

Figure 6: Body-Diode Characteristics

TYPICAL ELECTRICAL AND THERMAL CHARACTERISTICS

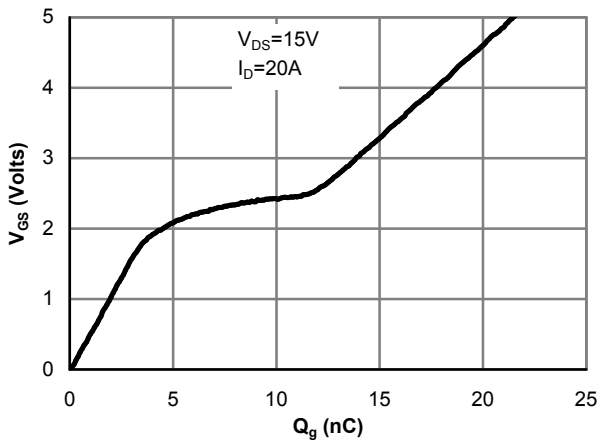

Figure 7: Gate-Charge Characteristics

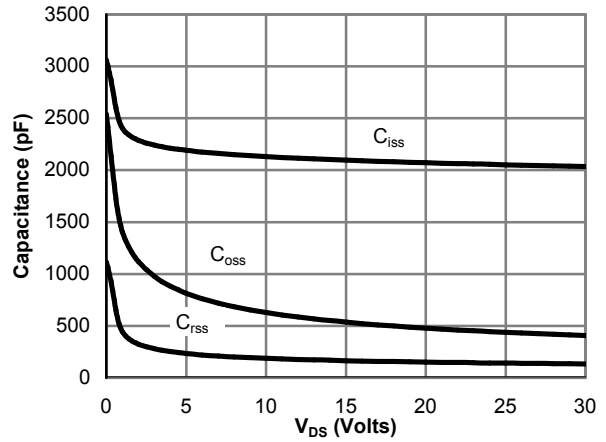

Figure 8: Capacitance Characteristics

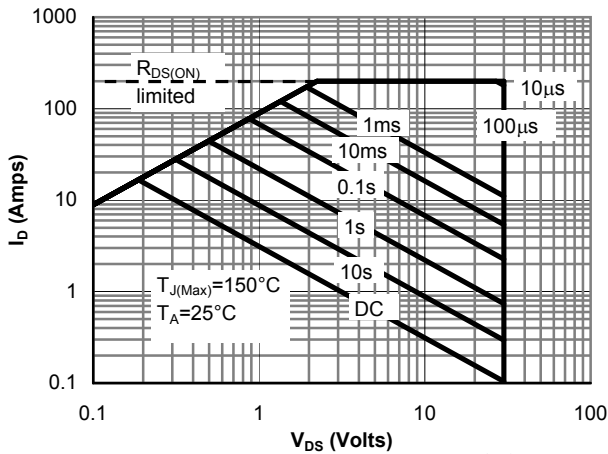

Figure 9: Maximum Forward Biased Safe Operating Area (Note F)

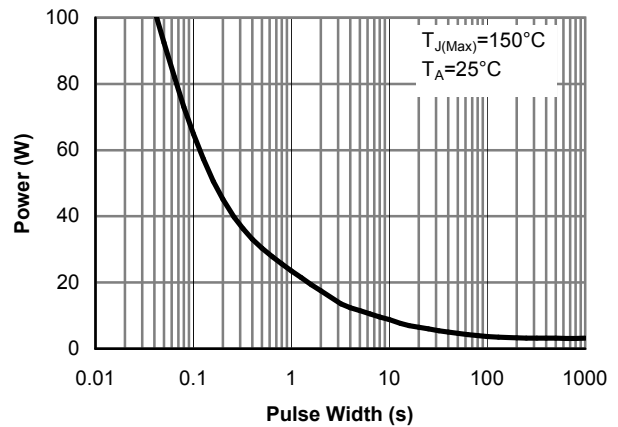

Figure 10: Single Pulse Power Rating Junction-to-Ambient (Note F)

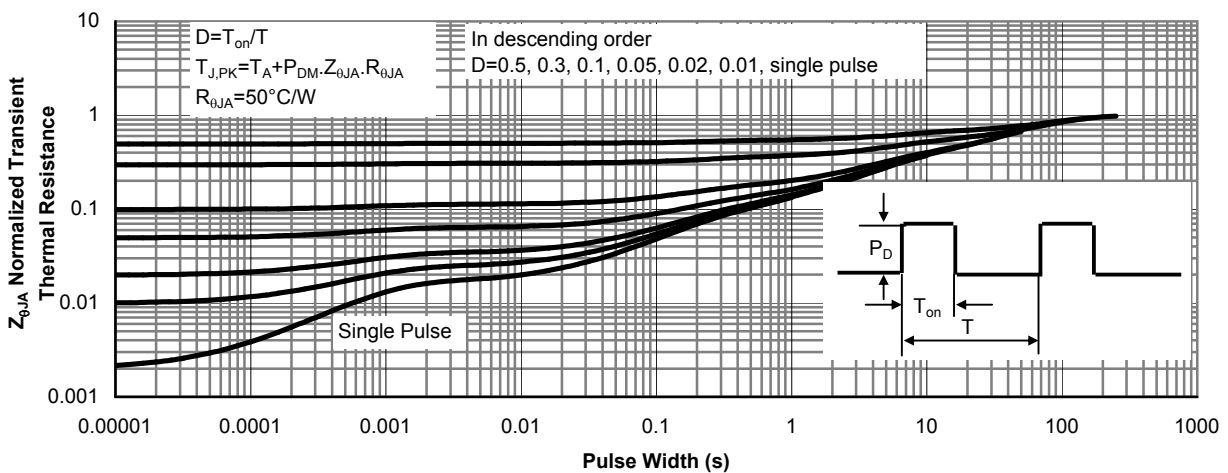
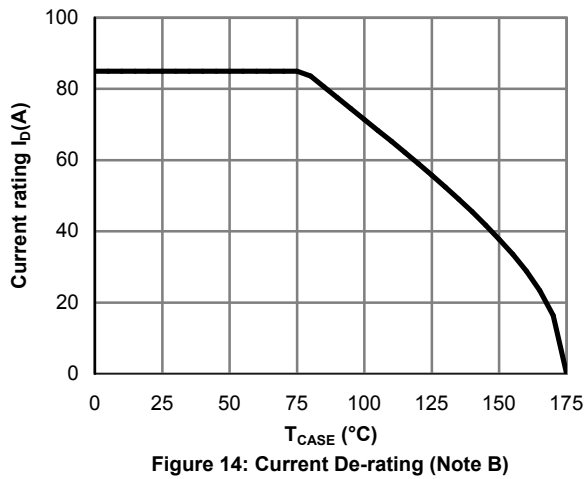
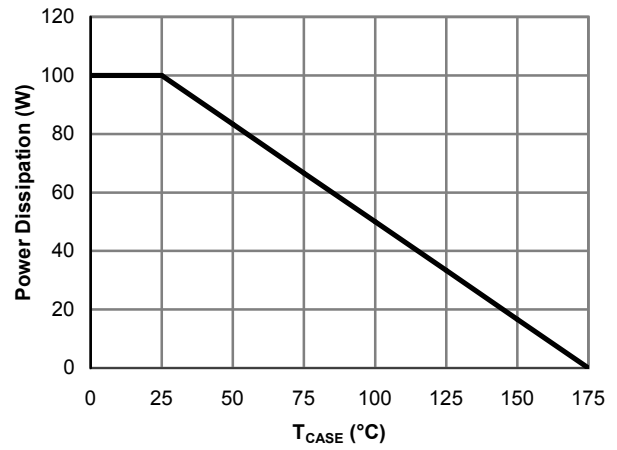
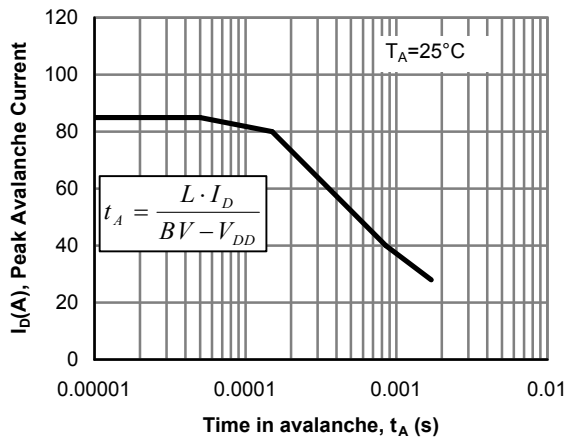
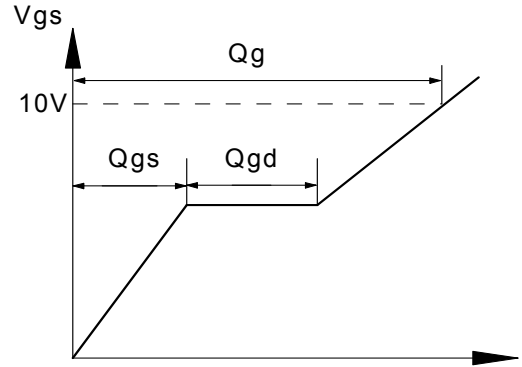
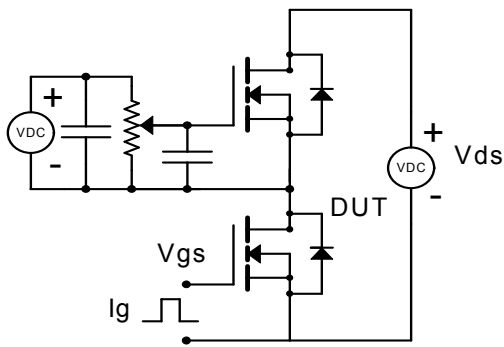

Figure 11: Normalized Maximum Transient Thermal Impedance (Note F)

TYPICAL ELECTRICAL AND THERMAL CHARACTERISTICS



Gate Charge Test Circuit & Waveform



Resistive Switching Test Circuit & Waveforms

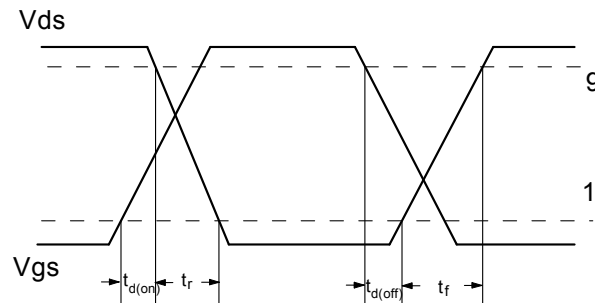
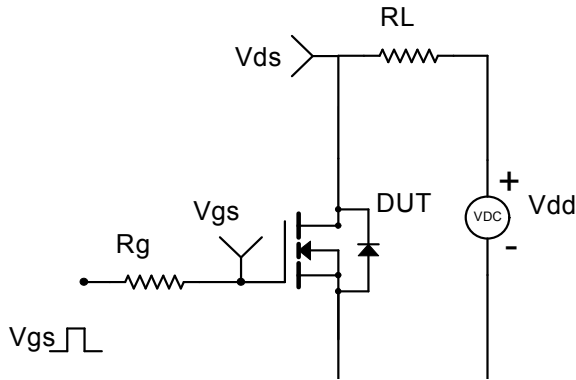

Unclamped Inductive Switching (UIS) Test Circuit & Waveforms

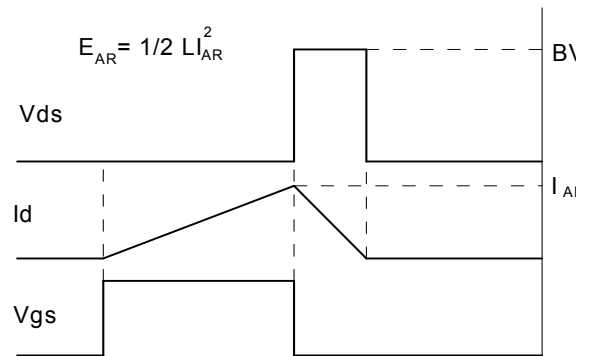
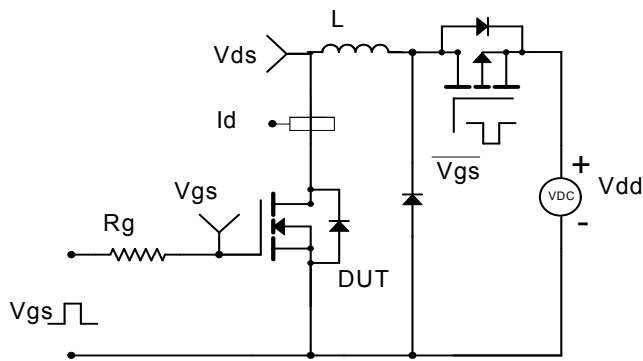

Diode Recovery Test Circuit & Waveforms

