

AO4418
N-Channel Enhancement Mode Field Effect Transistor

General Description

The AO4418 uses advanced trench technology to provide excellent $R_{DS(ON)}$ and low gate charge. This device is suitable for use as a load switch or in PWM applications.

Standard Product AO4418 is Pb-free (meets ROHS & Sony 259 specifications).

Features

$V_{DS} (V) = 30V$
 $I_D = 11.5A (V_{GS} = 20V)$
 $R_{DS(ON)} < 14m\Omega (V_{GS} = 20V)$
 $R_{DS(ON)} < 17m\Omega (V_{GS} = 10V)$
 $R_{DS(ON)} < 40m\Omega (V_{GS} = 4.5V)$

UIS TESTED!
Rg, Ciss, Coss, Crss Tested

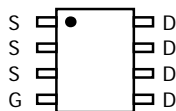
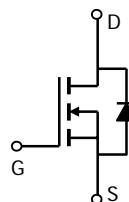
SOIC-8

Absolute Maximum Ratings $T_A=25^\circ C$ unless otherwise noted

Parameter	Symbol	Maximum	Units
Drain-Source Voltage	V_{DS}	30	V
Gate-Source Voltage	V_{GS}	± 25	V
Continuous Drain Current ^{AF}	I_D	$T_A=25^\circ C$	A
		$T_A=70^\circ C$	
Pulsed Drain Current ^B	I_{DM}	40	
Power Dissipation	P_D	$T_A=25^\circ C$	W
		$T_A=70^\circ C$	
Avalanche Current ^B	I_{AR}	20	A
Repetitive avalanche energy 0.3mH ^B	E_{AR}	60	mJ
Junction and Storage Temperature Range	T_J, T_{STG}	-55 to 150	$^\circ C$

Thermal Characteristics

Parameter	Symbol	Typ	Max	Units
Maximum Junction-to-Ambient ^{AF}	$R_{\theta JA}$	31	40	$^\circ C/W$
Maximum Junction-to-Ambient ^A		Steady-State	59	75
Maximum Junction-to-Lead ^C	$R_{\theta JL}$	16	24	$^\circ C/W$

Electrical Characteristics (T_J=25°C unless otherwise noted)

Symbol	Parameter	Conditions	Min	Typ	Max	Units
STATIC PARAMETERS						
BV _{DSS}	Drain-Source Breakdown Voltage	I _D =250μA, V _{GS} =0V	30			V
I _{DSS}	Zero Gate Voltage Drain Current	V _{DS} =30V, V _{GS} =0V T _J =55°C			1 5	μA
I _{GSS}	Gate-Body leakage current	V _{DS} =0V, V _{GS} = ±25V			100	nA
V _{GS(th)}	Gate Threshold Voltage	V _{DS} =V _{GS} , I _D =250μA	1.5	2.4	3	V
I _{D(ON)}	On state drain current	V _{GS} =10V, V _{DS} =5V	40			A
R _{DS(ON)}	Static Drain-Source On-Resistance	V _{GS} =20V, I _D =11.5A T _J =125°C		9.8 14.2	14 18	mΩ
		V _{GS} =10V, I _D =10A		12.3	17	mΩ
		V _{GS} =4.5V, I _D =5A		32	40	mΩ
g _{FS}	Forward Transconductance	V _{DS} =5V, I _D =10A	14	22		S
V _{SD}	Diode Forward Voltage	I _S =1A, V _{GS} =0V		0.76	1	V
I _S	Maximum Body-Diode Continuous Current				4.3	A
DYNAMIC PARAMETERS						
C _{iss}	Input Capacitance	V _{GS} =0V, V _{DS} =15V, f=1MHz		758	910	pF
C _{oss}	Output Capacitance			180		pF
C _{rss}	Reverse Transfer Capacitance			128	180	pF
R _g	Gate resistance	V _{GS} =0V, V _{DS} =0V, f=1MHz	0.3	0.7	1.1	Ω
SWITCHING PARAMETERS						
Q _g (10V)	Total Gate Charge	V _{GS} =10V, V _{DS} =15V, I _D =11.5A		16.6	20	nC
Q _g (4.5V)	Total Gate Charge			8.6		nC
Q _{gs}	Gate Source Charge			2.5		nC
Q _{gd}	Gate Drain Charge			4.9		nC
t _{D(on)}	Turn-On Delay Time	V _{GS} =10V, V _{DS} =15V, R _L =1.3Ω, R _{GEN} =3Ω		5.4		ns
t _r	Turn-On Rise Time			5.1		ns
t _{D(off)}	Turn-Off Delay Time			14.4		ns
t _f	Turn-Off Fall Time			3.7		ns
t _{rr}	Body Diode Reverse Recovery Time	I _F =11.5A, dI/dt=100A/μs		16.9	22	ns
Q _{rr}	Body Diode Reverse Recovery Charge	I _F =11.5A, dI/dt=100A/μs		6.6		nC

A: The value of R_{θJA} is measured with the device mounted on 1in² FR-4 board with 2oz. Copper, in a still air environment with T_A=25°C. The value in any given application depends on the user's specific board design.

B: Repetitive rating, pulse width limited by junction temperature.

C. The R_{θJA} is the sum of the thermal impedance from junction to lead R_{θJL} and lead to ambient.

D. The static characteristics in Figures 1 to 6 are obtained using <300μs pulses, duty cycle 0.5% max.

E. These tests are performed with the device mounted on 1 in² FR-4 board with 2oz. Copper, in a still air environment with T_A=25°C. The SOA curve provides a single pulse rating.

F. The current rating is based on the t ≤ 10s thermal resistance rating.

Rev 6: July 2007

THIS PRODUCT HAS BEEN DESIGNED AND QUALIFIED FOR THE CONSUMER MARKET. APPLICATIONS OR USES AS CRITICAL COMPONENTS IN LIFE SUPPORT DEVICES OR SYSTEMS ARE NOT AUTHORIZED. AOS DOES NOT ASSUME ANY LIABILITY ARISING OUT OF SUCH APPLICATIONS OR USES OF ITS PRODUCTS. AOS RESERVES THE RIGHT TO IMPROVE PRODUCT DESIGN, FUNCTIONS AND RELIABILITY WITHOUT NOTICE.

TYPICAL ELECTRICAL AND THERMAL CHARACTERISTICS

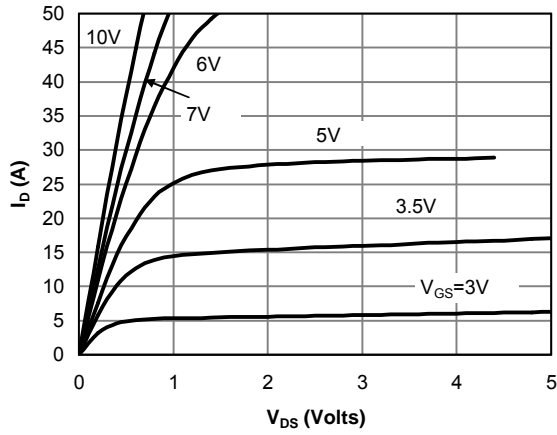

Fig 1: On-Region Characteristics

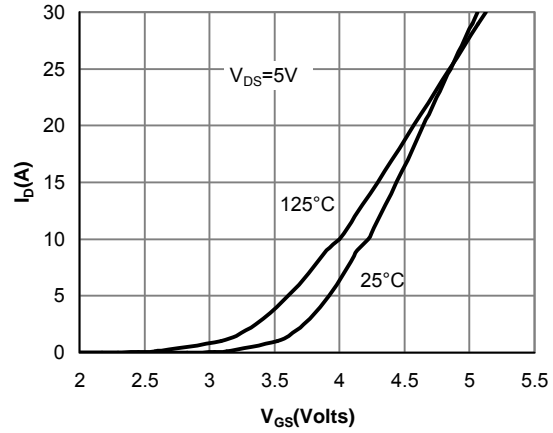

Figure 2: Transfer Characteristics

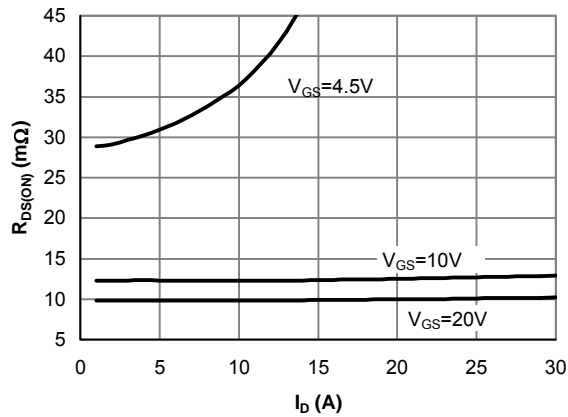

Figure 3: On-Resistance vs. Drain Current and Gate Voltage

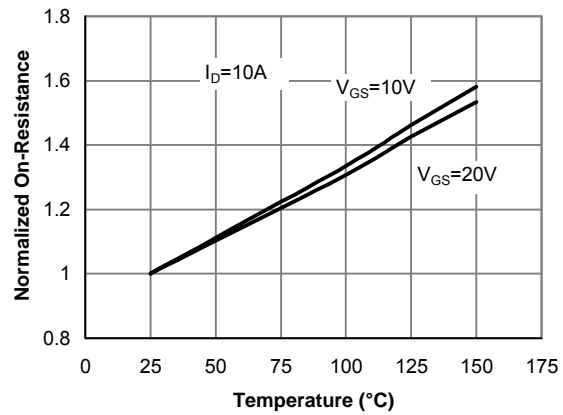

Figure 4: On-Resistance vs. Junction Temperature

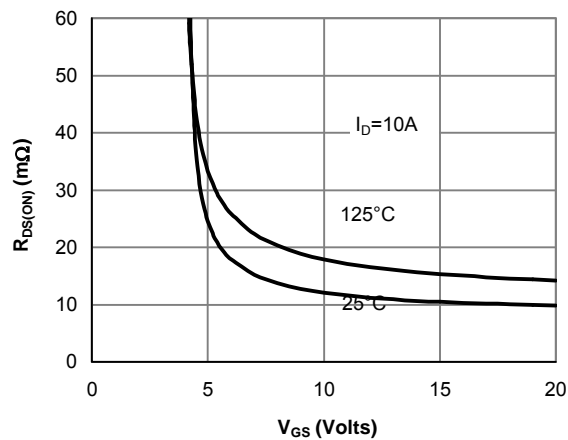

Figure 5: On-Resistance vs. Gate-Source Voltage

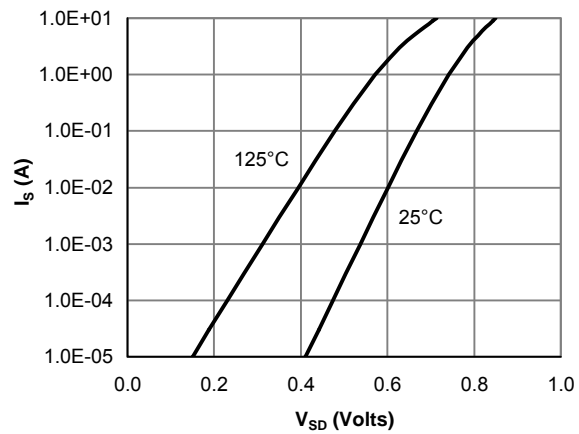

Figure 6: Body-Diode Characteristics

TYPICAL ELECTRICAL AND THERMAL CHARACTERISTICS

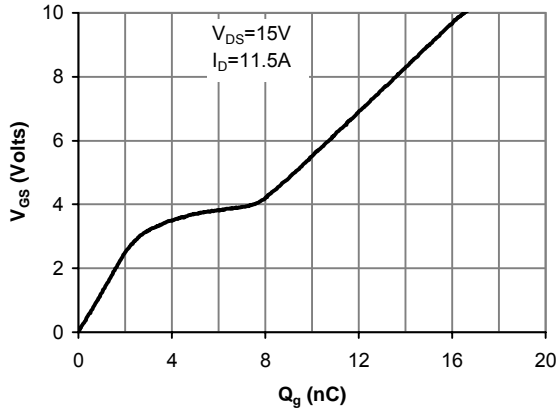

Figure 7: Gate-Charge Characteristics

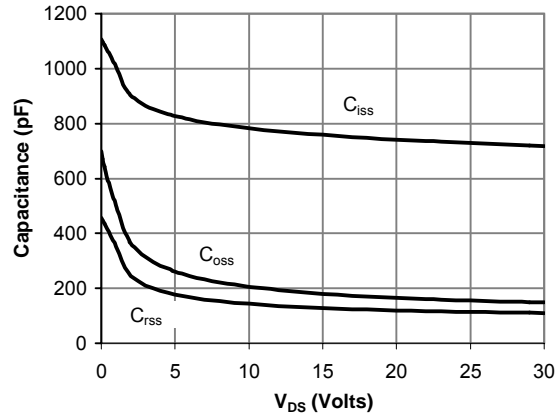

Figure 8: Capacitance Characteristics

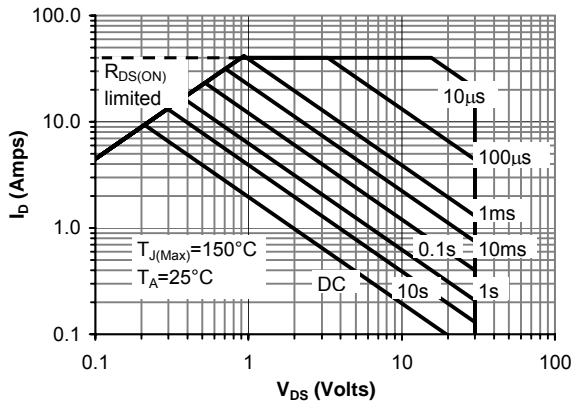

Figure 9: Maximum Forward Biased Safe Operating Area (Note E)

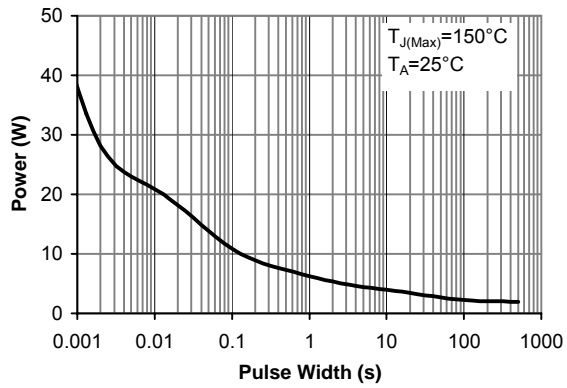

Figure 10: Single Pulse Power Rating Junction-to-Ambient (Note E)

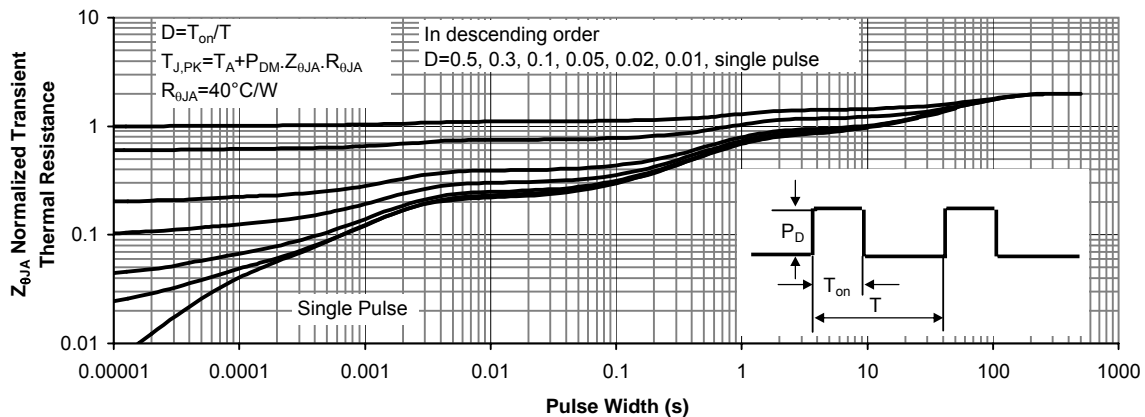
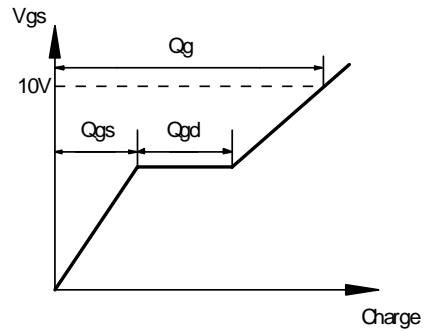
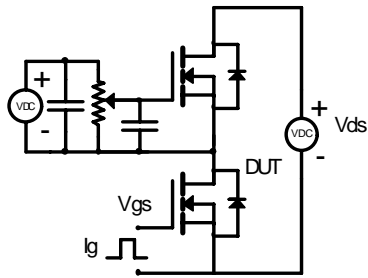
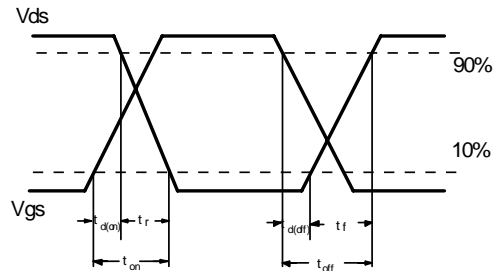
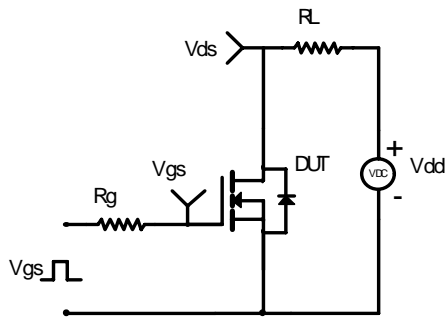

Figure 11: Normalized Maximum Transient Thermal Impedance

Gate Charge Test Circuit & Waveform



Resistive Switching Test Circuit & Waveforms



Unclamped Inductive Switching (UIS) Test Circuit & Waveforms

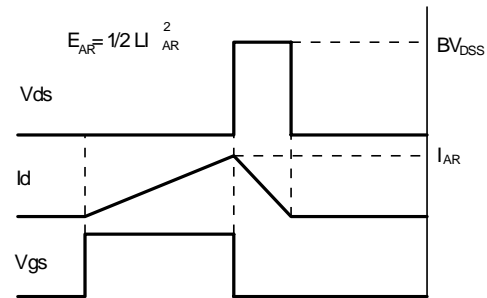
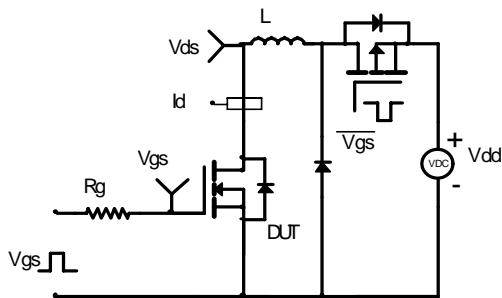

Diode Recovery Test Circuit & Waveforms

