

EPC1005 – Enhancement Mode Power Transistor

 $V_{DS}, 60\text{ V}$
 $R_{DS(ON)}, 7\text{ m}\Omega$
 $I_D, 25\text{ A}$

Gallium Nitride is grown on Silicon Wafers and processed using standard CMOS equipment leveraging the infrastructure that has been developed over the last 55 years. GaN's exceptionally high electron mobility and low temperature coefficient allows very low $R_{DS(ON)}$, while its lateral device structure and majority carrier diode provide exceptionally low Q_G and zero Q_{RR} . The end result is a device that can handle tasks where very high switching frequency, and low on-time are beneficial as well as those where on-state losses dominate.

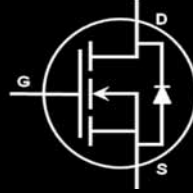

EPC Power Transistors are supplied only in passivated die form with solder bumps

Applications

- High Speed DC-DC conversion
- Class D Audio
- Hard Switched and High Frequency Circuits

Benefits

- Ultra High Efficiency
- Ultra Low $R_{DS(on)}$
- Ultra low Q_G
- Ultra small footprint

Maximum Ratings			
V_{DS}	Drain-to-Source Voltage	60	V
I_D	Continuous ($T_A = 25^\circ\text{C}$, $\theta_{JA} = 20$)	25	A
	Pulsed (25°C , $T_{pulse} = 300\ \mu\text{s}$)	100	
V_{GS}	Gate-to-Source Voltage	6	V
	Gate-to-Source Voltage	-5	
T_J	Operating Temperature	-40 to 125	$^\circ\text{C}$
T_{STG}	Storage Temperature	-40 to 150	

PARAMETER	TEST CONDITIONS	MIN	TYP	MAX	UNIT	
Static Characteristics ($T_J = 25^\circ\text{C}$ unless otherwise stated)						
BV_{DSS}	Drain-to-Source Voltage	$V_{GS} = 0\text{ V}, I_D = 300\ \mu\text{A}$	60		V	
I_{DSS}	Drain Source Leakage	$V_{DS} = 48\text{ V}, V_{GS} = 0\text{ V}$		50	250	μA
I_{GSS}	Gate-Source Forward Leakage	$V_{GS} = 5\text{ V}$		1	5	mA
	Gate-Source Reverse Leakage	$V_{GS} = -5\text{ V}$		0.2	1	
$V_{GS(th)}$	Gate Threshold Voltage	$V_{DS} = V_{GS}, I_D = 5\text{ mA}$	0.7	1.4	2.5	V
$R_{DS(ON)}$	Drain-Source On Resistance	$V_{GS} = 5\text{ V}, I_D = 25\text{ A}$		5.6	7	$\text{m}\Omega$
Dynamic Characteristics ($T_J = 25^\circ\text{C}$ unless otherwise stated)						
C_{ISS}	Input Capacitance	$V_{DS} = 30\text{ V}, V_{GS} = 0\text{ V}$		790		pF
C_{OSS}	Output Capacitance			480		
C_{RSS}	Reverse Transfer Capacitance			43		
Q_G	Total Gate Charge ($V_{GS} = 5\text{ V}$)	$V_{DS} = 30\text{ V}, I_D = 25\text{ A}$		10		nC
Q_{GD}	Gate to Drain Charge			2.5		
Q_{GS}	Gate to Source Charge			3		
Q_{OSS}	Output Charge			23		
Q_{RR}	Source-Drain Recovery Charge			0		
Source-Drain Characteristics ($T_J = 25^\circ\text{C}$ unless otherwise stated)						
V_{SD}	Source-Drain Forward Voltage	$I_S = 0.5\text{ A}, V_{GS} = 0\text{ V}, T = 25^\circ\text{C}$		1.8		V
		$I_S = 0.5\text{ A}, V_{GS} = 0\text{ V}, T = 125^\circ\text{C}$		1.75		

Figure 1: Typical Output Characteristics

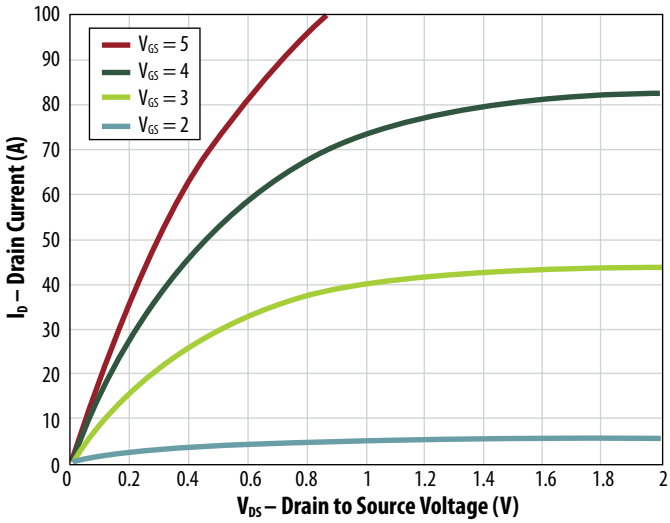

Figure 2: Transfer Characteristics

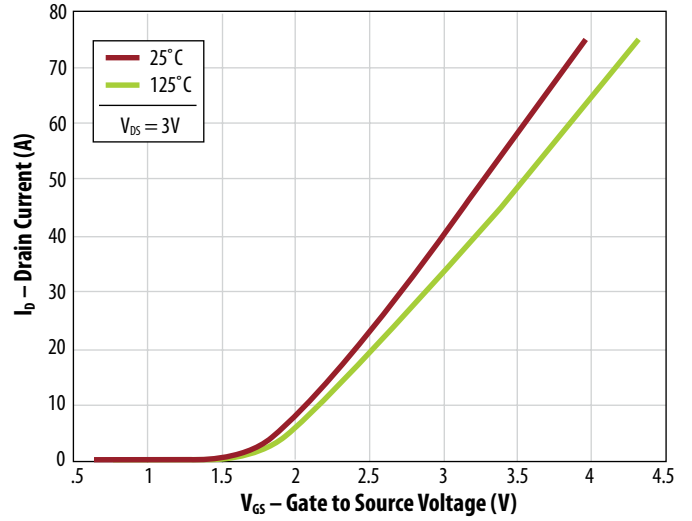

Figure 3: $R_{DS(ON)}$ vs V_G for Various Current

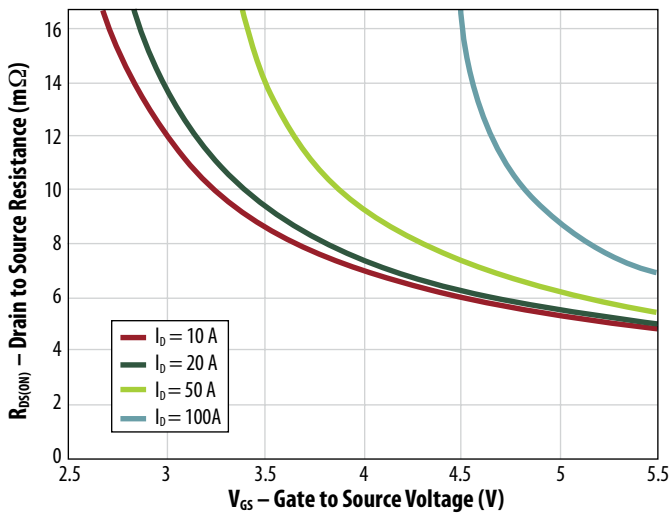

Figure 4: $R_{DS(ON)}$ vs V_G for Various Temperature

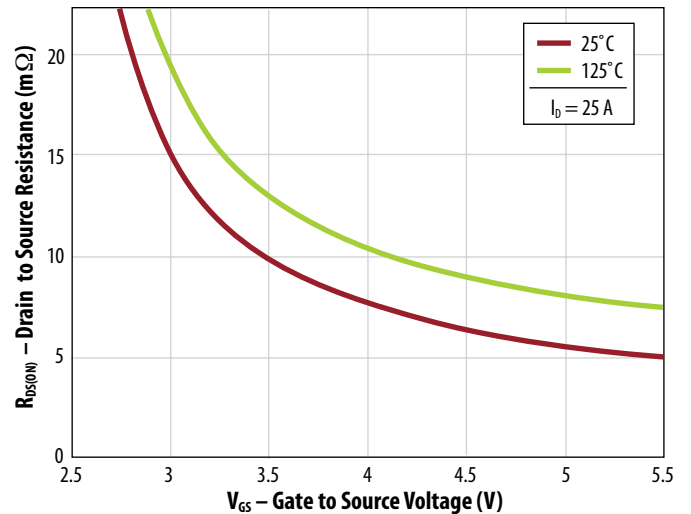

Figure 5: Capacitance

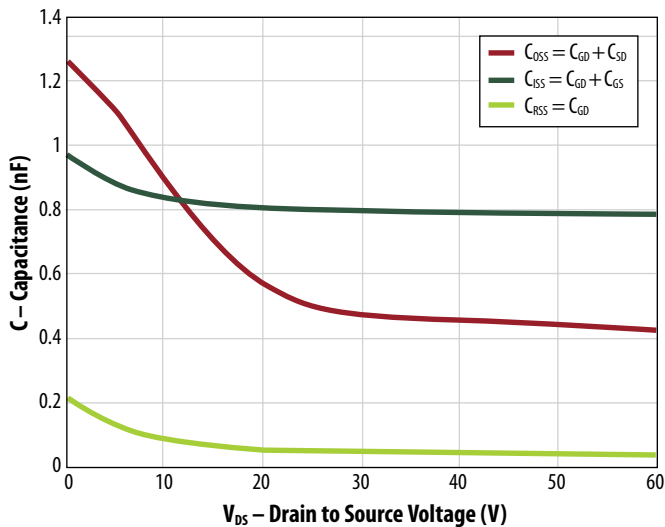

Figure 6: Gate Charge

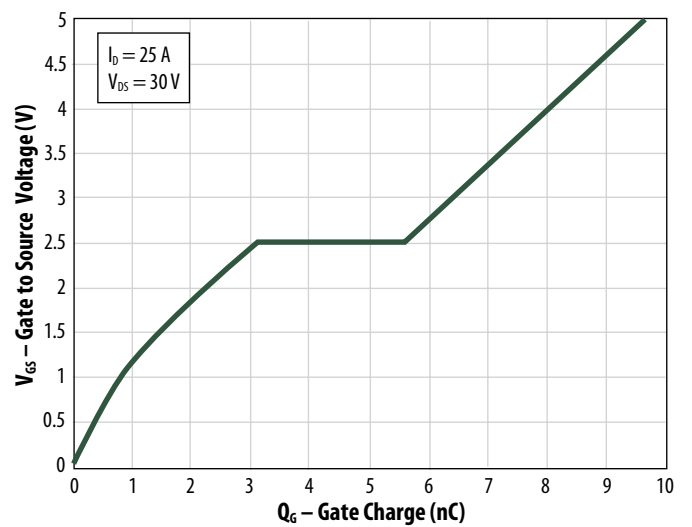

Figure 7: Reverse Drain-Source Characteristics

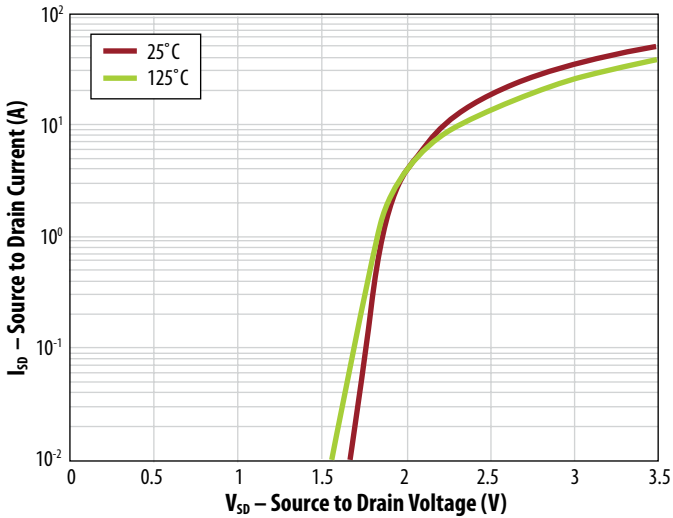

Figure 8: Normalized On Resistance Vs Temperature

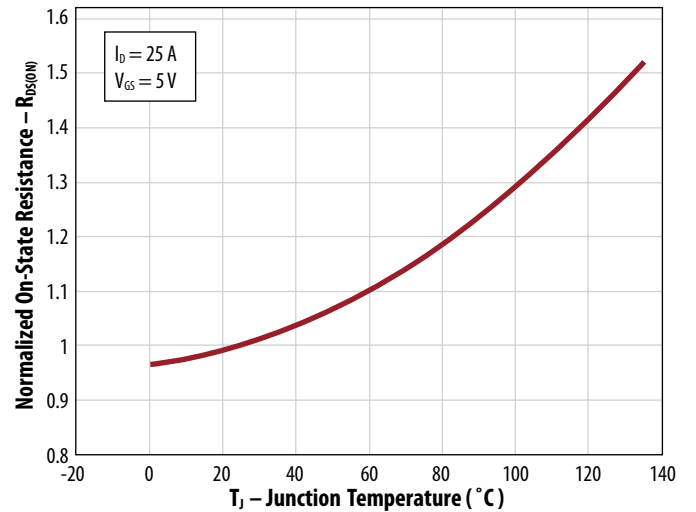

Figure 9: Normalized Threshold Voltage

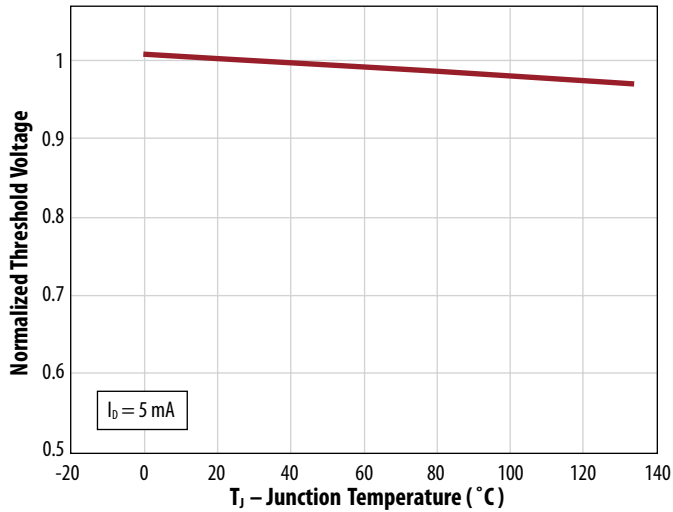
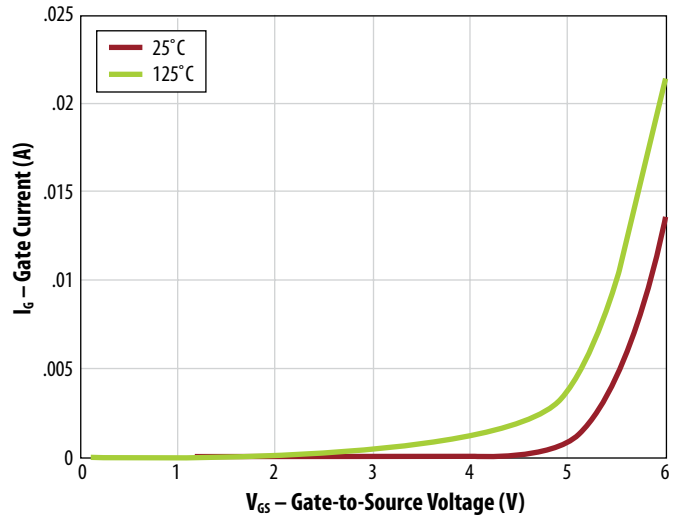
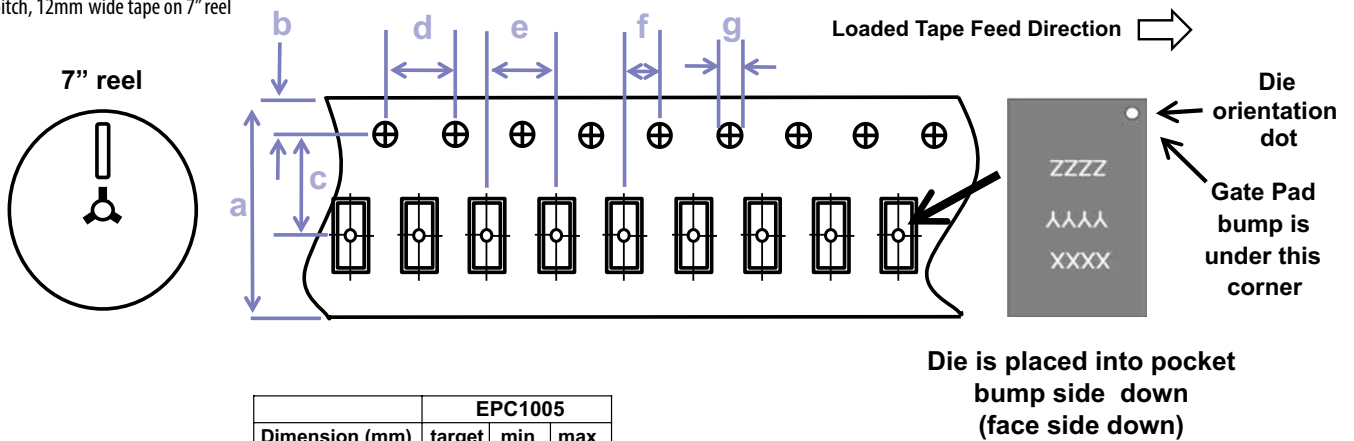

Figure 10: Gate Current



TAPE AND REEL CONFIGURATION

4mm pitch, 12mm wide tape on 7" reel



Dimension (mm)	EPC1005		
	target	min	max
a	12.0	11.7	12.3
b	1.75	1.65	1.85
c (see note)	5.50	5.45	5.55
d	4.00	3.90	4.10
e	4.00	3.90	4.10
f (see note)	2.00	1.95	2.05
g	1.5	1.5	1.6

Note: Pocket position is relative to the sprocket hole measured as true position of the pocket, not the pocket hole

DIE MARKINGS

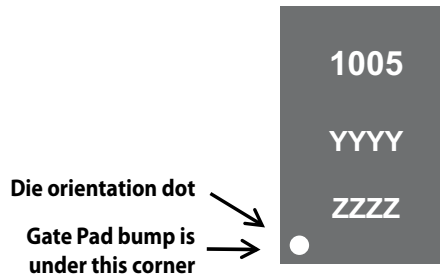

Part Number	Laser Markings		
	Part # Marking Line 1	Lot_Date Code Marking line 2	Lot_Date Code Marking Line 3
EPC1005	1005	YYYY	ZZZZ

DIE OUTLINE

Bottom View

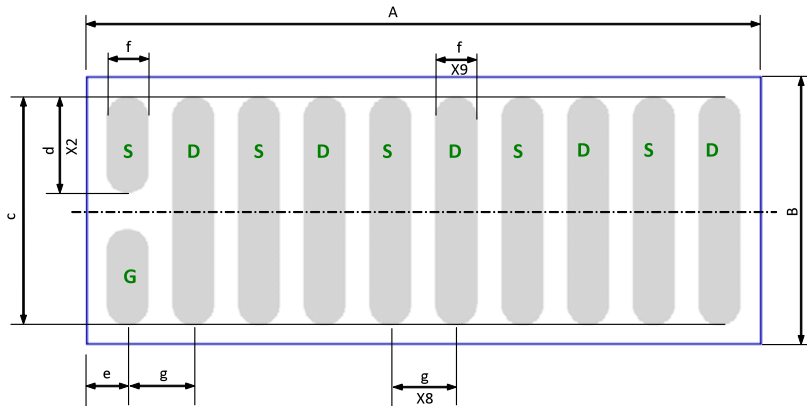

DIM	MICROMETERS		
	MIN	Nominal	MAX
A	4075	4105	4135
B	1602	1632	1662
c	1379	1.382	1.385
d	577	580	583
e	235	250	265
f	248	250	252
g	400	400	400

Side View

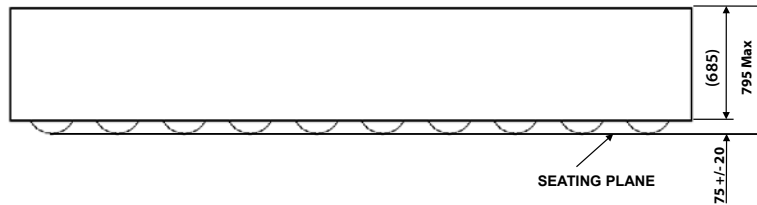

RECOMMENDED LAND PATTERN

(measurements in μm)

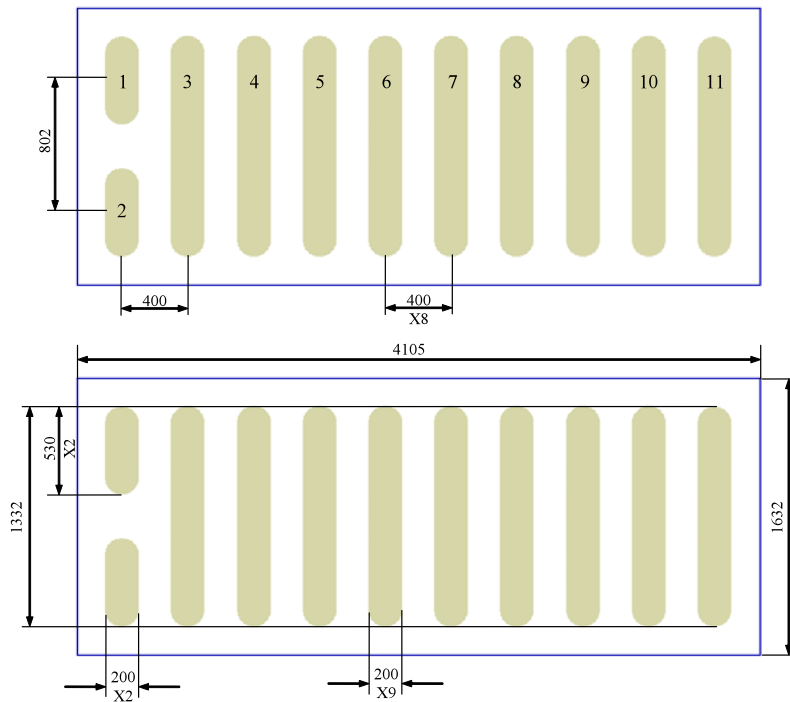

- Pad no. 1 is Gate;
- Pads no. 3, 5, 7, 9, 11 are Drain;
- Pads no. 4, 6, 8, 10 are Source;
- Pad no. 2 is source and is recommended to pin out as a source sense.

Efficient Power Conversion Corporation (EPC) reserves the right to make changes without further notice to any products herein to improve reliability, function or design. EPC does not assume any liability arising out of the application or use of any product or circuit described herein; neither does it convey any license under its patent rights, nor the rights of others.

Information subject to change without notice.
Revised April, 2010