

Power MOSFET

PRODUCT SUMMARY

| | | |
|---------------------------|-----------------|------|
| V_{DS} (V) | 500 | |
| $R_{DS(on)}$ (Ω) | $V_{GS} = 10$ V | 0.85 |
| Q_g (Max.) (nC) | 63 | |
| Q_{gs} (nC) | 9.3 | |
| Q_{gd} (nC) | 32 | |
| Configuration | Single | |

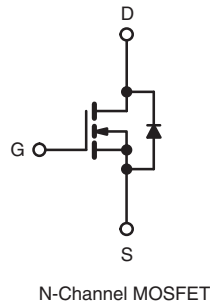
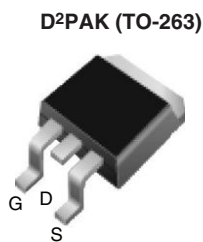

FEATURES

- Halogen-free According to IEC 61249-2-21 Definition
- Surface Mount
- Available in Tape and Reel
- Dynamic dV/dt Rating
- Repetitive Avalanche Rated
- Fast Switching
- Ease of Paralleling
- Simple Drive Requirement
- Compliant to RoHS Directive 2002/95/EC



RoHS*
COMPLIANT
HALOGEN
FREE
Available

DESCRIPTION

Third generation Power MOSFETs from Vishay provide the designer with the best combination of fast switching, ruggedized device design, low on-resistance and cost-effectiveness.

The D²PAK (TO-263) is a surface mount power package capable of accommodating die size up to HEX-4. It provides the highest power capability and the lowest possible on-resistance in any existing surface mount package. The D²PAK (TO-263) is suitable for high current applications because of its low internal connection resistance and can dissipate up to 2.0 W in a typical surface mount application.

ORDERING INFORMATION

| Package | D ² PAK (TO-263) | D ² PAK (TO-263) | D ² PAK (TO-263) |
|---------------------------------|-----------------------------|------------------------------|------------------------------|
| Lead (Pb)-free and Halogen-free | SiHF840S-GE3 | SiHF840STRL-GE3 ^a | SiHF840STRR-GE3 ^a |
| Lead (Pb)-free | IRF840SPbF | IRF840STRLPbF ^a | IRF840STRRPbF ^a |
| | SiHF840S-E3 | SiHF840STL-E3 ^a | SiHF840STR-E3 ^a |

Note

- a. See device orientation.

ABSOLUTE MAXIMUM RATINGS ($T_C = 25$ °C, unless otherwise noted)

| PARAMETER | SYMBOL | LIMIT | UNIT |
|--|----------------|------------------|------|
| Drain-Source Voltage | V_{DS} | 500 | V |
| Gate-Source Voltage | V_{GS} | ± 20 | |
| Continuous Drain Current | I_D | $T_C = 25$ °C | 8.0 |
| | | $T_C = 100$ °C | 5.1 |
| Pulsed Drain Current ^a | I_{DM} | 32 | A |
| Linear Derating Factor | | 1.0 | W/°C |
| Linear Derating Factor (PCB Mount) ^e | | 0.025 | |
| Single Pulse Avalanche Energy ^b | E_{AS} | 510 | mJ |
| Avalanche Current ^a | I_{AR} | 8.0 | A |
| Repetitive Avalanche Energy ^a | E_{AR} | 13 | mJ |
| Maximum Power Dissipation | P_D | $T_C = 25$ °C | 125 |
| | | $T_A = 25$ °C | 3.1 |
| Peak Diode Recovery dV/dt ^c | dV/dt | 3.5 | V/ns |
| Operating Junction and Storage Temperature Range | T_J, T_{stg} | - 55 to + 150 | °C |
| Soldering Recommendations (Peak Temperature) | for 10 s | 300 ^d | |

Notes



- Repetitive rating; pulse width limited by maximum junction temperature (see fig. 11).
- $V_{DD} = 50$ V, starting $T_J = 25$ °C, $L = 14$ mH, $R_g = 25$ Ω , $I_{AS} = 8.0$ A (see fig. 12).
- $I_{SD} \leq 8.0$ A, $dI/dt \leq 100$ A/ μ s, $V_{DD} \leq V_{DS}$, $T_J \leq 150$ °C.
- 1.6 mm from case.
- When mounted on 1" square PCB (FR-4 or G-10 material).

* Pb containing terminations are not RoHS compliant, exemptions may apply

| THERMAL RESISTANCE RATINGS | | | | |
|--|------------|------|------|------|
| PARAMETER | SYMBOL | TYP. | MAX. | UNIT |
| Maximum Junction-to-Ambient | R_{thJA} | - | 62 | °C/W |
| Maximum Junction-to-Ambient (PCB Mount) ^a | R_{thJA} | - | 40 | |
| Maximum Junction-to-Case (Drain) | R_{thJC} | - | 1.0 | |

Note

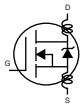
a. When mounted on 1" square PCB (FR-4 or G-10 material).

| SPECIFICATIONS ($T_J = 25\text{ }^\circ\text{C}$, unless otherwise noted) | | | | | | | |
|---|---------------------|--|--|------|------|-----------|---------------|
| PARAMETER | SYMBOL | TEST CONDITIONS | | MIN. | TYP. | MAX. | UNIT |
| Static | | | | | | | |
| Drain-Source Breakdown Voltage | V_{DS} | $V_{GS} = 0\text{ V}, I_D = 250\text{ }\mu\text{A}$ | | 500 | - | - | V |
| V_{DS} Temperature Coefficient | $\Delta V_{DS}/T_J$ | Reference to $25\text{ }^\circ\text{C}$, $I_D = 1\text{ mA}$ | | - | 0.78 | - | V/°C |
| Gate-Source Threshold Voltage | $V_{GS(th)}$ | $V_{DS} = V_{GS}, I_D = 250\text{ }\mu\text{A}$ | | 2.0 | - | 4.0 | V |
| Gate-Source Leakage | I_{GSS} | $V_{GS} = \pm 20\text{ V}$ | | - | - | ± 100 | nA |
| Zero Gate Voltage Drain Current | I_{DSS} | $V_{DS} = 500\text{ V}, V_{GS} = 0\text{ V}$ | | - | - | 25 | μA |
| | | $V_{DS} = 400\text{ V}, V_{GS} = 0\text{ V}, T_J = 125\text{ }^\circ\text{C}$ | | - | - | 250 | |
| Drain-Source On-State Resistance | $R_{DS(on)}$ | $V_{GS} = 10\text{ V}$ | $I_D = 4.8\text{ A}^b$ | - | - | 0.85 | Ω |
| Forward Transconductance | g_{fs} | $V_{DS} = 50\text{ V}, I_D = 4.8\text{ A}^b$ | | 4.9 | - | - | S |
| Dynamic | | | | | | | |
| Input Capacitance | C_{iss} | $V_{GS} = 0\text{ V}, V_{DS} = 25\text{ V}, f = 1.0\text{ MHz}$, see fig. 5 | | - | 1300 | - | pF |
| Output Capacitance | C_{oss} | | | - | 310 | - | |
| Reverse Transfer Capacitance | C_{rss} | | | - | 120 | - | |
| Total Gate Charge | Q_g | $V_{GS} = 10\text{ V}$ | $I_D = 8.0\text{ A}, V_{DS} = 400\text{ V}$, see fig. 6 and 13 ^b | - | - | 63 | nC |
| Gate-Source Charge | Q_{gs} | | | - | - | 9.3 | |
| Gate-Drain Charge | Q_{gd} | | | - | - | 32 | |
| Turn-On Delay Time | $t_{d(on)}$ | $V_{DD} = 250\text{ V}, I_D = 8.0\text{ A}, R_g = 9.1\text{ }\Omega, R_D = 31\text{ }\Omega$, see fig. 10 ^b | | - | 14 | - | ns |
| Rise Time | t_r | | | - | 23 | - | |
| Turn-Off Delay Time | $t_{d(off)}$ | | | - | 49 | - | |
| Fall Time | t_f | | | - | 20 | - | |
| Internal Drain Inductance | L_D | Between lead, 6 mm (0.25") from package and center of die contact  | | - | 4.5 | - | nH |
| Internal Source Inductance | L_S | | | - | 7.5 | - | |
| Drain-Source Body Diode Characteristics | | | | | | | |
| Continuous Source-Drain Diode Current | I_S | MOSFET symbol showing the integral reverse p - n junction diode  | | - | - | 8.0 | A |
| Pulsed Diode Forward Current ^a | I_{SM} | | | - | - | 32 | |
| Body Diode Voltage | V_{SD} | $T_J = 25\text{ }^\circ\text{C}, I_S = 8.0\text{ A}, V_{GS} = 0\text{ V}^b$ | | - | - | 2.0 | V |
| Body Diode Reverse Recovery Time | t_{rr} | $T_J = 25\text{ }^\circ\text{C}, I_F = 8.0\text{ A}, di/dt = 100\text{ A}/\mu\text{s}^b$ | | - | 460 | 970 | ns |
| Body Diode Reverse Recovery Charge | Q_{rr} | | | - | 4.2 | 8.9 | μC |
| Forward Turn-On Time | t_{on} | Intrinsic turn-on time is negligible (turn-on is dominated by L_S and L_D) | | | | | |

Notes

- a. Repetitive rating; pulse width limited by maximum junction temperature (see fig. 11).
- b. Pulse width $\leq 300\text{ }\mu\text{s}$; duty cycle $\leq 2\%$.

TYPICAL CHARACTERISTICS (25 °C, unless otherwise noted)

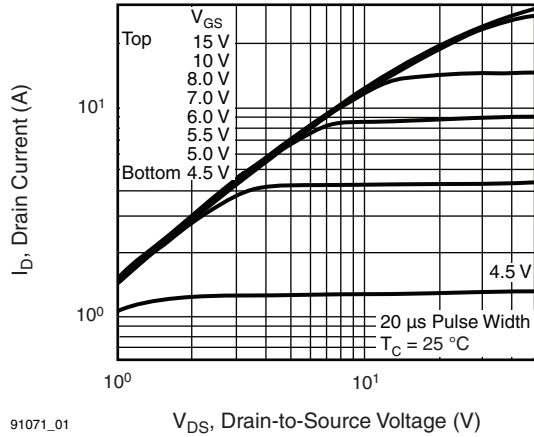

Fig. 1 - Typical Output Characteristics, $T_C = 25\text{ }^\circ\text{C}$

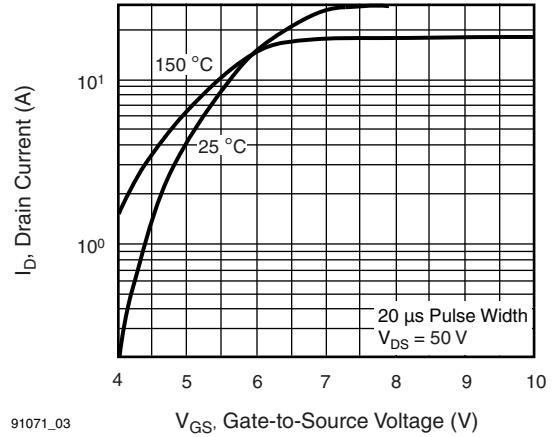

Fig. 3 - Typical Transfer Characteristics

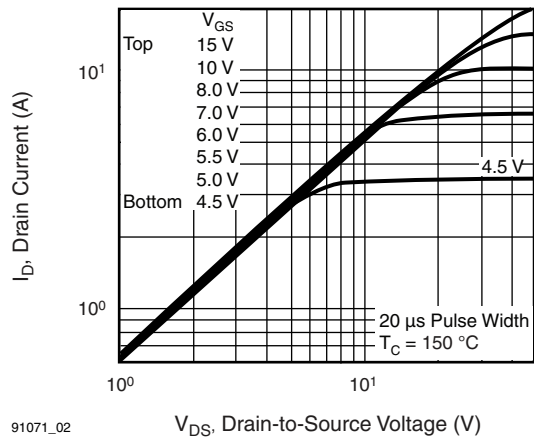

Fig. 2 - Typical Output Characteristics, $T_C = 150\text{ }^\circ\text{C}$

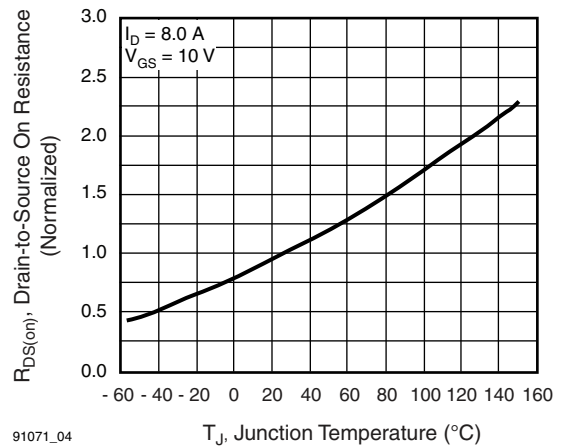
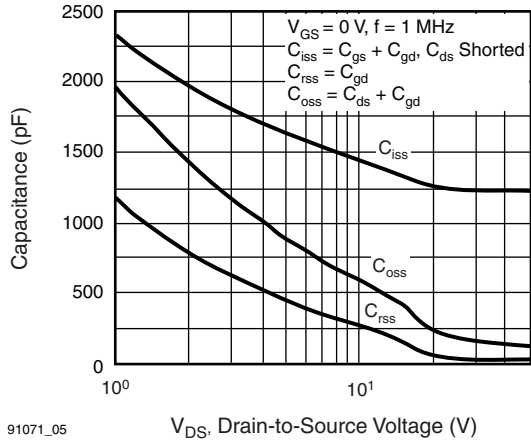
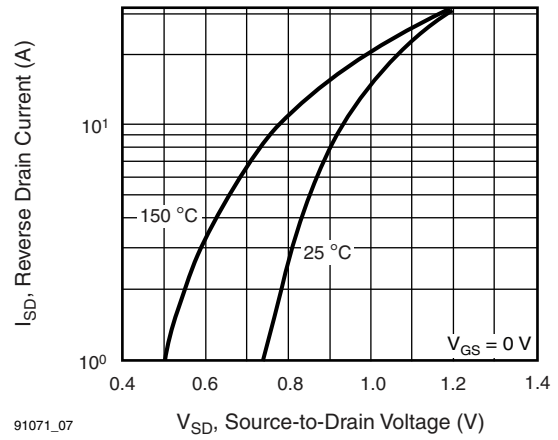

Fig. 4 - Normalized On-Resistance vs. Temperature



91071_05

Fig. 5 - Typical Capacitance vs. Drain-to-Source Voltage



91071_07

Fig. 7 - Typical Source-Drain Diode Forward Voltage

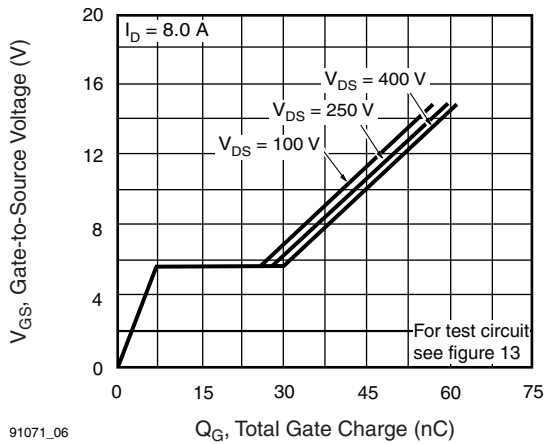

91071_06

Fig. 6 - Typical Gate Charge vs. Gate-to-Source Voltage

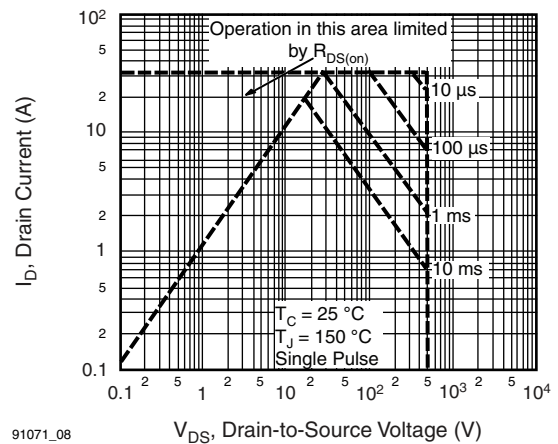

91071_08

Fig. 8 - Maximum Safe Operating Area

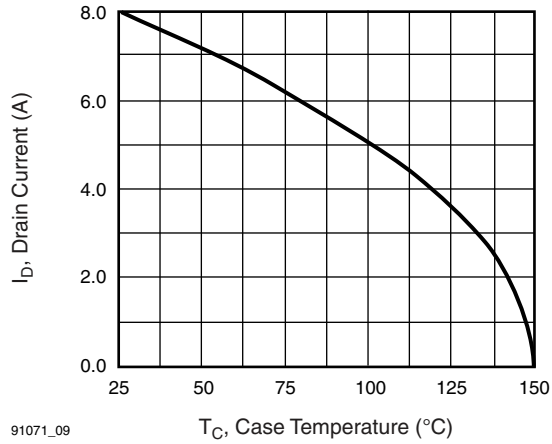

91071_09

Fig. 9 - Maximum Drain Current vs. Case Temperature

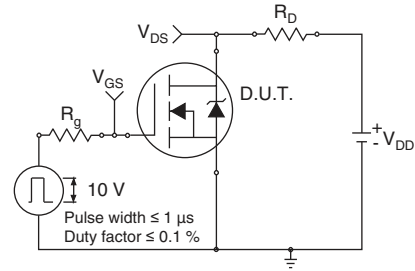
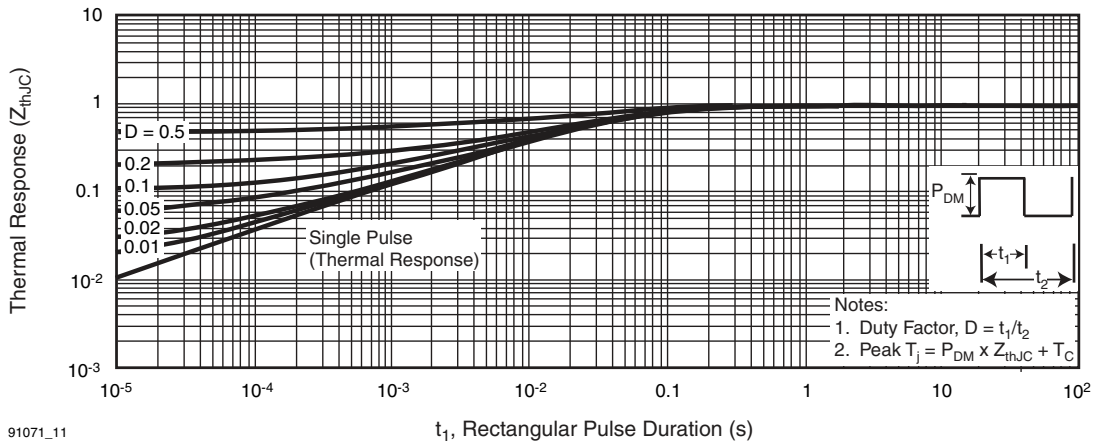

Fig. 10a - Switching Time Test Circuit



Fig. 10b - Switching Time Waveforms



91071_11

Fig. 11 - Maximum Effective Transient Thermal Impedance, Junction-to-Case

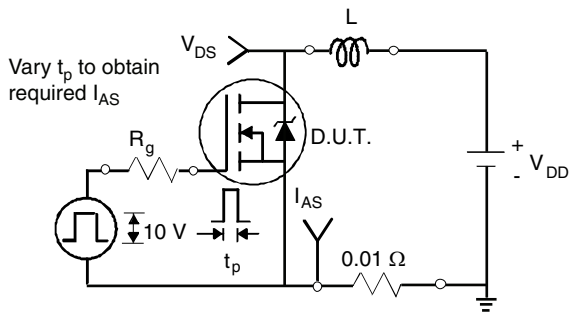

Fig. 12a - Unclamped Inductive Test Circuit



Fig. 12b - Unclamped Inductive Waveforms

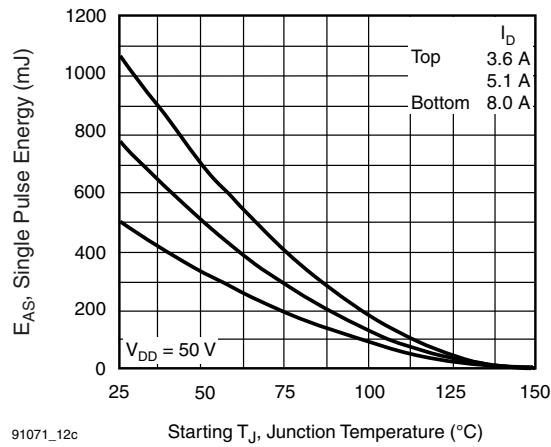

Fig. 12c - Maximum Avalanche Energy vs. Drain Current

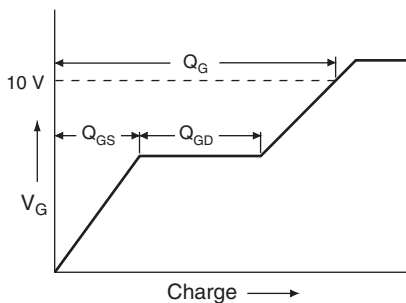

Fig. 13a - Basic Gate Charge Waveform

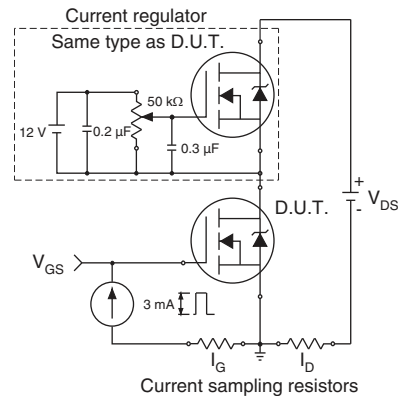
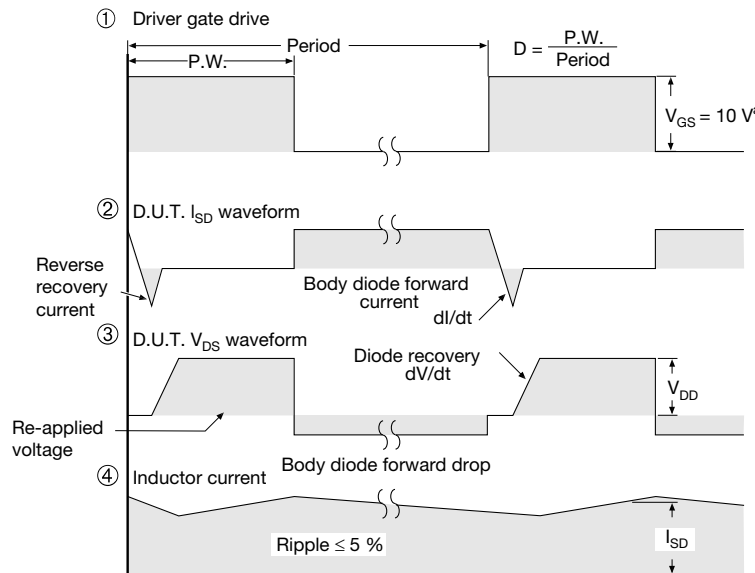
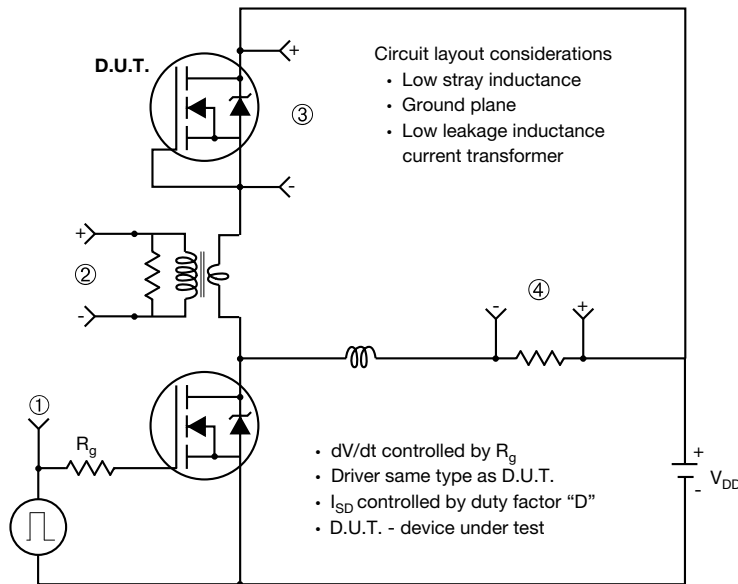

Fig. 13b - Gate Charge Test Circuit

Peak Diode Recovery dV/dt Test Circuit



Note

a. $V_{GS} = 5 V$ for logic level devices

Fig. 14 - For N-Channel

Vishay Siliconix maintains worldwide manufacturing capability. Products may be manufactured at one of several qualified locations. Reliability data for Silicon Technology and Package Reliability represent a composite of all qualified locations. For related documents such as package/tape drawings, part marking, and reliability data, see www.vishay.com/ppg?91071.

TO-263AB (HIGH VOLTAGE)



| DIM. | MILLIMETERS | | INCHES | |
|------|-------------|------|--------|-------|
| | MIN. | MAX. | MIN. | MAX. |
| A | 4.06 | 4.83 | 0.160 | 0.190 |
| A1 | 0.00 | 0.25 | 0.000 | 0.010 |
| b | 0.51 | 0.99 | 0.020 | 0.039 |
| b1 | 0.51 | 0.89 | 0.020 | 0.035 |
| b2 | 1.14 | 1.78 | 0.045 | 0.070 |
| b3 | 1.14 | 1.73 | 0.045 | 0.068 |
| c | 0.38 | 0.74 | 0.015 | 0.029 |
| c1 | 0.38 | 0.58 | 0.015 | 0.023 |
| c2 | 1.14 | 1.65 | 0.045 | 0.065 |
| D | 8.38 | 9.65 | 0.330 | 0.380 |

| DIM. | MILLIMETERS | | INCHES | |
|------|-------------|-------|-----------|-------|
| | MIN. | MAX. | MIN. | MAX. |
| D1 | 6.86 | - | 0.270 | - |
| E | 9.65 | 10.67 | 0.380 | 0.420 |
| E1 | 6.22 | - | 0.245 | - |
| e | 2.54 BSC | | 0.100 BSC | |
| H | 14.61 | 15.88 | 0.575 | 0.625 |
| L | 1.78 | 2.79 | 0.070 | 0.110 |
| L1 | - | 1.65 | - | 0.066 |
| L2 | - | 1.78 | - | 0.070 |
| L3 | 0.25 BSC | | 0.010 BSC | |
| L4 | 4.78 | 5.28 | 0.188 | 0.208 |

ECN: S-82110-Rev. A, 15-Sep-08
DWG: 5970

Notes

1. Dimensioning and tolerancing per ASME Y14.5M-1994.
2. Dimensions are shown in millimeters (inches).
3. Dimension D and E do not include mold flash. Mold flash shall not exceed 0.127 mm (0.005") per side. These dimensions are measured at the outmost extremes of the plastic body at datum A.
4. Thermal PAD contour optional within dimension E, L1, D1 and E1.
5. Dimension b1 and c1 apply to base metal only.
6. Datum A and B to be determined at datum plane H.
7. Outline conforms to JEDEC outline to TO-263AB.

RECOMMENDED MINIMUM PADS FOR D²PAK: 3-Lead



Recommended Minimum Pads
Dimensions in Inches/(mm)

[Return to Index](#)



Disclaimer

ALL PRODUCT, PRODUCT SPECIFICATIONS AND DATA ARE SUBJECT TO CHANGE WITHOUT NOTICE TO IMPROVE RELIABILITY, FUNCTION OR DESIGN OR OTHERWISE.

Vishay Intertechnology, Inc., its affiliates, agents, and employees, and all persons acting on its or their behalf (collectively, "Vishay"), disclaim any and all liability for any errors, inaccuracies or incompleteness contained in any datasheet or in any other disclosure relating to any product.

Vishay makes no warranty, representation or guarantee regarding the suitability of the products for any particular purpose or the continuing production of any product. To the maximum extent permitted by applicable law, Vishay disclaims (i) any and all liability arising out of the application or use of any product, (ii) any and all liability, including without limitation special, consequential or incidental damages, and (iii) any and all implied warranties, including warranties of fitness for particular purpose, non-infringement and merchantability.

Statements regarding the suitability of products for certain types of applications are based on Vishay's knowledge of typical requirements that are often placed on Vishay products in generic applications. Such statements are not binding statements about the suitability of products for a particular application. It is the customer's responsibility to validate that a particular product with the properties described in the product specification is suitable for use in a particular application. Parameters provided in datasheets and/or specifications may vary in different applications and performance may vary over time. All operating parameters, including typical parameters, must be validated for each customer application by the customer's technical experts. Product specifications do not expand or otherwise modify Vishay's terms and conditions of purchase, including but not limited to the warranty expressed therein.

Except as expressly indicated in writing, Vishay products are not designed for use in medical, life-saving, or life-sustaining applications or for any other application in which the failure of the Vishay product could result in personal injury or death. Customers using or selling Vishay products not expressly indicated for use in such applications do so at their own risk and agree to fully indemnify and hold Vishay and its distributors harmless from and against any and all claims, liabilities, expenses and damages arising or resulting in connection with such use or sale, including attorneys fees, even if such claim alleges that Vishay or its distributor was negligent regarding the design or manufacture of the part. Please contact authorized Vishay personnel to obtain written terms and conditions regarding products designed for such applications.

No license, express or implied, by estoppel or otherwise, to any intellectual property rights is granted by this document or by any conduct of Vishay. Product names and markings noted herein may be trademarks of their respective owners.

Material Category Policy

Vishay Intertechnology, Inc. hereby certifies that all its products that are identified as RoHS-Compliant fulfill the definitions and restrictions defined under Directive 2011/65/EU of The European Parliament and of the Council of June 8, 2011 on the restriction of the use of certain hazardous substances in electrical and electronic equipment (EEE) - recast, unless otherwise specified as non-compliant.

Please note that some Vishay documentation may still make reference to RoHS Directive 2002/95/EC. We confirm that all the products identified as being compliant to Directive 2002/95/EC conform to Directive 2011/65/EU.