



## STP60NF06FP

N-channel 60V - 0.014Ω - 30A TO-220FP  
STripFET II™ Power MOSFET

### General features

Type	V <sub>DSS</sub>	R <sub>DS(on)</sub>	I <sub>D</sub>
STP60NF06FP	60V	<0.016Ω	30A

- Exceptional dv/dt capability
- 100% avalanche tested
- Application oriented characterization

### Description

This Power MOSFET series realized with STMicroelectronics unique STripFET process has specifically been designed to minimize input capacitance and gate charge. It is therefore suitable as primary switch in advanced high-efficiency isolated DC-DC converters for Telecom and Computer application. It is also intended for any application with low gate charge drive requirements.

### Applications

- Switching application

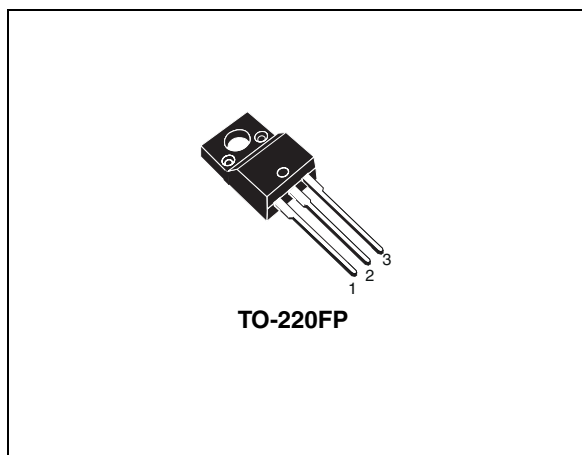

### Internal schematic diagram

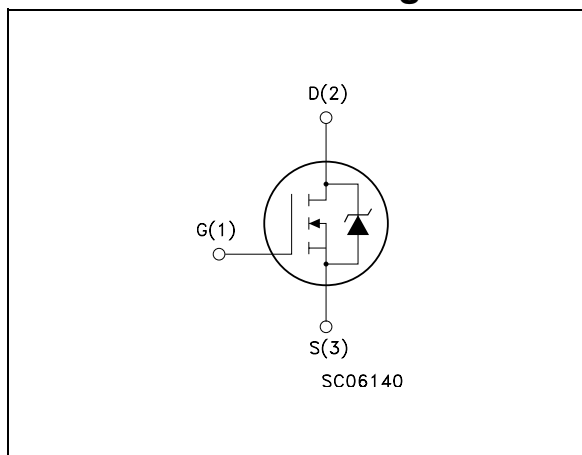

### Order code

Part number	Marking	Package	Packaging
STP60NF06FP	P60NF06	TO-220FP	Tube

# Contents

<b>1</b>	<b>Electrical ratings</b> .....	<b>3</b>
<b>2</b>	<b>Electrical characteristics</b> .....	<b>4</b>
	2.1 Electrical characteristics (curves) .....	6
<b>3</b>	<b>Test circuit</b> .....	<b>8</b>
<b>4</b>	<b>Package mechanical data</b> .....	<b>9</b>
<b>5</b>	<b>Revision history</b> .....	<b>11</b>

# 1 Electrical ratings

**Table 1. Absolute maximum ratings**

Symbol	Parameter	Value	Unit
$V_{DS}$	Drain-source voltage ( $V_{GS} = 0$ )	60	V
$V_{GS}$	Gate- source voltage	$\pm 20$	V
$I_D$	Drain current (continuous) at $T_C = 25^\circ\text{C}$	30	A
$I_D$	Drain current (continuous) at $T_C = 100^\circ\text{C}$	21	A
$I_{DM}^{(1)}$	Drain current (pulsed)	120	A
$P_{TOT}$	Total dissipation at $T_C = 25^\circ\text{C}$	30	W
	Derating factor	0.2	W/ $^\circ\text{C}$
$dv/dt^{(2)}$	Peak diode recovery voltage slope	4	V/ns
$V_{ISO}$	Insulation withstand voltage (RMS) from all three leads to external heat sink ( $t=1\text{s}$ ; $T_C= 25^\circ\text{C}$ )	2500	V
$T_{stg}$	Storage temperature	- 55 to 175	$^\circ\text{C}$
$T_j$	Max. operating junction temperature		

1. Pulse width limited by safe operating area

2.  $I_{SD} \leq 60\text{A}$ ,  $di/dt \leq 400\text{ A}/\mu\text{s}$ ,  $V_{DD} \leq 24\text{V}$ ,  $T_j \leq T_{jmax}$

**Table 2. Thermal data**

Symbol	Parameter	Value	Unit
$R_{thj-case}$	Thermal resistance junction-case max	5	$^\circ\text{C}/\text{W}$
$R_{thj-a}$	Thermal resistance junction-ambient max	62.5	$^\circ\text{C}/\text{W}$
$T_l$	Maximum lead temperature for soldering purpose	300	$^\circ\text{C}$

**Table 3. Avalanche characteristics**

Symbol	Parameter	Value	Unit
$I_{AS}$	Avalanche current, repetitive or not-repetitive (pulse width limited by $T_j$ Max)	30	A
$E_{AS}$	Single pulse avalanche energy (starting $T_j=25^\circ\text{C}$ , $I_d=I_{as}$ , $V_{dd}=30\text{V}$ )	370	mJ

## 2 Electrical characteristics

( $T_{CASE}=25^{\circ}C$  unless otherwise specified)

**Table 4. On/off states**

Symbol	Parameter	Test conditions	Min.	Typ.	Max.	Unit
$V_{(BR)DSS}$	Drain-source Breakdown voltage	$I_D = 250 \mu A, V_{GS} = 0$	60			V
$I_{DSS}$	Zero gate voltage Drain current ( $V_{GS} = 0$ )	$V_{DS} = \text{Max rating}$ $V_{DS} = \text{Max rating}, T_C = 125^{\circ}C$			1 10	$\mu A$ $\mu A$
$I_{GSS}$	Gate-body leakage current ( $V_{DS} = 0$ )	$V_{GS} = \pm 20V$			$\pm 100$	nA
$V_{GS(th)}$	Gate threshold voltage	$V_{DS} = V_{GS}, I_D = 250 \mu A$	2		4	V
$R_{DS(on)}$	Static drain-source on resistance	$V_{GS} = 10V, I_D = 30A$		0.014	0.016	$\Omega$

**Table 5. Dynamic**

Symbol	Parameter	Test conditions	Min.	Typ.	Max.	Unit
$g_{fs}^{(1)}$	Forward transconductance	$V_{DS} = 15V, I_D = 30A$		50		S
$C_{iss}$	Input capacitance			1810		pF
$C_{oss}$	Output capacitance	$V_{DS} = 25V, f = 1 \text{ MHz},$ $V_{GS} = 0$		360		pF
$C_{rss}$	Reverse transfer capacitance			125		pF
$Q_g$	Total gate charge	$V_{DD} = 48V, I_D = 60A,$ $V_{GS} = 10V$		49	66	nC
$Q_{gs}$	Gate-source charge	$V_{GS} = 10V$		18		nC
$Q_{gd}$	Gate-drain charge	(see Figure 12)		14		nC

1. Pulsed: Pulse duration = 300  $\mu s$ , duty cycle 1.5%

**Table 6. Switching times**

Symbol	Parameter	Test conditions	Min.	Typ.	Max.	Unit
$t_{d(on)}$	Turn-on delay time	$V_{DD} = 30V, I_D = 30A$ $R_G = 4.7\Omega, V_{GS} = 10V$ (see Figure 13)		16		ns
$t_r$	Rise time			108		ns
$t_{d(off)}$	Turn-off-delay time	$V_{DD} = 30V, I_D = 30A,$ $R_G = 4.7\Omega, V_{GS} = 10V$ (see Figure 13)		43		ns
$t_f$	Fall time			20		ns

Table 7. Source drain diode

Symbol	Parameter	Test conditions	Min	Typ.	Max	Unit
$I_{SD}$	Source-drain current				30	A
$I_{SDM}^{(1)}$	Source-drain current (pulsed)				120	A
$V_{SD}^{(2)}$	Forward on voltage	$I_{SD} = 60A, V_{GS} = 0$			1.3	V
$t_{rr}$	Reverse recovery time	$I_{SD} = 60A, V_{DD}=25V$ di/dt = 100A/ $\mu$ s, $T_j = 150^\circ C$ (see Figure 13)		75		ns
$Q_{rr}$	Reverse recovery charge			182		nC
$I_{RRM}$	Reverse recovery current			5		A

1. Pulse width limited by safe operating area
2. Pulsed: Pulse duration = 300  $\mu$ s, duty cycle 1.5%

## 2.1 Electrical characteristics (curves)

Figure 1. Safe operating area

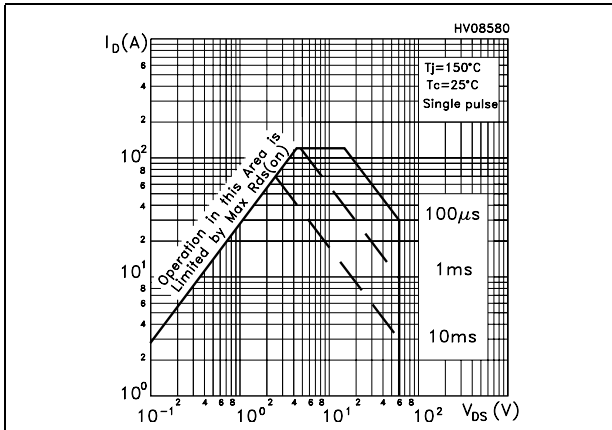

Figure 2. Thermal impedance

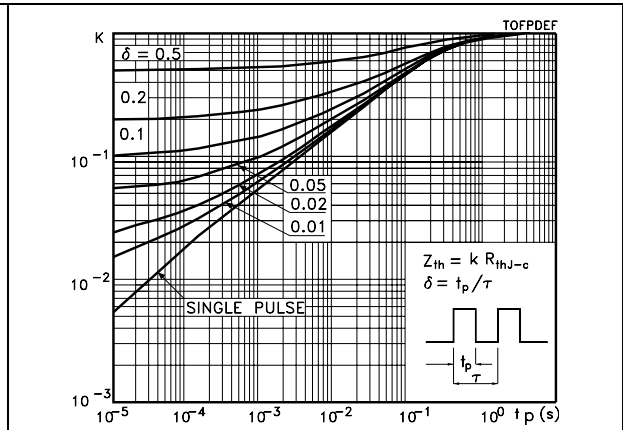

Figure 3. Output characteristics

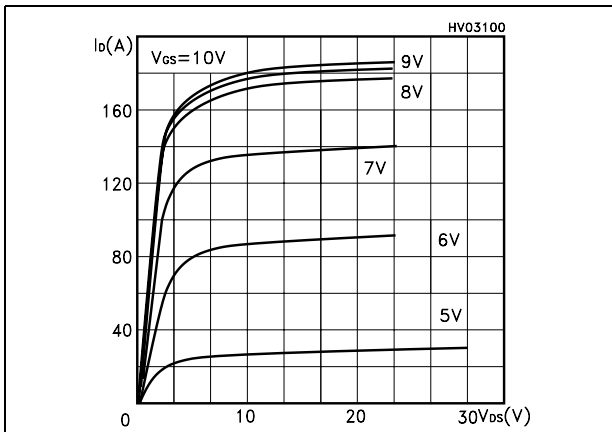

Figure 4. Transfer characteristics

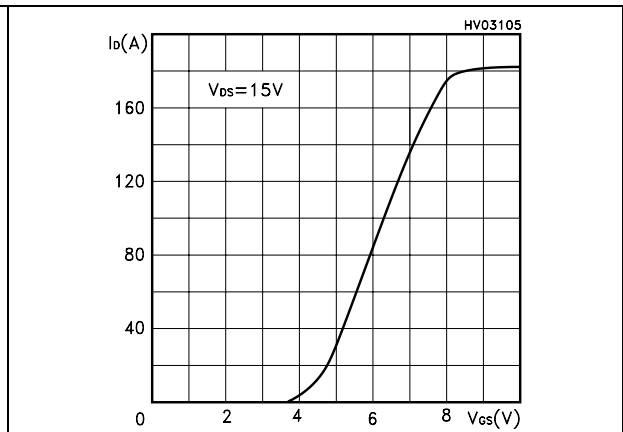

Figure 5. Source-drain diode forward characteristics

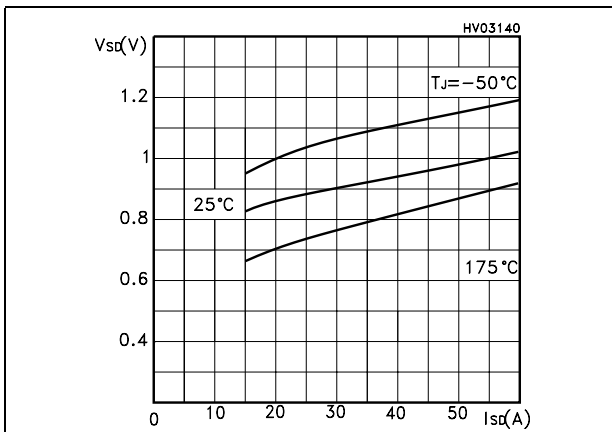

Figure 6. Static drain-source on resistance

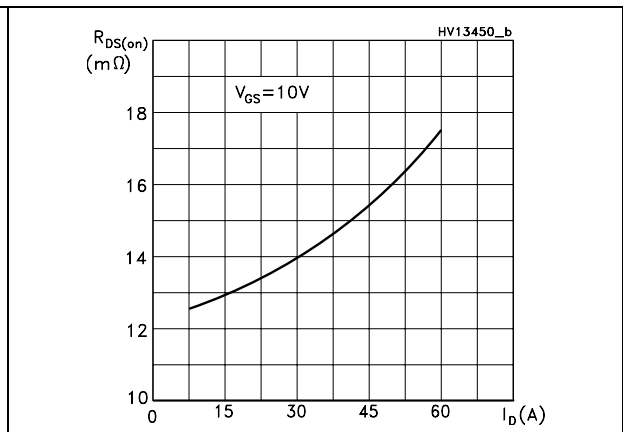

Figure 7. Gate charge vs gate-source voltage Figure 8. Capacitance variations

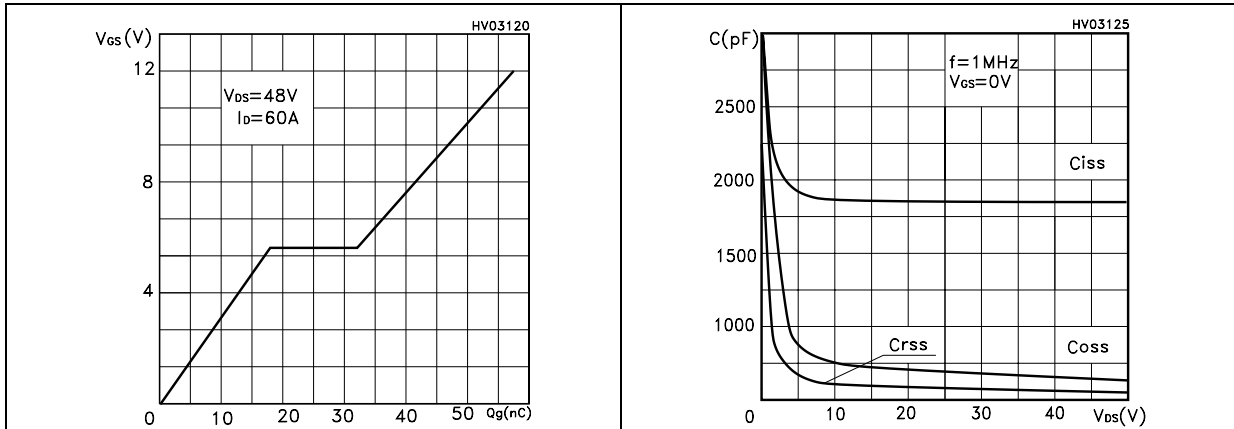
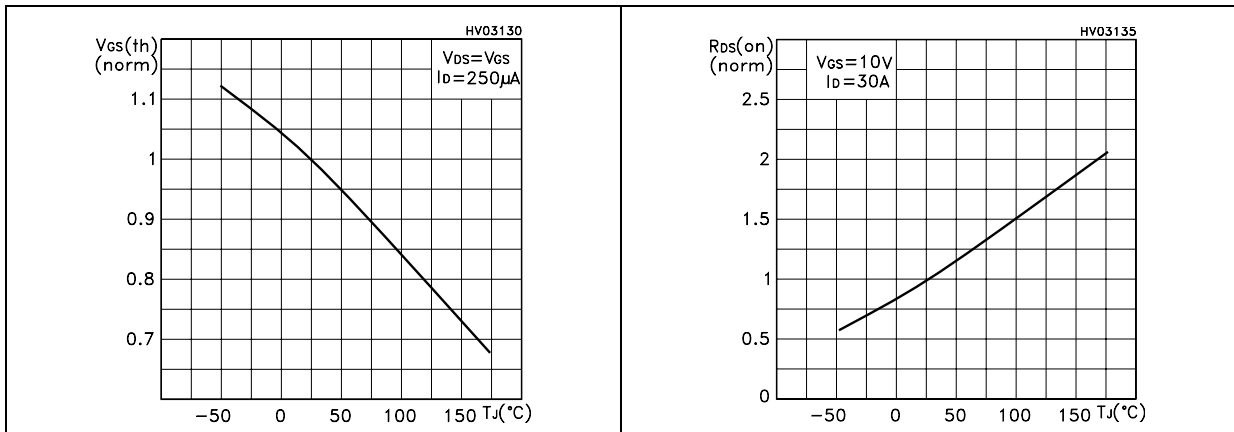

Figure 9. Normalized gate threshold voltage vs temperature Figure 10. Normalized on resistance vs temperature



### 3 Test circuit

Figure 11. Switching times test circuit for resistive load



Figure 12. Gate charge test circuit



Figure 13. Test circuit for inductive load switching and diode recovery times



Figure 14. Unclamped Inductive load test circuit



Figure 15. Unclamped inductive waveform

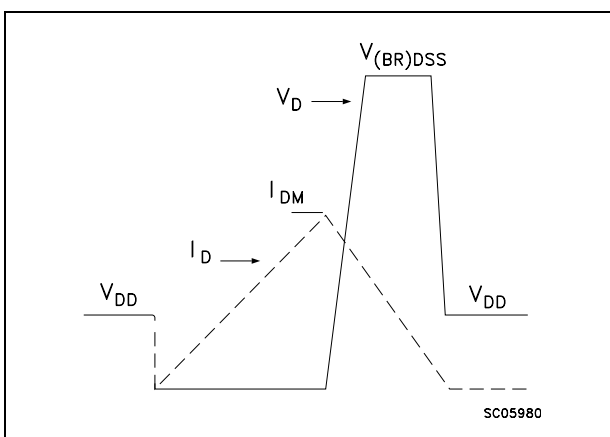
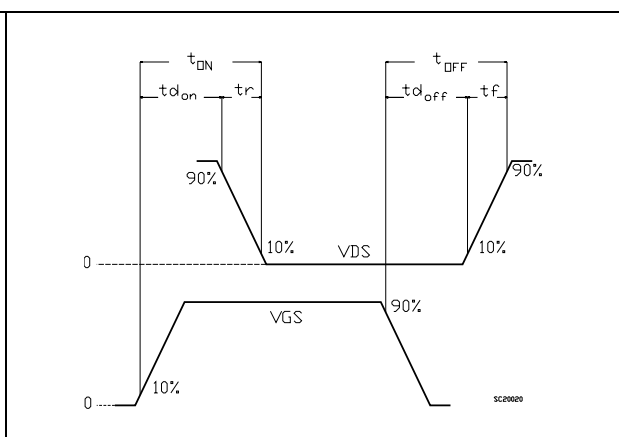

Figure 16. Switching time waveform





## 4 Package mechanical data

In order to meet environmental requirements, ST offers these devices in ECOPACK® packages. These packages have a Lead-free second level interconnect. The category of second level interconnect is marked on the package and on the inner box label, in compliance with JEDEC Standard JESD97. The maximum ratings related to soldering conditions are also marked on the inner box label. ECOPACK is an ST trademark. ECOPACK specifications are available at: [www.st.com](http://www.st.com)

**TO-220FP MECHANICAL DATA**

DIM.	mm.			inch		
	MIN.	TYP.	MAX.	MIN.	TYP.	MAX.
A	4.4		4.6	0.173		0.181
B	2.5		2.7	0.098		0.106
D	2.5		2.75	0.098		0.108
E	0.45		0.7	0.017		0.027
F	0.75		1	0.030		0.039
F1	1.15		1.7	0.045		0.067
F2	1.15		1.7	0.045		0.067
G	4.95		5.2	0.195		0.204
G1	2.4		2.7	0.094		0.106
H	10		10.4	0.393		0.409
L2		16			0.630	
L3	28.6		30.6	1.126		1.204
L4	9.8		10.6	.0385		0.417
L5	2.9		3.6	0.114		0.141
L6	15.9		16.4	0.626		0.645
L7	9		9.3	0.354		0.366
Ø	3		3.2	0.118		0.126

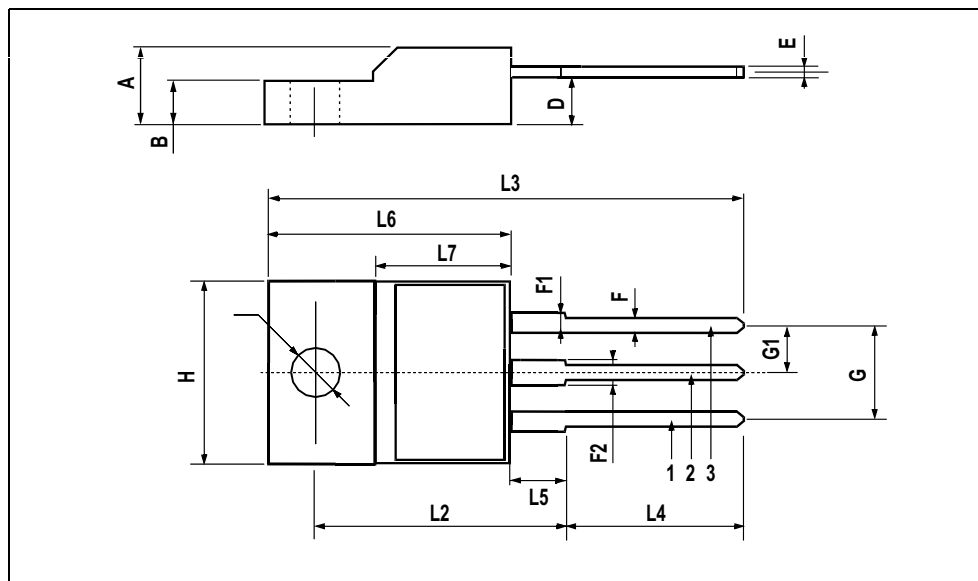

## 5 Revision history

Table 8. Revision history

Date	Revision	Changes
14-Mar-2007	1	First release

**Please Read Carefully:**

Information in this document is provided solely in connection with ST products. STMicroelectronics NV and its subsidiaries ("ST") reserve the right to make changes, corrections, modifications or improvements, to this document, and the products and services described herein at any time, without notice.

All ST products are sold pursuant to ST's terms and conditions of sale.

Purchasers are solely responsible for the choice, selection and use of the ST products and services described herein, and ST assumes no liability whatsoever relating to the choice, selection or use of the ST products and services described herein.

No license, express or implied, by estoppel or otherwise, to any intellectual property rights is granted under this document. If any part of this document refers to any third party products or services it shall not be deemed a license grant by ST for the use of such third party products or services, or any intellectual property contained therein or considered as a warranty covering the use in any manner whatsoever of such third party products or services or any intellectual property contained therein.

**UNLESS OTHERWISE SET FORTH IN ST'S TERMS AND CONDITIONS OF SALE ST DISCLAIMS ANY EXPRESS OR IMPLIED WARRANTY WITH RESPECT TO THE USE AND/OR SALE OF ST PRODUCTS INCLUDING WITHOUT LIMITATION IMPLIED WARRANTIES OF MERCHANTABILITY, FITNESS FOR A PARTICULAR PURPOSE (AND THEIR EQUIVALENTS UNDER THE LAWS OF ANY JURISDICTION), OR INFRINGEMENT OF ANY PATENT, COPYRIGHT OR OTHER INTELLECTUAL PROPERTY RIGHT.**

**UNLESS EXPRESSLY APPROVED IN WRITING BY AN AUTHORIZED ST REPRESENTATIVE, ST PRODUCTS ARE NOT RECOMMENDED, AUTHORIZED OR WARRANTED FOR USE IN MILITARY, AIR CRAFT, SPACE, LIFE SAVING, OR LIFE SUSTAINING APPLICATIONS, NOR IN PRODUCTS OR SYSTEMS WHERE FAILURE OR MALFUNCTION MAY RESULT IN PERSONAL INJURY, DEATH, OR SEVERE PROPERTY OR ENVIRONMENTAL DAMAGE. ST PRODUCTS WHICH ARE NOT SPECIFIED AS "AUTOMOTIVE GRADE" MAY ONLY BE USED IN AUTOMOTIVE APPLICATIONS AT USER'S OWN RISK.**

Resale of ST products with provisions different from the statements and/or technical features set forth in this document shall immediately void any warranty granted by ST for the ST product or service described herein and shall not create or extend in any manner whatsoever, any liability of ST.

ST and the ST logo are trademarks or registered trademarks of ST in various countries.

Information in this document supersedes and replaces all information previously supplied.

The ST logo is a registered trademark of STMicroelectronics. All other names are the property of their respective owners.

© 2007 STMicroelectronics - All rights reserved

STMicroelectronics group of companies

Australia - Belgium - Brazil - Canada - China - Czech Republic - Finland - France - Germany - Hong Kong - India - Israel - Italy - Japan - Malaysia - Malta - Morocco - Singapore - Spain - Sweden - Switzerland - United Kingdom - United States of America

[www.st.com](http://www.st.com)