

V_{DS}	40	V
$R_{DS(on) \text{ max}}$ (@ $V_{GS} = 4.5V$)	3.2	mΩ
Q_g (typical)	43	nC
R_G (typical)	1.2	Ω
I_D (@ $T_{mb} = 25^\circ C$)	100 Ⓞ	A

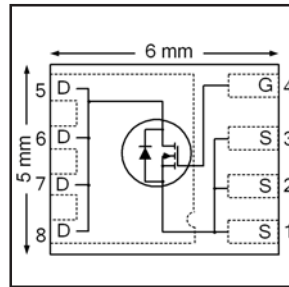

Applications

- Secondary Side Synchronous Rectification
- Inverters for DC Motors
- DC-DC Brick Applications
- Boost Converters

Features

Low R_{DSon} ($\leq 3.2m\Omega$ @ $V_{gs} = 4.5V$)
Low Thermal Resistance to PCB ($\leq 0.8^\circ C/W$)
100% Rg tested
Low Profile (≤ 0.9 mm)
Industry-Standard Pinout
Compatible with Existing Surface Mount Techniques
RoHS Compliant Containing no Lead, no Bromide and no Halogen
MSL1, Industrial Qualification

results in

⇒

Benefits

Lower Conduction Losses
Enable better thermal dissipation
Increased Reliability
Increased Power Density
Multi-Vendor Compatibility
Easier Manufacturing
Environmentally Friendlier
Increased Reliability

Base part number	Package Type	Standard Pack		Orderable part number
		Form	Quantity	
IRLH5034PBF	PQFN 5mm x 6mm	Tape and Reel	4000	IRLH5034TRPBF

Absolute Maximum Ratings

	Parameter	Max.	Units
V_{DS}	Drain-to-Source Voltage	40	V
V_{GS}	Gate-to-Source Voltage	± 16	
I_D @ $T_A = 25^\circ C$	Continuous Drain Current, V_{GS} @ 10V	29	A
I_D @ $T_A = 70^\circ C$	Continuous Drain Current, V_{GS} @ 10V	23	
I_D @ $T_{mb} = 25^\circ C$	Continuous Drain Current, V_{GS} @ 10V	100Ⓞ	
I_D @ $T_{mb} = 100^\circ C$	Continuous Drain Current, V_{GS} @ 10V	100Ⓞ	
I_{DM}	Pulsed Drain Current ①	400	
P_D @ $T_A = 25^\circ C$	Power Dissipation ⑤	3.6	W
P_D @ $T_{mb} = 25^\circ C$	Power Dissipation ⑤	156	
	Linear Derating Factor ⑤	0.029	W/°C
T_J	Operating Junction and	-55 to +150	°C
T_{STG}	Storage Temperature Range		

Notes ① through ⑤ are on page 8

Static @ T_J = 25°C (unless otherwise specified)

	Parameter	Min.	Typ.	Max.	Units	Conditions
B _V DSS	Drain-to-Source Breakdown Voltage	40	—	—	V	V _{GS} = 0V, I _D = 250μA
ΔB _V DSS/ΔT _J	Breakdown Voltage Temp. Coefficient	—	0.04	—	V/°C	Reference to 25°C, I _D = 1mA
R _{DS(on)}	Static Drain-to-Source On-Resistance	—	2.0	2.4	mΩ	V _{GS} = 10V, I _D = 50A ③
		—	2.7	3.2		V _{GS} = 4.5V, I _D = 50A ③
V _{GS(th)}	Gate Threshold Voltage	1.0	—	2.5	V	V _{DS} = V _{GS} , I _D = 150μA
ΔV _{GS(th)}	Gate Threshold Voltage Coefficient	—	-6.4	—	mV/°C	
I _{DSS}	Drain-to-Source Leakage Current	—	—	20	μA	V _{DS} = 40V, V _{GS} = 0V
		—	—	250		V _{DS} = 40V, V _{GS} = 0V, T _J = 125°C
I _{GSS}	Gate-to-Source Forward Leakage	—	—	100	nA	V _{GS} = 16V
	Gate-to-Source Reverse Leakage	—	—	-100		V _{GS} = -16V
g _{fs}	Forward Transconductance	130	—	—	S	V _{DS} = 10V, I _D = 50A
Q _g	Total Gate Charge	—	82	—	nC	V _{GS} = 10V, V _{DS} = 20V, I _D = 50A
Q _g	Total Gate Charge	—	43	65	nC	V _{DS} = 20V V _{GS} = 4.5V I _D = 50A See Fig.17 & 18
Q _{gs1}	Pre-V _{th} Gate-to-Source Charge	—	8.1	—		
Q _{gs2}	Post-V _{th} Gate-to-Source Charge	—	5.0	—		
Q _{gd}	Gate-to-Drain Charge	—	24	—		
Q _{godr}	Gate Charge Overdrive	—	5.9	—		
Q _{sw}	Switch Charge (Q _{gs2} + Q _{gd})	—	29	—		
Q _{oss}	Output Charge	—	31	—	nC	V _{DS} = 16V, V _{GS} = 0V
R _G	Gate Resistance	—	1.2	—	Ω	
t _{d(on)}	Turn-On Delay Time	—	21	—	ns	V _{DD} = 20V, V _{GS} = 4.5V I _D = 50A R _G = 1.8Ω See Fig.15
t _r	Rise Time	—	54	—		
t _{d(off)}	Turn-Off Delay Time	—	31	—		
t _f	Fall Time	—	21	—		
C _{iss}	Input Capacitance	—	4730	—	pF	V _{GS} = 0V V _{DS} = 25V f = 1.0MHz
C _{oss}	Output Capacitance	—	860	—		
C _{rss}	Reverse Transfer Capacitance	—	460	—		

Avalanche Characteristics

	Parameter	Typ.	Max.	Units
E _{AS}	Single Pulse Avalanche Energy ②	—	360	mJ
I _{AR}	Avalanche Current ①	—	50	A

Diode Characteristics

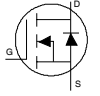
	Parameter	Min.	Typ.	Max.	Units	Conditions
I _S	Continuous Source Current (Body Diode)	—	—	100	A	MOSFET symbol showing the integral reverse p-n junction diode. 
I _{SM}	Pulsed Source Current (Body Diode) ①	—	—	400		
V _{SD}	Diode Forward Voltage	—	—	1.3	V	T _J = 25°C, I _S = 50A, V _{GS} = 0V ③
t _{rr}	Reverse Recovery Time	—	25	38	ns	T _J = 25°C, I _F = 50A, V _{DD} = 20V
Q _{rr}	Reverse Recovery Charge	—	74	110	nC	di/dt = 400A/μs ③
t _{on}	Forward Turn-On Time	Time is dominated by parasitic Inductance				

Thermal Resistance

	Parameter	Typ.	Max.	Units
R _{θJC-mb}	Junction-to-Mounting Base	0.5	0.8	°C/W
R _{θJC} (Top)	Junction-to-Case ④	—	15	
R _{θJA}	Junction-to-Ambient ⑤	—	35	
R _{θJA} (<10s)	Junction-to-Ambient ⑤	—	22	

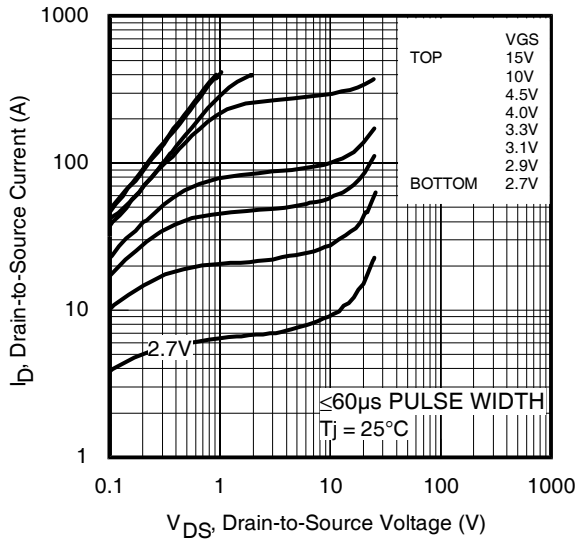
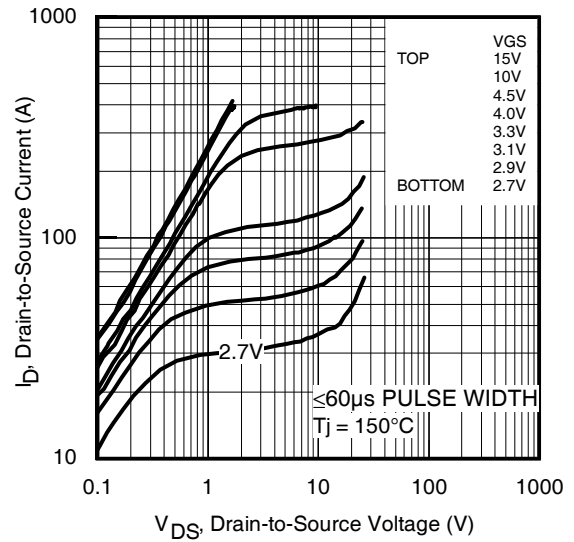
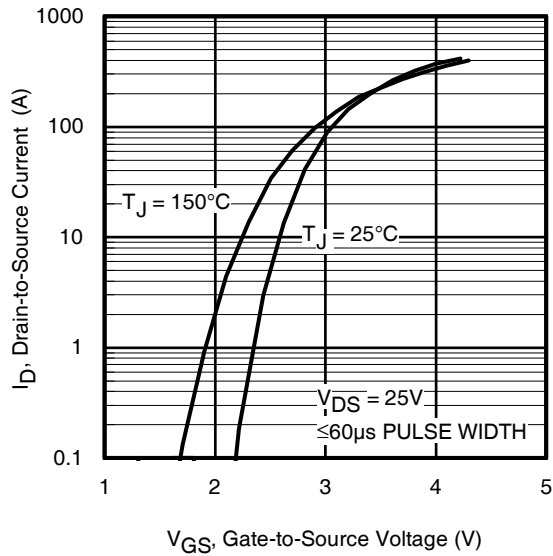
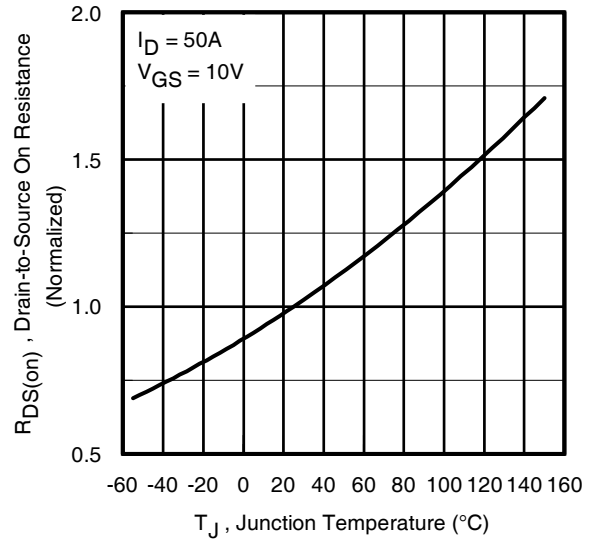
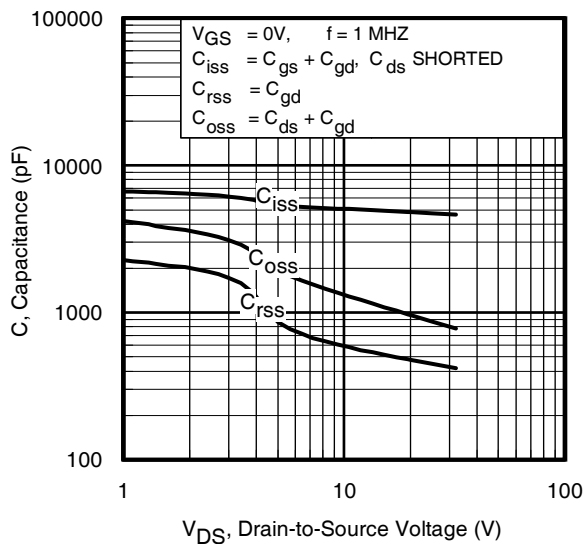
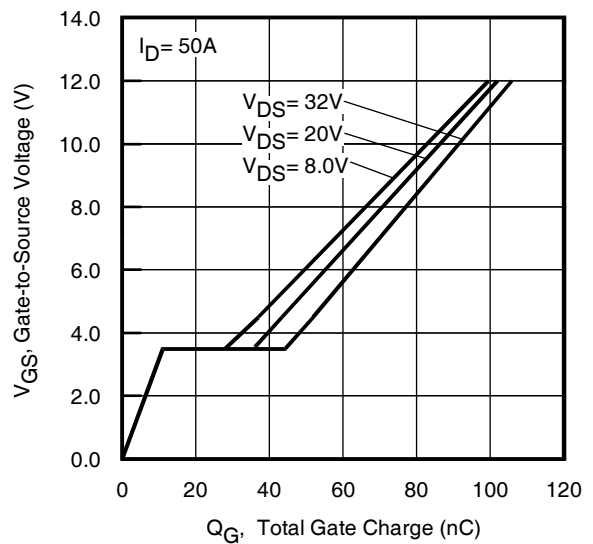
Fig 1. Typical Output Characteristics

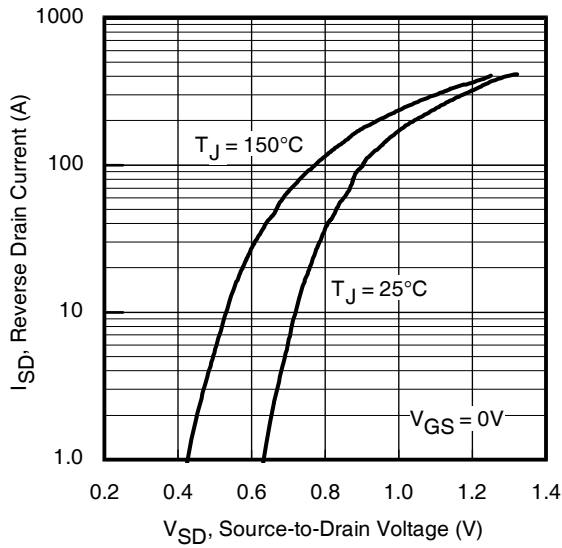
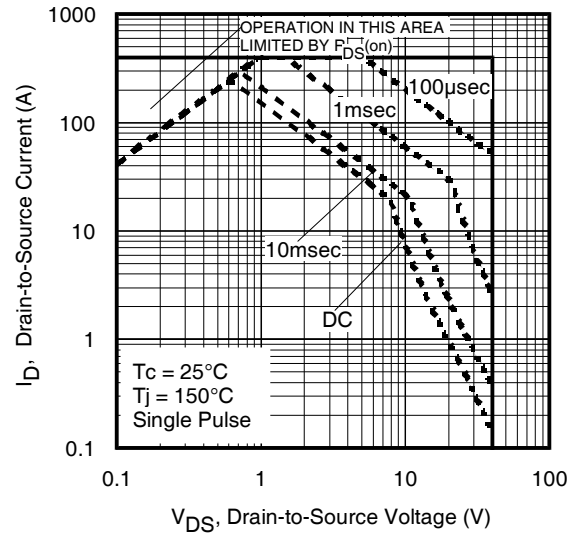
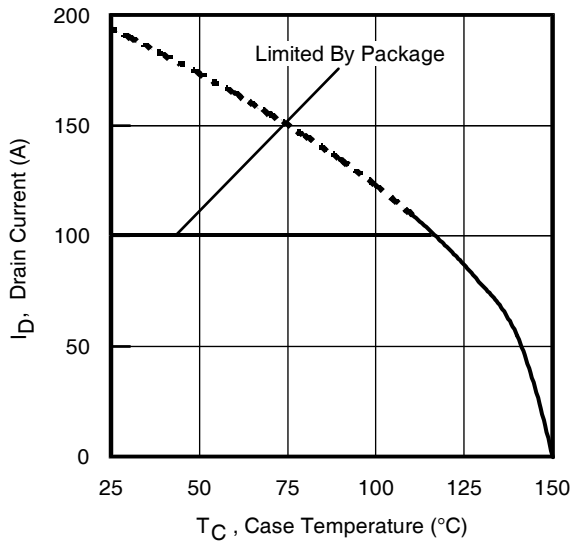
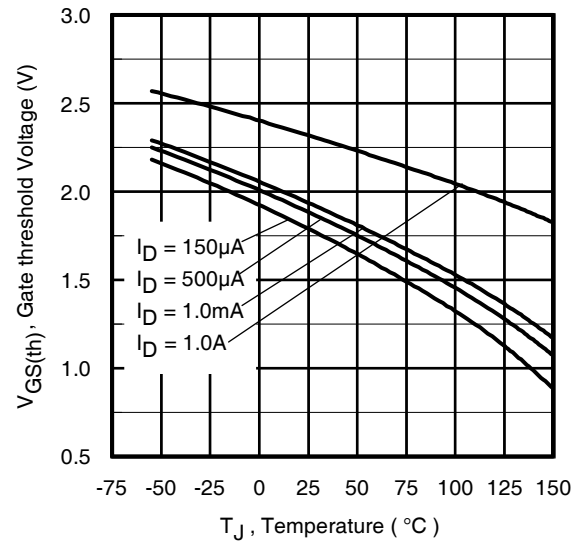
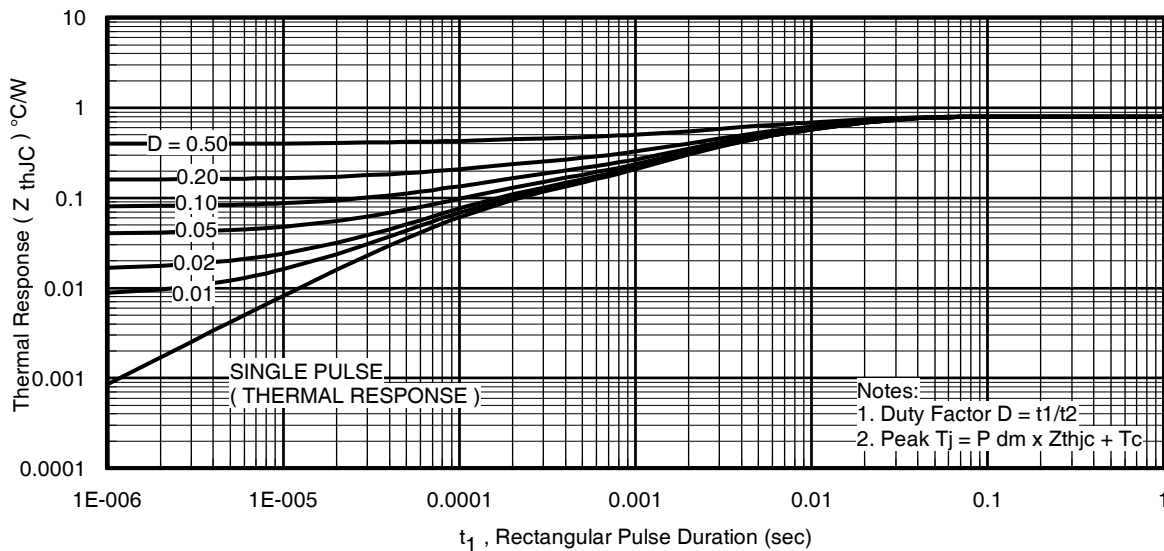
Fig 2. Typical Output Characteristics

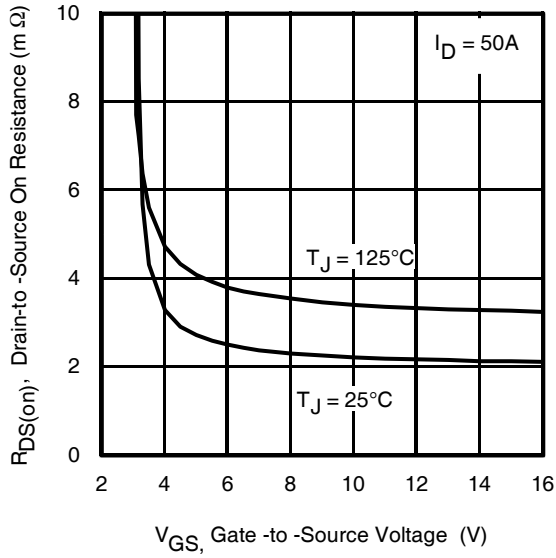
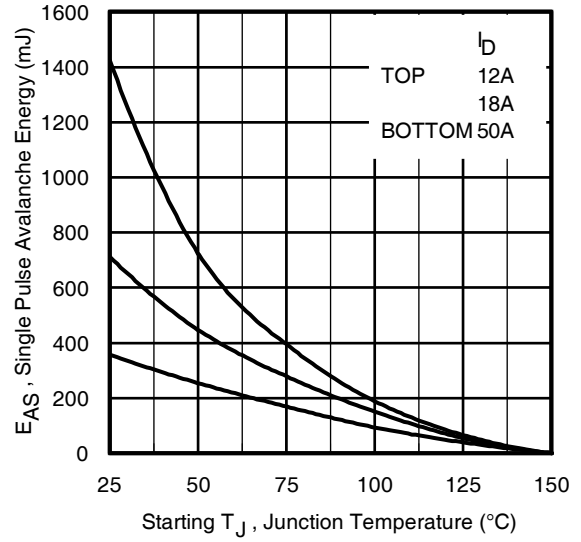
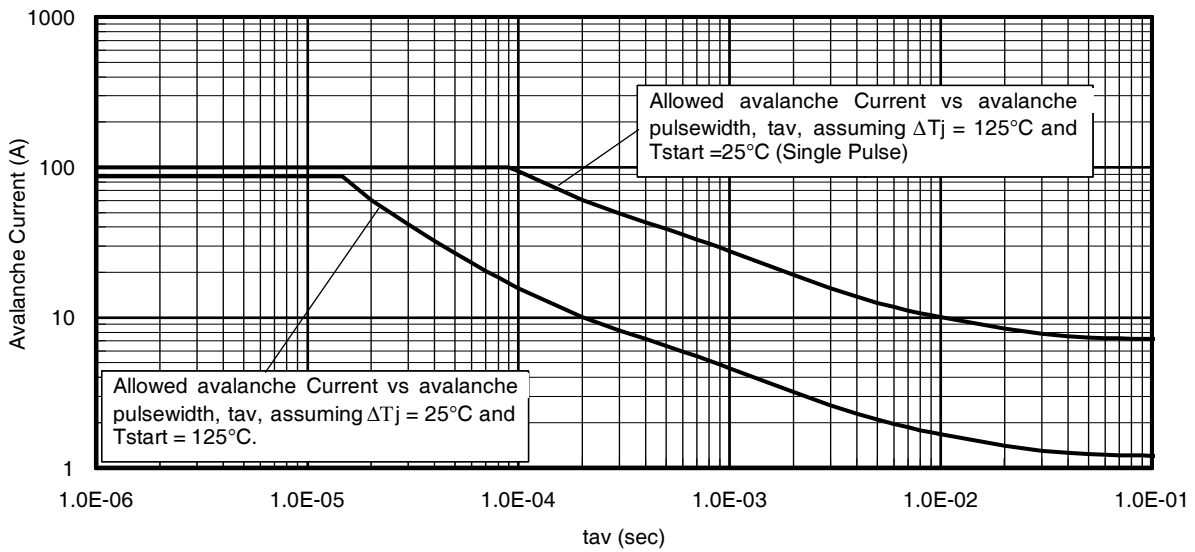
Fig 3. Typical Transfer Characteristics

Fig 4. Normalized On-Resistance vs. Temperature

Fig 5. Typical Capacitance vs. Drain-to-Source Voltage

Fig 6. Typical Gate Charge vs. Gate-to-Source Voltage

Fig 7. Typical Source-Drain Diode Forward Voltage

Fig 8. Maximum Safe Operating Area

Fig 9. Maximum Drain Current vs. Case Temperature

Fig 10. Threshold Voltage vs. Temperature

Fig 11. Maximum Effective Transient Thermal Impedance, Junction-to-Mounting Base

Fig 12. On-Resistance vs. Gate Voltage

Fig 13. Maximum Avalanche Energy vs. Drain Current

Fig 14. Typical Avalanche Current vs. Pulsewidth

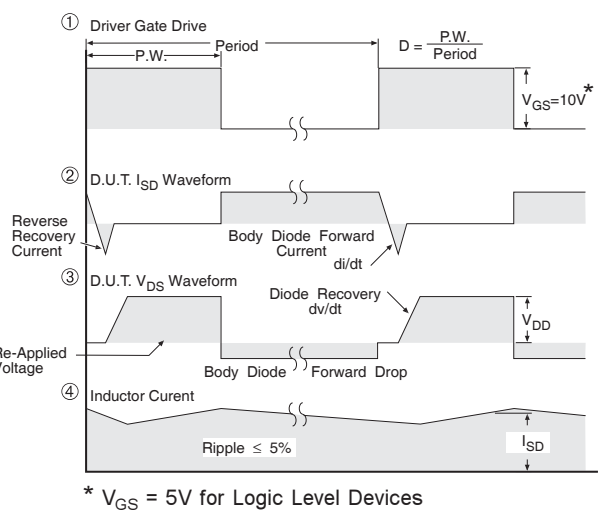
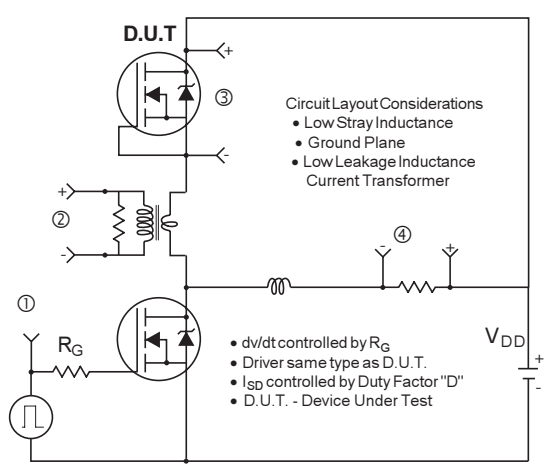

Fig 15. Peak Diode Recovery dv/dt Test Circuit for N-Channel HEXFET® Power MOSFETs

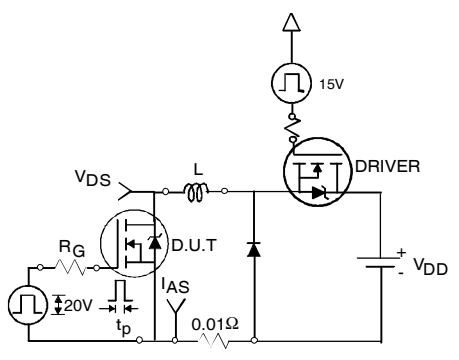

Fig 16a. Unclamped Inductive Test Circuit

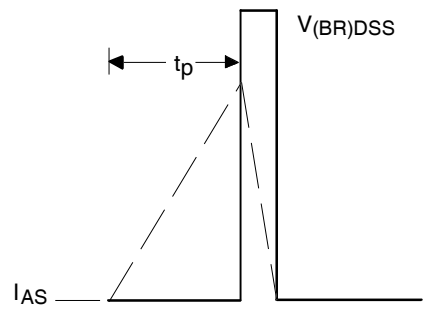

Fig 16b. Unclamped Inductive Waveforms

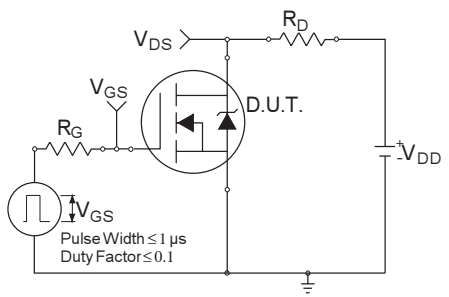

Fig 17a. Switching Time Test Circuit

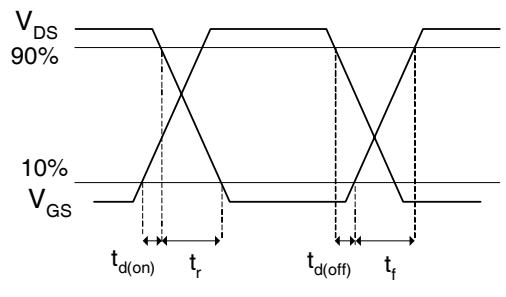

Fig 17b. Switching Time Waveforms

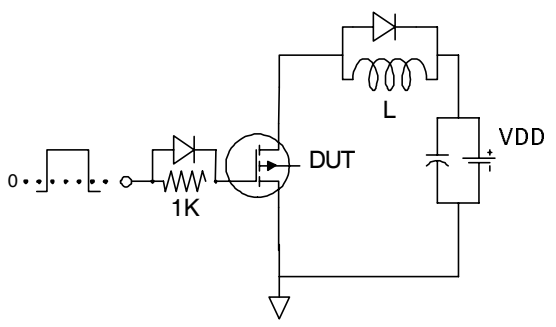

Fig 18a. Gate Charge Test Circuit

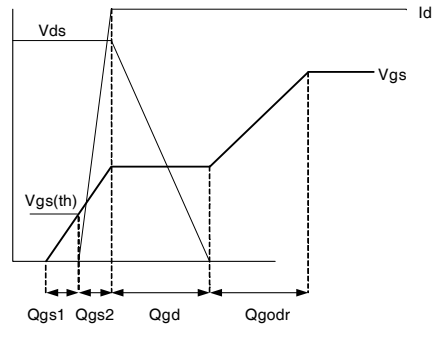
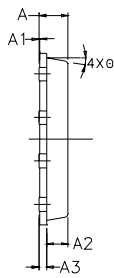
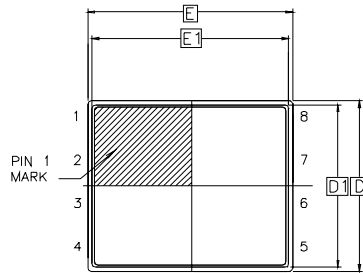

Fig 18b. Gate Charge Waveform

PQFN 5x6 Outline "B" Package Details



SIDE VIEW



TOP VIEW

DIM SYMBOL	MIN	NOM	MAX
A	0.800	0.830	1.05
A1	0.000	0.020	0.050
A2	0.580	0.630	0.680
A3		0.254 REF	
Ø	0"	10"	12"
b	0.350	0.400	0.470
D	4.850	5.000	5.150
D1	4.675	4.750	5.000
D2	3.700	4.210	4.300
e		1.270 BSC	
E	5.850	6.000	6.150
E1	5.675	5.750	6.000
E2	3.380	3.480	3.760
E4	2.480	2.580	2.680
L	0.550	0.800	0.900
R		0.200 REF	
R1		0.100 REF	
R2	0.150	0.200	0.250

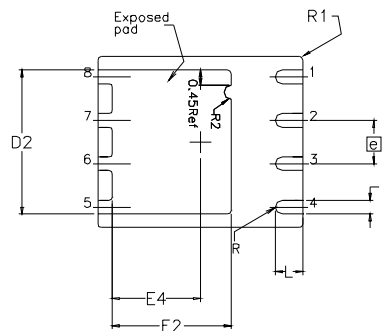

BOTTOM VIEW

For more information on board mounting, including footprint and stencil recommendation, please refer to application note AN-1136:

<http://www.irf.com/technical-info/appnotes/an-1136.pdf>

For more information on package inspection techniques, please refer to application note AN-1154:

<http://www.irf.com/technical-info/appnotes/an-1154.pdf>

PQFN 5x6 Outline "B" Part Marking

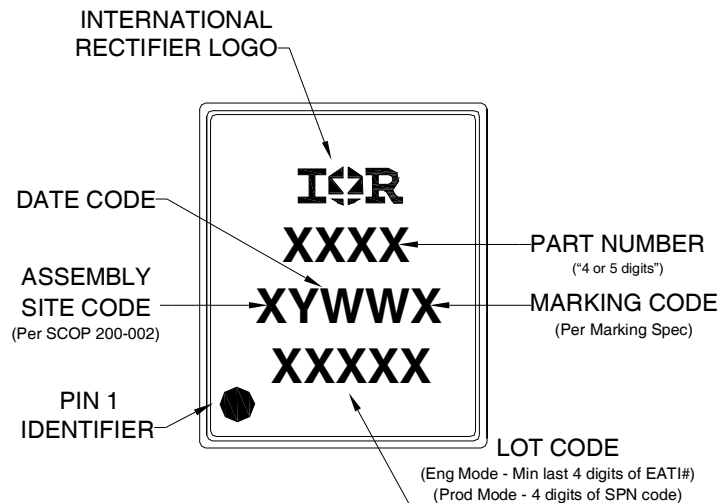

Note: For the most current drawing please refer to IR website at: <http://www.irf.com/package/>

PQFN 5x6 Outline "B" Tape and Reel

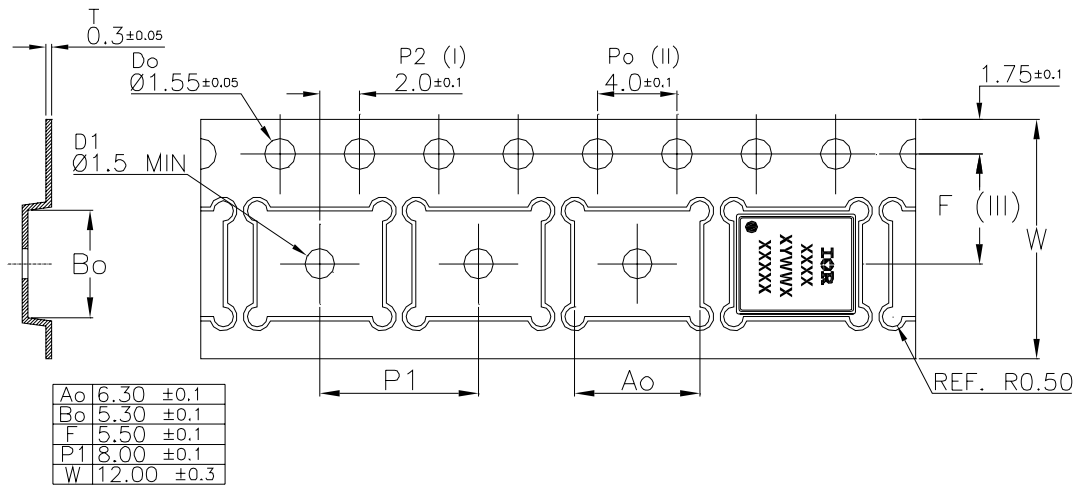

Qualification information[†]

Qualification level	Industrial ^{††} (per JEDEC JESD47F ^{†††} guidelines)	
Moisture Sensitivity Level	PQFN 5mm x 6mm	MSL1 (per JEDEC J-STD-020D ^{†††})
RoHS compliant	Yes	

[†] Qualification standards can be found at International Rectifier's web site

<http://www.irf.com/product-info/reliability>

^{††} Higher qualification ratings may be available should the user have such requirements.

Please contact your International Rectifier sales representative for further information:

<http://www.irf.com/whoto-call/salesrep/>

^{†††} Applicable version of JEDEC standard at the time of product release.

Notes:

- ① Repetitive rating; pulse width limited by max. junction temperature.
- ② Starting $T_J = 25^\circ\text{C}$, $L = 0.29\text{mH}$, $R_G = 50\Omega$, $I_{AS} = 50\text{A}$.
- ③ Pulse width $\leq 400\mu\text{s}$; duty cycle $\leq 2\%$.
- ④ R_θ is measured at T_J of approximately 90°C .
- ⑤ When mounted on 1 inch square 2 oz copper pad on 1.5x1.5 in. board of FR-4 material.
- ⑥ Calculated continuous current based on maximum allowable junction temperature. Package is limited to 100A by production test capability.