

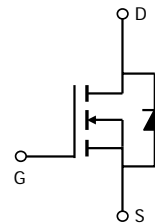
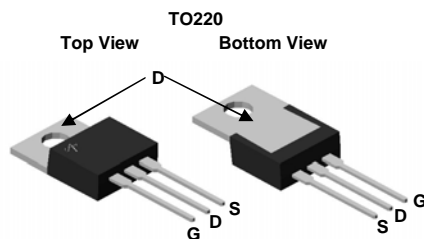
### General Description

The AOT416 is fabricated with SDMOS™ trench technology that combines excellent  $R_{DS(ON)}$  with low gate charge. The result is outstanding efficiency with controlled switching behavior. This universal technology is well suited for PWM, load switching and general purpose applications.

### Product Summary

$V_{DS}$	100V
$I_D$ (at $V_{GS}=10V$ )	42A
$R_{DS(ON)}$ (at $V_{GS}=10V$ )	< 37mΩ
$R_{DS(ON)}$ (at $V_{GS} = 7V$ )	< 43mΩ

100% UIS Tested  
 100%  $R_g$  Tested



### Absolute Maximum Ratings $T_A=25^\circ\text{C}$ unless otherwise noted

Parameter	Symbol	Maximum	Units
Drain-Source Voltage	$V_{DS}$	100	V
Gate-Source Voltage	$V_{GS}$	±25	V
Continuous Drain Current	$I_D$	$T_C=25^\circ\text{C}$	42
		$T_C=100^\circ\text{C}$	30
Pulsed Drain Current <sup>C</sup>	$I_{DM}$	110	A
Continuous Drain Current	$I_{DSM}$	$T_A=25^\circ\text{C}$	4.7
		$T_A=70^\circ\text{C}$	3.8
Avalanche Current <sup>C</sup>	$I_{AS}, I_{AR}$	28	A
Avalanche energy $L=0.1\text{mH}$ <sup>C</sup>	$E_{AS}, E_{AR}$	39	mJ
Power Dissipation <sup>B</sup>	$P_D$	$T_C=25^\circ\text{C}$	150
		$T_C=100^\circ\text{C}$	75
Power Dissipation <sup>A</sup>	$P_{DSM}$	$T_A=25^\circ\text{C}$	1.92
		$T_A=70^\circ\text{C}$	1.23
Junction and Storage Temperature Range	$T_J, T_{STG}$	-55 to 175	°C

### Thermal Characteristics

Parameter	Symbol	Typ	Max	Units
Maximum Junction-to-Ambient <sup>A</sup>	$R_{\theta JA}$	11.6	13.9	°C/W
Maximum Junction-to-Ambient <sup>A D</sup>				
Maximum Junction-to-Case	$R_{\theta JC}$	0.7	1	°C/W

**Electrical Characteristics (T<sub>J</sub>=25°C unless otherwise noted)**

Symbol	Parameter	Conditions	Min	Typ	Max	Units
<b>STATIC PARAMETERS</b>						
BV <sub>DSS</sub>	Drain-Source Breakdown Voltage	I <sub>D</sub> =250μA, V <sub>GS</sub> =0V	100			V
I <sub>DSS</sub>	Zero Gate Voltage Drain Current	V <sub>DS</sub> =100V, V <sub>GS</sub> =0V T <sub>J</sub> =55°C			10 50	μA
I <sub>GSS</sub>	Gate-Body leakage current	V <sub>DS</sub> =0V, V <sub>GS</sub> = ±25V			100	nA
V <sub>GS(th)</sub>	Gate Threshold Voltage	V <sub>DS</sub> =V <sub>GS</sub> I <sub>D</sub> =250μA	2.8	3.4	4	V
I <sub>D(ON)</sub>	On state drain current	V <sub>GS</sub> =10V, V <sub>DS</sub> =5V	110			A
R <sub>DS(ON)</sub>	Static Drain-Source On-Resistance	V <sub>GS</sub> =10V, I <sub>D</sub> =20A T <sub>J</sub> =125°C		31	37	mΩ
				55	66	
		V <sub>GS</sub> =7V, I <sub>D</sub> =15A		35	43	mΩ
g <sub>FS</sub>	Forward Transconductance	V <sub>DS</sub> =5V, I <sub>D</sub> =20A		28		S
V <sub>SD</sub>	Diode Forward Voltage	I <sub>S</sub> =1A, V <sub>GS</sub> =0V		0.68	1	V
I <sub>S</sub>	Maximum Body-Diode Continuous Current				95	A
<b>DYNAMIC PARAMETERS</b>						
C <sub>iss</sub>	Input Capacitance	V <sub>GS</sub> =0V, V <sub>DS</sub> =50V, f=1MHz	950	1180	1450	pF
C <sub>oss</sub>	Output Capacitance		77	110	145	pF
C <sub>rss</sub>	Reverse Transfer Capacitance		21	36	50	pF
R <sub>g</sub>	Gate resistance	V <sub>GS</sub> =0V, V <sub>DS</sub> =0V, f=1MHz	0.4	0.8	1.2	Ω
<b>SWITCHING PARAMETERS</b>						
Q <sub>g</sub>	Total Gate Charge	V <sub>GS</sub> =10V, V <sub>DS</sub> =50V, I <sub>D</sub> =20A	15	19	23	nC
Q <sub>gs</sub>	Gate Source Charge		5.5	7	8.5	nC
Q <sub>gd</sub>	Gate Drain Charge		3.5	6.3	9	nC
t <sub>D(on)</sub>	Turn-On Delay Time	V <sub>GS</sub> =10V, V <sub>DS</sub> =50V, R <sub>L</sub> =2.5Ω, R <sub>GEN</sub> =3Ω		10		ns
t <sub>r</sub>	Turn-On Rise Time			7.2		ns
t <sub>D(off)</sub>	Turn-Off Delay Time			15		ns
t <sub>f</sub>	Turn-Off Fall Time			7		ns
t <sub>rr</sub>	Body Diode Reverse Recovery Time		I <sub>F</sub> =20A, dI/dt=500A/μs	13	19	25
Q <sub>rr</sub>	Body Diode Reverse Recovery Charge	I <sub>F</sub> =20A, dI/dt=500A/μs	50	70	90	nC

A. The value of R<sub>θJA</sub> is measured with the device mounted on 1 in<sup>2</sup> FR-4 board with 2oz. Copper, in a still air environment with T<sub>A</sub>=25°C. The Power dissipation P<sub>D(SM)</sub> is based on R<sub>θJA</sub> and the maximum allowed junction temperature of 150°C. The value in any given application depends on the user's specific board design, and the maximum temperature of 175°C may be used if the PCB allows it.

B. The power dissipation P<sub>D</sub> is based on T<sub>J(MAX)</sub>=175°C, using junction-to-case thermal resistance, and is more useful in setting the upper dissipation limit for cases where additional heatsinking is used.

C. Repetitive rating, pulse width limited by junction temperature T<sub>J(MAX)</sub>=175°C. Ratings are based on low frequency and duty cycles to keep initial T<sub>J</sub>=25°C.

D. The R<sub>θJA</sub> is the sum of the thermal impedance from junction to case R<sub>θJC</sub> and case to ambient.

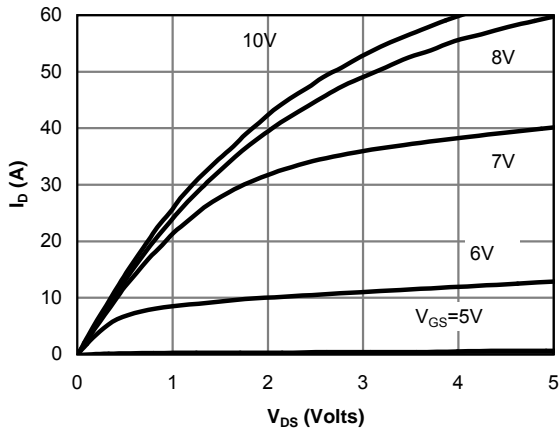
E. The static characteristics in Figures 1 to 6 are obtained using <300 μs pulses, duty cycle 0.5% max.

F. These curves are based on the junction-to-case thermal impedance which is measured with the device mounted to a large heatsink, assuming a maximum junction temperature of T<sub>J(MAX)</sub>=175°C. The SOA curve provides a single pulse rating.

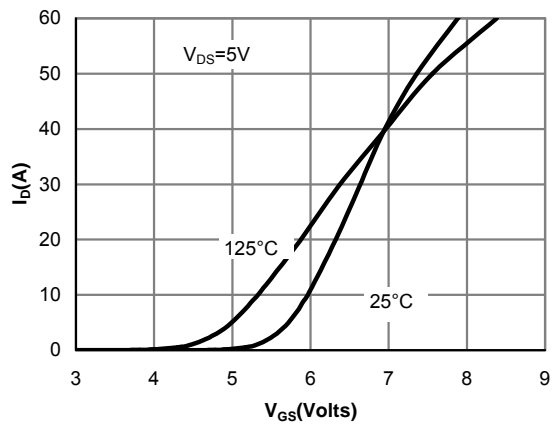
G. These tests are performed with the device mounted on 1 in<sup>2</sup> FR-4 board with 2oz. Copper, in a still air environment with T<sub>A</sub>=25°C.

COMPONENTS IN LIFE SUPPORT DEVICES OR SYSTEMS ARE NOT AUTHORIZED. AOS DOES NOT ASSUME ANY LIABILITY ARISING OUT OF SUCH APPLICATIONS OR USES OF ITS PRODUCTS. AOS RESERVES THE RIGHT TO IMPROVE PRODUCT DESIGN, FUNCTIONS AND RELIABILITY WITHOUT NOTICE.

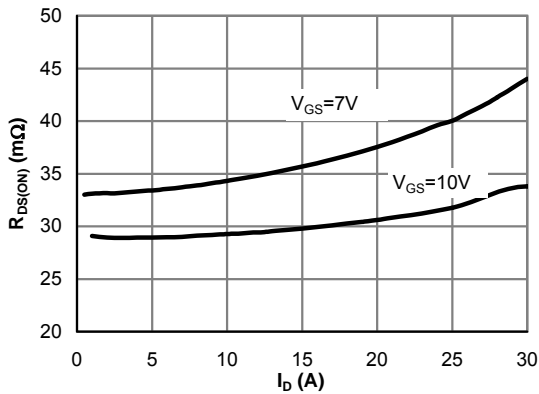
**TYPICAL ELECTRICAL AND THERMAL CHARACTERISTICS**



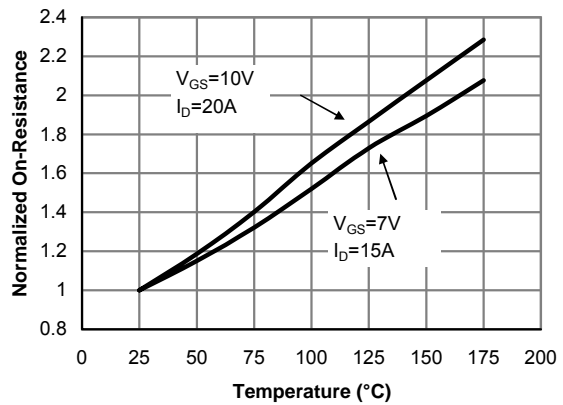
**Figure 1: On-Region Characteristics (Note E)**



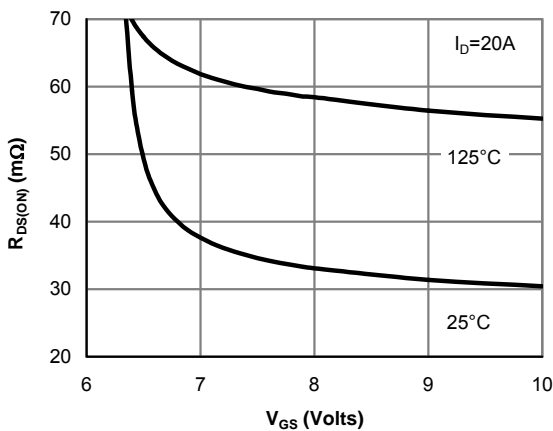
**Figure 2: Transfer Characteristics (Note E)**



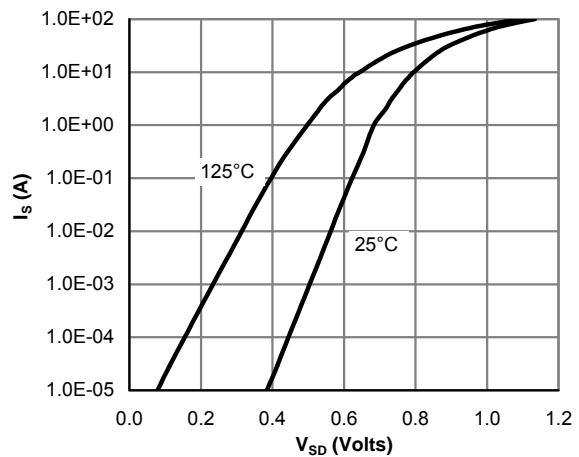
**Figure 3: On-Resistance vs. Drain Current and Gate Voltage (Note E)**



**Figure 4: On-Resistance vs. Junction Temperature (Note E)**

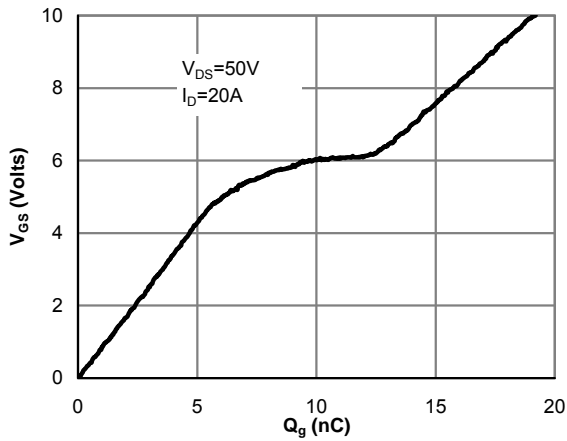


**Figure 5: On-Resistance vs. Gate-Source Voltage (Note E)**

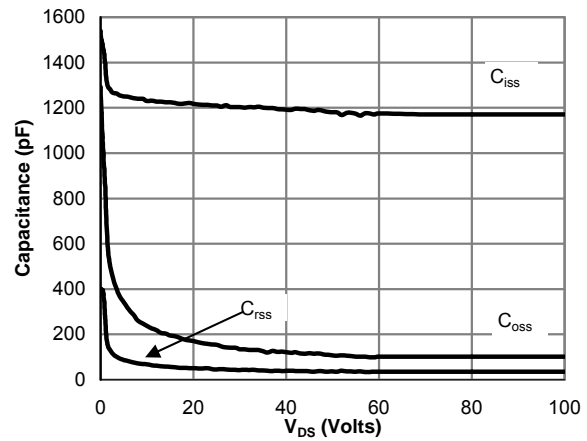


**Figure 6: Body-Diode Characteristics (Note E)**

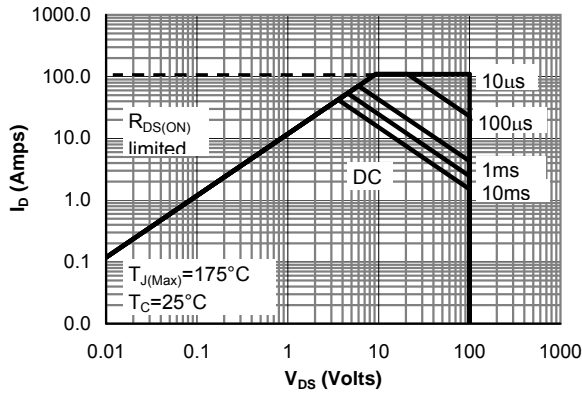
**TYPICAL ELECTRICAL AND THERMAL CHARACTERISTICS**



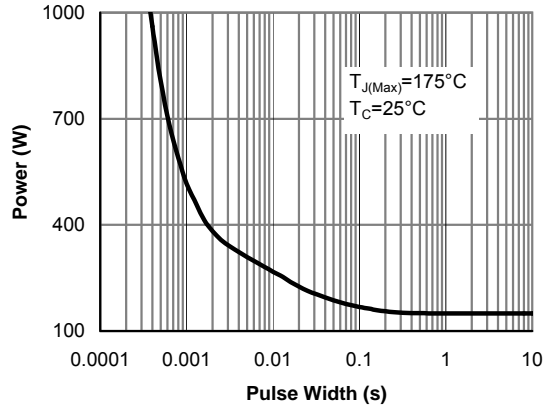
**Figure 7: Gate-Charge Characteristics**



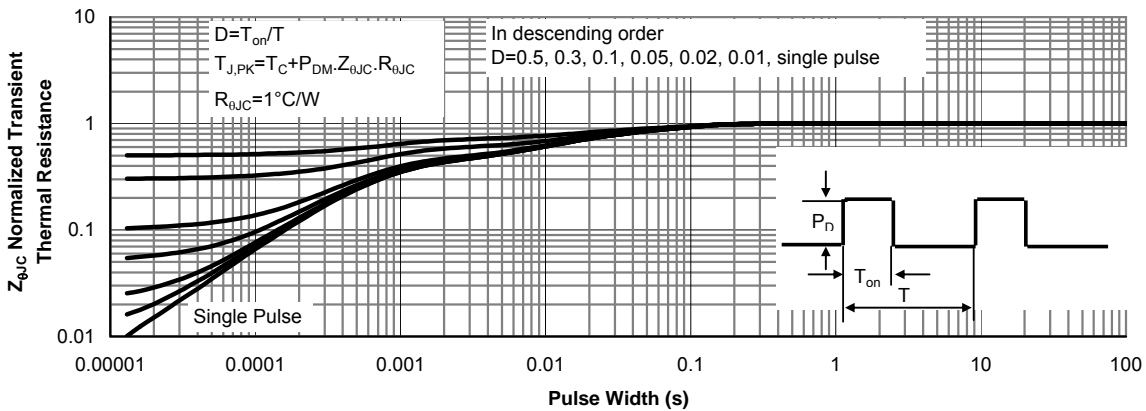
**Figure 8: Capacitance Characteristics**



**Figure 9: Maximum Forward Biased Safe Operating Area (Note F)**

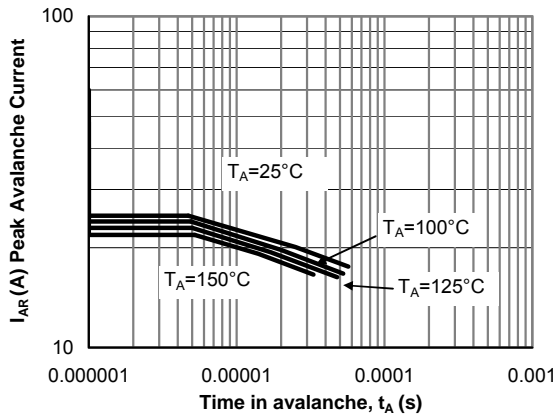


**Figure 10: Single Pulse Power Rating Junction-to-Case (Note F)**

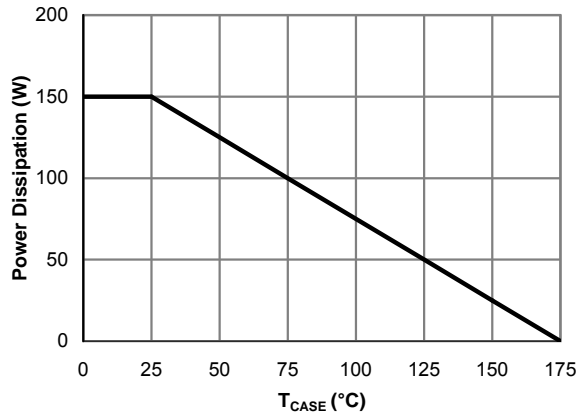


**Figure 11: Normalized Maximum Transient Thermal Impedance (Note F)**

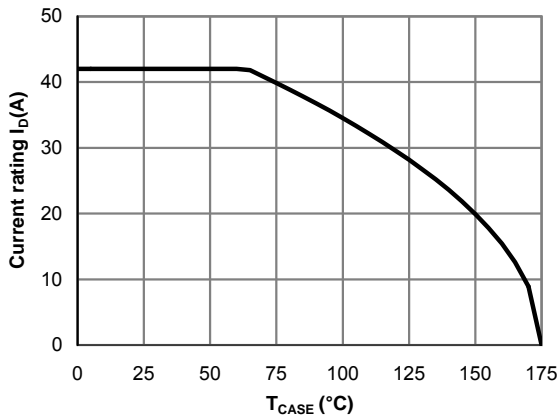
**TYPICAL ELECTRICAL AND THERMAL CHARACTERISTICS**



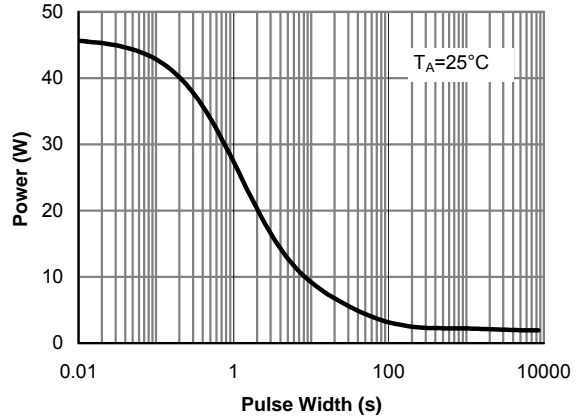
**Figure 12: Single Pulse Avalanche capability (Note C)**



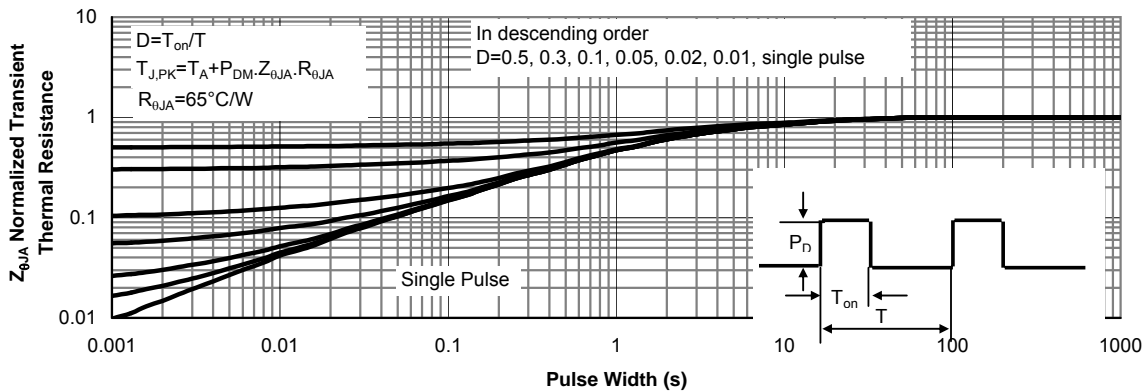
**Figure 13: Power De-rating (Note F)**



**Figure 14: Current De-rating (Note F)**

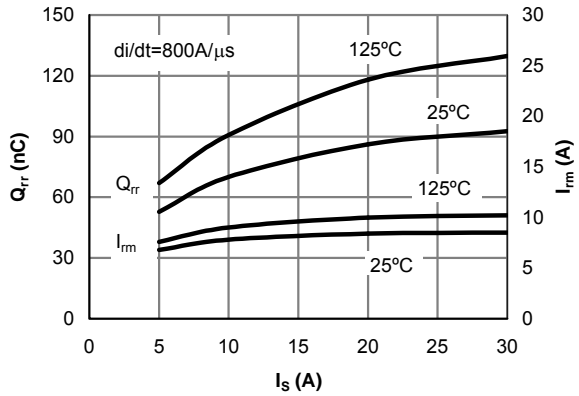


**Figure 15: Single Pulse Power Rating Junction-to-Ambient (Note G)**

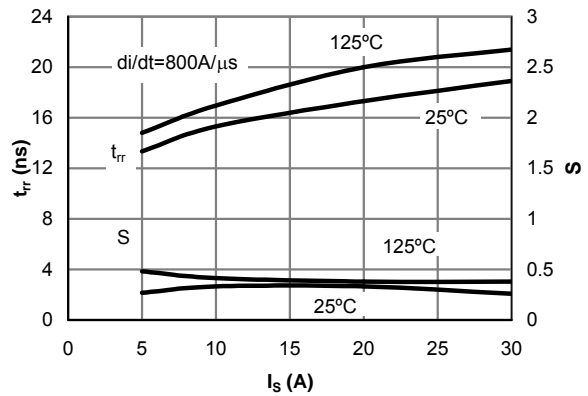


**Figure 16: Normalized Maximum Transient Thermal Impedance (Note G)**

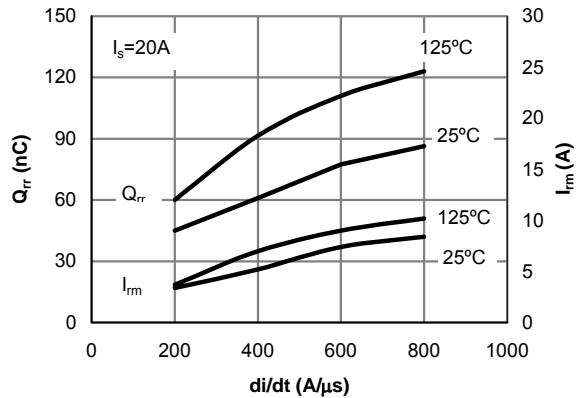
**TYPICAL ELECTRICAL AND THERMAL CHARACTERISTICS**



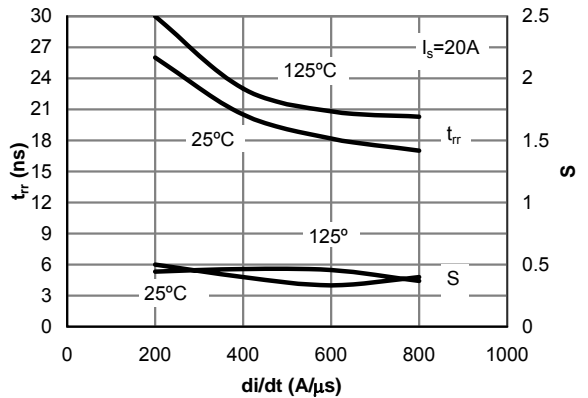
**Figure 17: Diode Reverse Recovery Charge and Peak Current vs. Conduction Current**



**Figure 18: Diode Reverse Recovery Time and Softness Factor vs. Conduction Current**

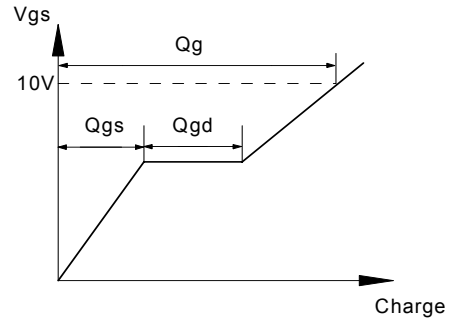
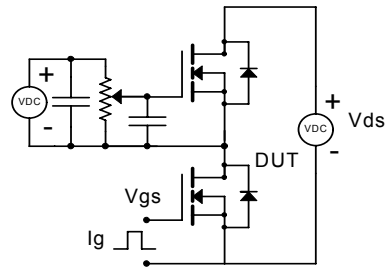


**Figure 19: Diode Reverse Recovery Charge and Peak Current vs. di/dt**

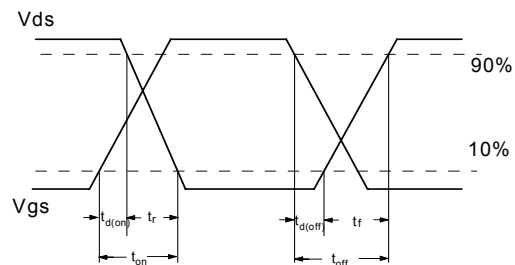
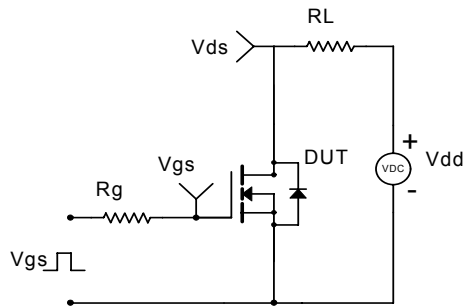


**Figure 20: Diode Reverse Recovery Time and Softness Factor vs. di/dt**

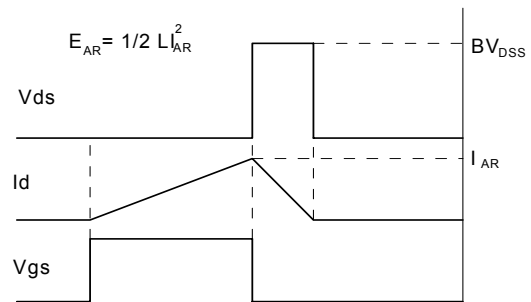
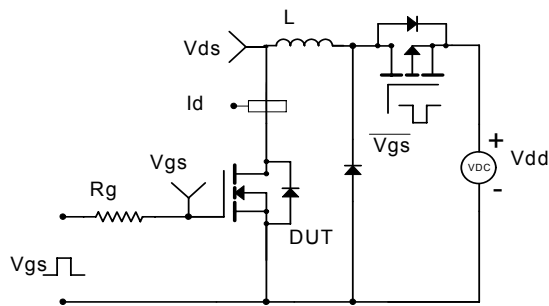
**Gate Charge Test Circuit & Waveform**



**Resistive Switching Test Circuit & Waveforms**



**Unclamped Inductive Switching (UIS) Test Circuit & Waveforms**



**Diode Recovery Test Circuit & Waveforms**

