



# STB185N55F3 STP185N55F3

N-channel 55V - 3.2mΩ - 120A - D<sup>2</sup>PAK/TO-220  
STripFET™ Power MOSFET

## Features

Type	V <sub>DSS</sub>	R <sub>DS(on)</sub>	I <sub>D</sub>	P <sub>w</sub>
STB185N55F3	55V	3.5mΩ	120A <sup>(1)</sup>	330W
STP185N55F3	55V	3.8mΩ	120A <sup>(1)</sup>	330W

1. Value limited by wire bonding

- Ultra low on-resistance
- 100% avalanche tested

## Description

This n-channel enhancement mode Power MOSFET is the latest refinement of STMicroelectronics unique “single feature size™” strip-based process with less critical alignment steps and therefore a remarkable manufacturing reproducibility. The resulting transistor shows extremely high packing density for low on resistance, rugged avalanche characteristics and low gate charge.

## Applications

- Switching applications
  - Automotive

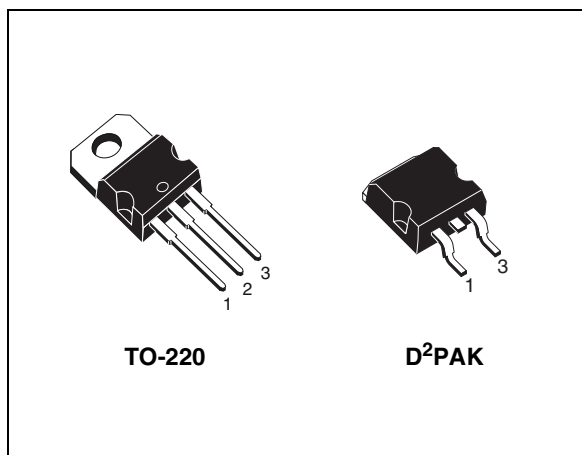

Figure 1. Internal schematic diagram

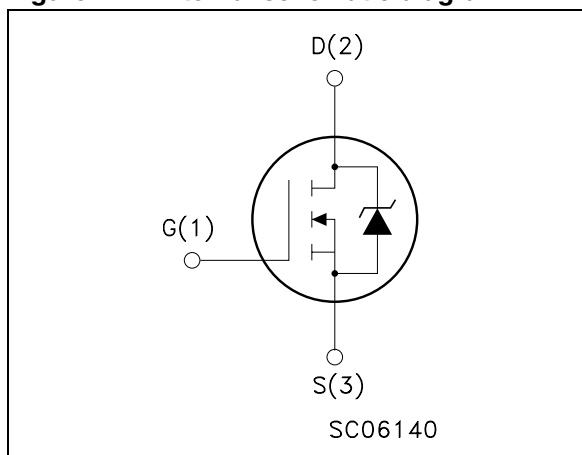

Table 1. Device summary

Order codes	Marking	Package	Packaging
STB185N55F3	185N55F3	D <sup>2</sup> PAK	Tape & reel
STP185N55F3	185N55F3	TO-220	Tube

# Contents

<b>1</b>	<b>Electrical ratings</b> .....	<b>3</b>
<b>2</b>	<b>Electrical characteristics</b> .....	<b>4</b>
2.1	Electrical characteristics (curves) .....	6
<b>3</b>	<b>Test circuit</b> .....	<b>8</b>
<b>4</b>	<b>Package mechanical data</b> .....	<b>9</b>
<b>5</b>	<b>Packaging mechanical data</b> .....	<b>12</b>
<b>6</b>	<b>Revision history</b> .....	<b>13</b>

# 1 Electrical ratings

**Table 1. Absolute maximum ratings**

Symbol	Parameter	Value	Unit
$V_{DS}$	Drain-source voltage ( $V_{GS}=0$ )	55	V
$V_{GS}$	Gate-source voltage	$\pm 20$	V
$I_D^{(1)}$	Drain current (continuous) at $T_C = 25^\circ\text{C}$	120	A
$I_D^{(1)}$	Drain current (continuous) at $T_C=100^\circ\text{C}$	120	A
$I_{DM}^{(2)}$	Drain current (pulsed)	480	A
$P_{TOT}$	Total dissipation at $T_C = 25^\circ\text{C}$	330	W
	Derating factor	2.2	W/ $^\circ\text{C}$
$dv/dt^{(3)}$	Peak diode recovery voltage slope	10	V/ns
$E_{AS}^{(4)}$	Single pulse avalanche energy	1000	mJ
$T_j$ $T_{stg}$	Operating junction temperature storage temperature	-55 To 175	$^\circ\text{C}$

1. Current limited by package.
2. Pulse width limited by safe operating area.
3.  $I_{SD} \leq 120\text{A}$ ,  $di/dt \leq 900\text{A}/\mu\text{s}$ ,  $V_{DD} \leq V_{(BR)DSS}$ ,  $T_J \leq T_{JMAX}$
4. Starting  $T_j=25^\circ\text{C}$ ,  $I_d=60\text{A}$ ,  $V_{dd}=40\text{V}$  (see Figure 16 and Figure 17)

**Table 2. Thermal data**

		TO-220	D <sup>2</sup> PAK	Unit
$R_{thj-case}$	Thermal resistance junction-case	0.45		$^\circ\text{C}/\text{W}$
$R_{thj-a}$	Thermal resistance junction-ambient max	62.5	--	$^\circ\text{C}/\text{W}$
$R_{thj-pcb}^{(1)}$	Thermal resistance junction-ambient max	--	50	$^\circ\text{C}/\text{W}$
$T_l$	Maximum lead temperature for soldering purpose	300		$^\circ\text{C}$

1. When mounted on 1 inch<sup>2</sup> FR4 2oz Cu.

## 2 Electrical characteristics

( $T_{CASE}=25^{\circ}C$  unless otherwise specified)

**Table 3. On/off states**

Symbol	Parameter	Test conditions	Min.	Typ.	Max.	Unit
$V_{(BR)DSS}$	Drain-source breakdown voltage	$I_D = 250\mu A, V_{GS} = 0$	55			V
$I_{DSS}$	Zero gate voltage drain current ( $V_{GS} = 0$ )	$V_{DS} = \text{max rating},$ $V_{DS} = \text{max rating}, @ 125^{\circ}C$			10 100	$\mu A$ $\mu A$
$I_{GSS}$	Gate body leakage current ( $V_{DS} = 0$ )	$V_{GS} = \pm 20V$			$\pm 200$	nA
$V_{GS(th)}$	Gate threshold voltage	$V_{DS} = V_{GS}, I_D = 250\mu A$	2		4	V
$R_{DS(on)}$	Static drain-source on resistance	$V_{GS} = 10V, I_D = 60A$ <b>D<sup>2</sup>PAK</b> <b>TO-220</b>		2.9 3.2	3.5 3.8	$m\Omega$ $m\Omega$

**Table 4. Dynamic**

Symbol	Parameter	Test conditions	Min.	Typ.	Max.	Unit
$g_{fs}^{(1)}$	Forward transconductance	$V_{DS} = 15V, I_D = 60A$		150		S
$C_{iss}$ $C_{oss}$ $C_{rss}$	Input capacitance Output capacitance Reverse transfer capacitance	$V_{DS} = 25V, f = 1MHz,$ $V_{GS} = 0$		6800 1450 15		pF pF pF
$t_{d(on)}$ $t_r$ $t_{d(off)}$ $t_f$	Turn-on delay time Rise time Turn-off delay time Fall time	$V_{DD} = 27.5V, I_D = 60A$ $R_G = 4.7\Omega, V_{GS} = 10V$ <i>(see Figure 13,</i> <i>Figure 18)</i>		25 150 110 50		ns ns ns ns
$Q_g$ $Q_{gs}$ $Q_{gd}$	Total gate charge Gate-source charge Gate-drain charge	$V_{DD} = 44V, I_D = 120A,$ $V_{GS} = 10V,$ <i>(see Figure 14)</i>		100 30 26		nC nC nC

1. Pulsed: Pulse duration = 300  $\mu s$ , duty cycle 1.5%.

**Table 5. Source drain diode**

Symbol	Parameter	Test conditions	Min.	Typ.	Max.	Unit
$I_{SD}$ $I_{SDM}^{(1)}$	Source-drain current Source-drain current (pulsed)				120 480	A A
$V_{SD}^{(2)}$	Forward on voltage	$I_{SD}=120A, V_{GS}=0$			1.5	V
$t_{rr}$ $Q_{rr}$ $I_{RRM}$	Reverse recovery time Reverse recovery charge Reverse recovery current	$I_{SD}=120A,$ $di/dt = 100A/\mu s,$ $V_{DD}=35V, T_j=150^\circ C$ (see <a href="#">Figure 15</a> )		60 0.11 3.5		ns $\mu C$ A

1. Pulse width limited by safe operating area
2. Pulsed: pulse duration = 300 $\mu s$ , duty cycle 1.5%

## 2.1 Electrical characteristics (curves)

Figure 2. Safe operating area

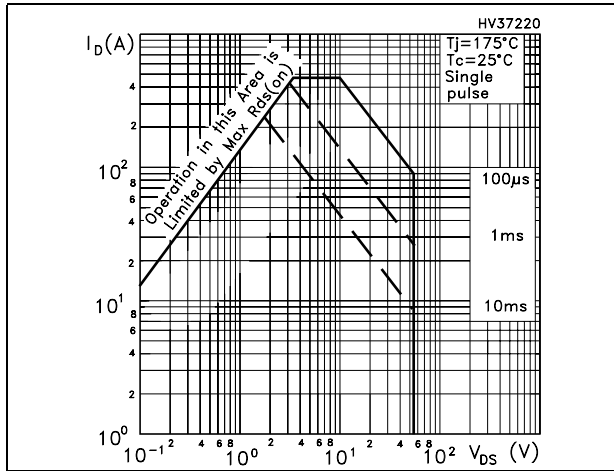

Figure 3. Thermal impedance

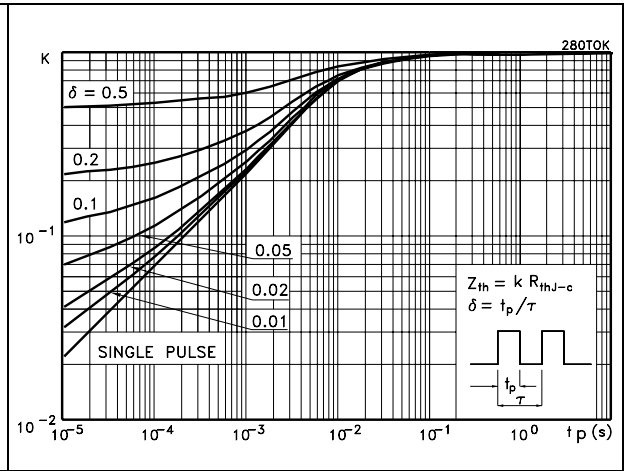

Figure 4. Output characteristics

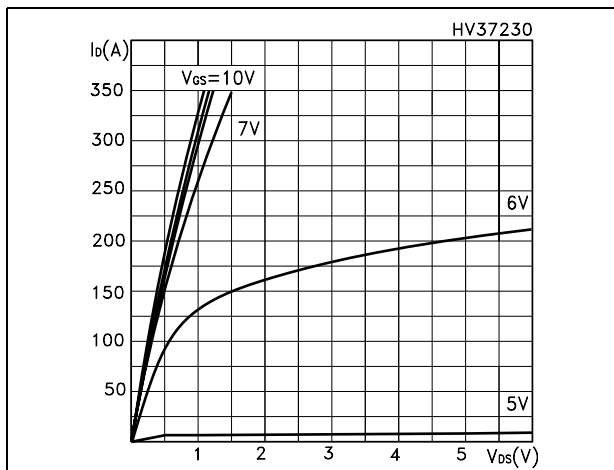

Figure 5. Transfer characteristics

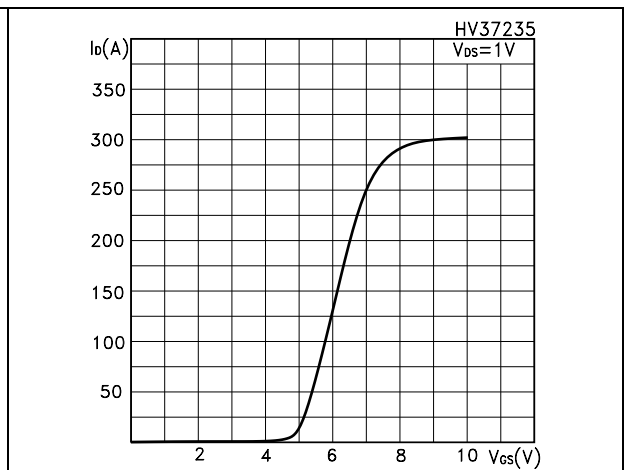

Figure 6. Normalized  $B_{V_{DS}}$  vs temperature

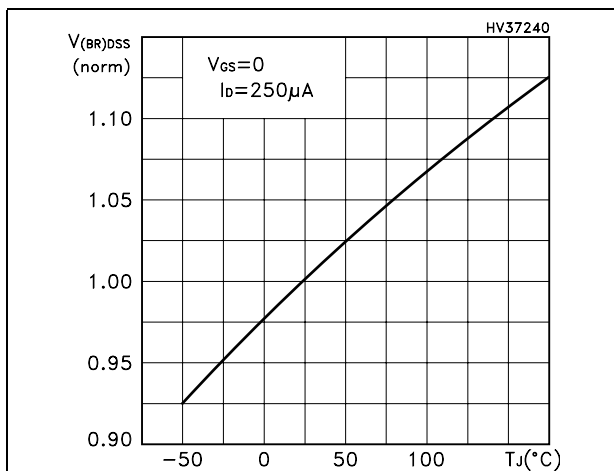

Figure 7. Static drain-source on resistance

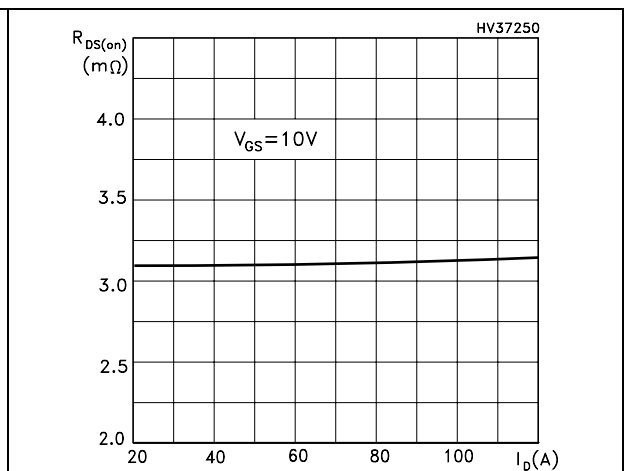

Figure 8. Gate charge vs gate-source voltage Figure 9. Capacitance variations

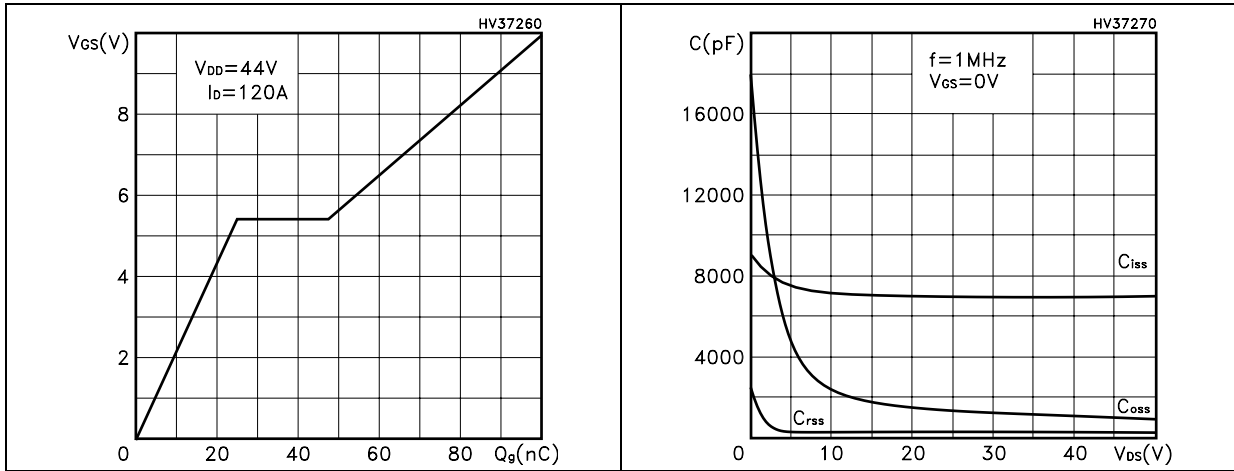

Figure 10. Normalized gate threshold voltage vs temperature

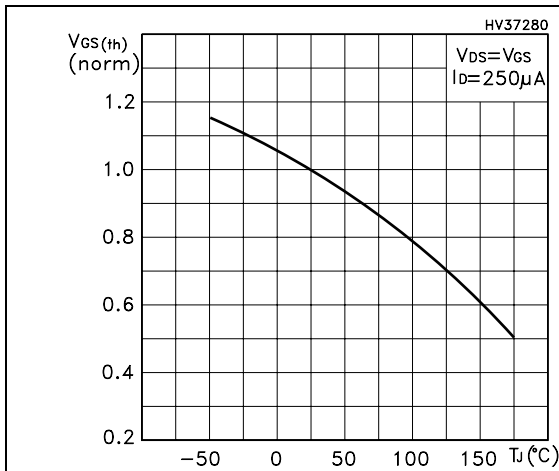

Figure 11. Normalized on resistance vs temperature

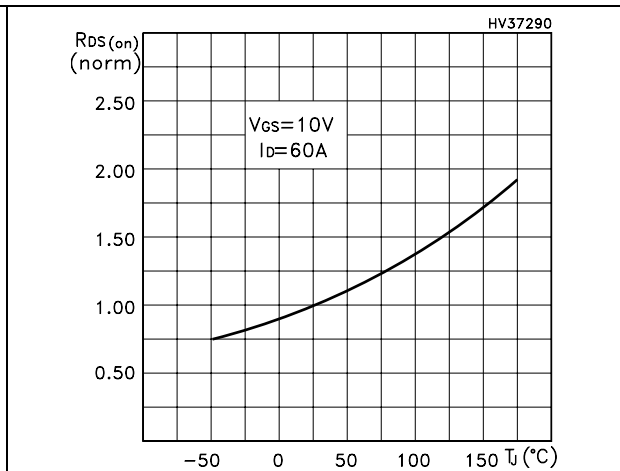
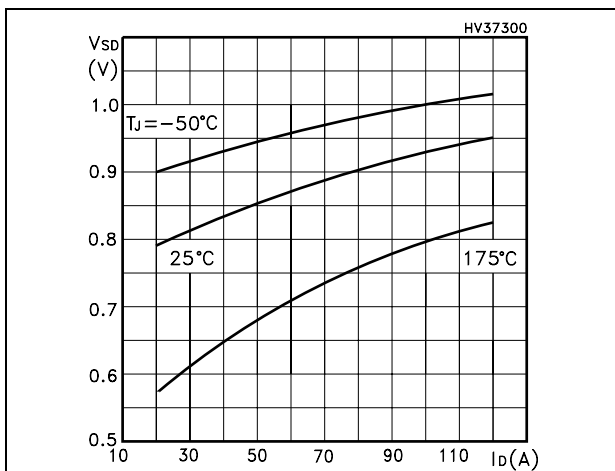

Figure 12. Source-drain diode forward characteristics



### 3 Test circuit

Figure 13. Switching times test circuit for resistive load



Figure 14. Gate charge test circuit



Figure 15. Test circuit for inductive load switching and diode recovery times



Figure 16. Unclamped Inductive load test circuit



Figure 17. Unclamped inductive waveform



Figure 18. Switching time waveform





## 4 Package mechanical data

In order to meet environmental requirements, ST offers these devices in ECOPACK® packages. These packages have a Lead-free second level interconnect. The category of second level interconnect is marked on the package and on the inner box label, in compliance with JEDEC Standard JESD97. The maximum ratings related to soldering conditions are also marked on the inner box label. ECOPACK is an ST trademark. ECOPACK specifications are available at: [www.st.com](http://www.st.com)

**D<sup>2</sup>PAK MECHANICAL DATA**

DIM.	mm.			inch		
	MIN.	TYP.	MAX.	MIN.	TYP.	MAX.
A	4.4		4.6	0.173		0.181
A1	2.49		2.69	0.098		0.106
A2	0.03		0.23	0.001		0.009
B	0.7		0.93	0.027		0.036
B2	1.14		1.7	0.044		0.067
C	0.45		0.6	0.017		0.023
C2	1.23		1.36	0.048		0.053
D	8.95		9.35	0.352		0.368
D1		8			0.315	
E	10		10.4	0.393		
E1		8.5			0.334	
G	4.88		5.28	0.192		0.208
L	15		15.85	0.590		0.625
L2	1.27		1.4	0.050		0.055
L3	1.4		1.75	0.055		0.068
M	2.4		3.2	0.094		0.126
R		0.4			0.015	
V2	0°		4°			

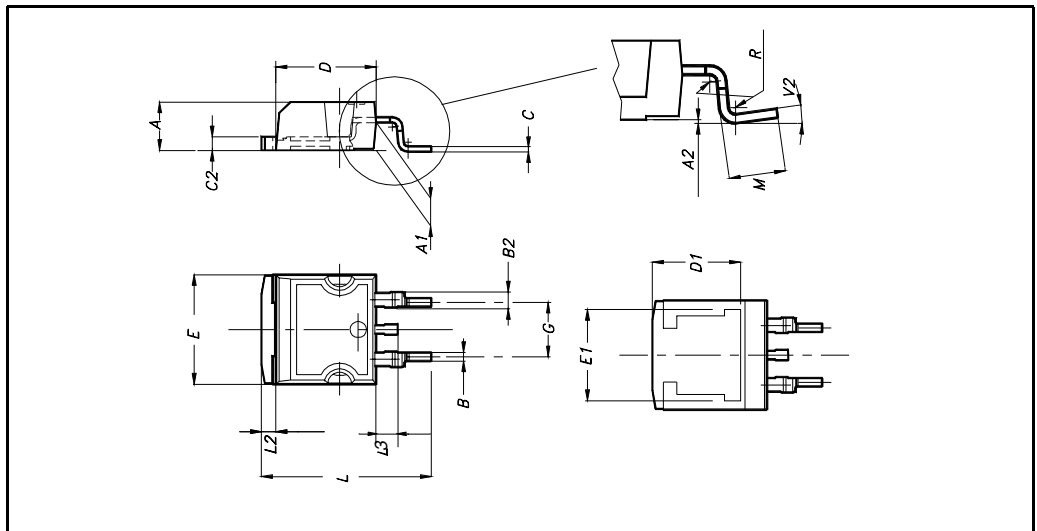

TO-220 mechanical data

Dim	mm			inch		
	Min	Typ	Max	Min	Typ	Max
A	4.40		4.60	0.173		0.181
b	0.61		0.88	0.024		0.034
b1	1.14		1.70	0.044		0.066
c	0.49		0.70	0.019		0.027
D	15.25		15.75	0.6		0.62
D1		1.27			0.050	
E	10		10.40	0.393		0.409
e	2.40		2.70	0.094		0.106
e1	4.95		5.15	0.194		0.202
F	1.23		1.32	0.048		0.051
H1	6.20		6.60	0.244		0.256
J1	2.40		2.72	0.094		0.107
L	13		14	0.511		0.551
L1	3.50		3.93	0.137		0.154
L20		16.40			0.645	
L30		28.90			1.137	
∅P	3.75		3.85	0.147		0.151
Q	2.65		2.95	0.104		0.116

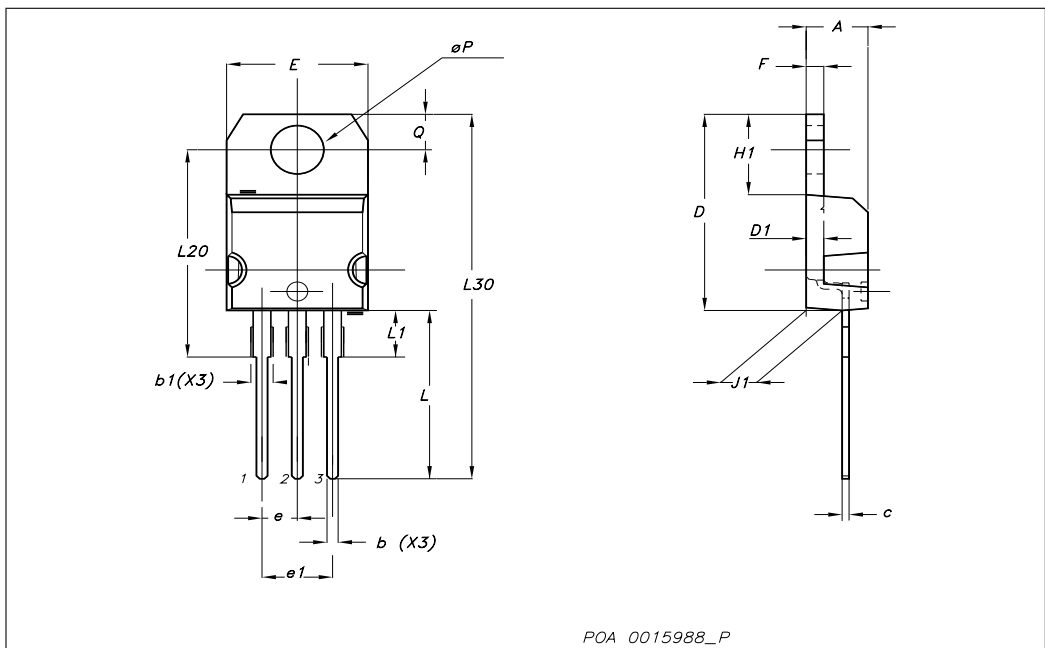

# 5 Packaging mechanical data

## D<sup>2</sup>PAK FOOTPRINT



## TAPE AND REEL SHIPMENT

**TAPE MECHANICAL DATA**

DIM.	mm		inch	
	MIN.	MAX.	MIN.	MAX.
A0	10.5	10.7	0.413	0.421
B0	15.7	15.9	0.618	0.626
D	1.5	1.6	0.059	0.063
D1	1.59	1.61	0.062	0.063
E	1.65	1.85	0.065	0.073
F	11.4	11.6	0.449	0.456
K0	4.8	5.0	0.189	0.197
P0	3.9	4.1	0.153	0.161
P1	11.9	12.1	0.468	0.476
P2	1.9	2.1	0.075	0.082
R	50		1.574	
T	0.25	0.35	0.0098	0.0137
W	23.7	24.3	0.933	0.956

**REEL MECHANICAL DATA**

DIM.	mm		inch	
	MIN.	MAX.	MIN.	MAX.
A		330		12.992
B	1.5		0.059	
C	12.8	13.2	0.504	0.520
D	20.2		0.795	
G	24.4	26.4	0.960	1.039
N	100		3.937	
T		30.4		1.197

BASE QTY	BULK QTY
1000	1000

10 pitches cumulative tolerance on tape +/- 0.2 mm

\* on sales type

## 6 Revision history

**Table 6. Revision history**

<b>Date</b>	<b>Revision</b>	<b>Changes</b>
31-Jan-2007	1	First version
28-Jun-2007	2	Complete version

**Please Read Carefully:**

Information in this document is provided solely in connection with ST products. STMicroelectronics NV and its subsidiaries ("ST") reserve the right to make changes, corrections, modifications or improvements, to this document, and the products and services described herein at any time, without notice.

All ST products are sold pursuant to ST's terms and conditions of sale.

Purchasers are solely responsible for the choice, selection and use of the ST products and services described herein, and ST assumes no liability whatsoever relating to the choice, selection or use of the ST products and services described herein.

No license, express or implied, by estoppel or otherwise, to any intellectual property rights is granted under this document. If any part of this document refers to any third party products or services it shall not be deemed a license grant by ST for the use of such third party products or services, or any intellectual property contained therein or considered as a warranty covering the use in any manner whatsoever of such third party products or services or any intellectual property contained therein.

**UNLESS OTHERWISE SET FORTH IN ST'S TERMS AND CONDITIONS OF SALE ST DISCLAIMS ANY EXPRESS OR IMPLIED WARRANTY WITH RESPECT TO THE USE AND/OR SALE OF ST PRODUCTS INCLUDING WITHOUT LIMITATION IMPLIED WARRANTIES OF MERCHANTABILITY, FITNESS FOR A PARTICULAR PURPOSE (AND THEIR EQUIVALENTS UNDER THE LAWS OF ANY JURISDICTION), OR INFRINGEMENT OF ANY PATENT, COPYRIGHT OR OTHER INTELLECTUAL PROPERTY RIGHT.**

**UNLESS EXPRESSLY APPROVED IN WRITING BY AN AUTHORIZED ST REPRESENTATIVE, ST PRODUCTS ARE NOT RECOMMENDED, AUTHORIZED OR WARRANTED FOR USE IN MILITARY, AIR CRAFT, SPACE, LIFE SAVING, OR LIFE SUSTAINING APPLICATIONS, NOR IN PRODUCTS OR SYSTEMS WHERE FAILURE OR MALFUNCTION MAY RESULT IN PERSONAL INJURY, DEATH, OR SEVERE PROPERTY OR ENVIRONMENTAL DAMAGE. ST PRODUCTS WHICH ARE NOT SPECIFIED AS "AUTOMOTIVE GRADE" MAY ONLY BE USED IN AUTOMOTIVE APPLICATIONS AT USER'S OWN RISK.**

Resale of ST products with provisions different from the statements and/or technical features set forth in this document shall immediately void any warranty granted by ST for the ST product or service described herein and shall not create or extend in any manner whatsoever, any liability of ST.

ST and the ST logo are trademarks or registered trademarks of ST in various countries.

Information in this document supersedes and replaces all information previously supplied.

The ST logo is a registered trademark of STMicroelectronics. All other names are the property of their respective owners.

© 2007 STMicroelectronics - All rights reserved

STMicroelectronics group of companies

Australia - Belgium - Brazil - Canada - China - Czech Republic - Finland - France - Germany - Hong Kong - India - Israel - Italy - Japan - Malaysia - Malta - Morocco - Singapore - Spain - Sweden - Switzerland - United Kingdom - United States of America

[www.st.com](http://www.st.com)