



STB18NF25, STD18NF25

N-channel 250 V, 0.14 Ω , 17 A low gate charge STripFET™ II
Power MOSFET in D²PAK and DPAK packages

Datasheet — production data

Features

Type	V _{DSS}	R _{DS(on) max}	I _D	P _{TOT}
STB18NF25	250 V	< 0.165 Ω	17 A	110 W
STD18NF25	250 V	< 0.165 Ω	17 A	110 W

- Low gate charge
- 100% avalanche tested
- Exceptional dv/dt capability

Application

- Switching applications
 - Automotive

Description

These Power MOSFETs have been developed using STMicroelectronics' unique STripFET process, which is specifically designed to minimize input capacitance and gate charge. This renders the devices suitable for use as primary switch in advanced high-efficiency isolated DC-DC converters for telecom and computer applications, and applications with low gate charge driving requirements.

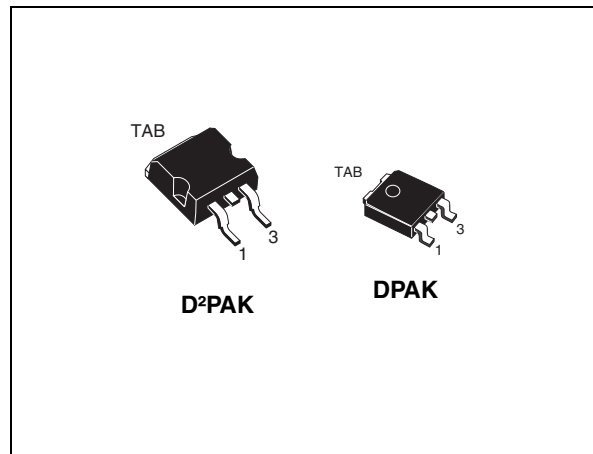

Figure 1. Internal schematic diagram

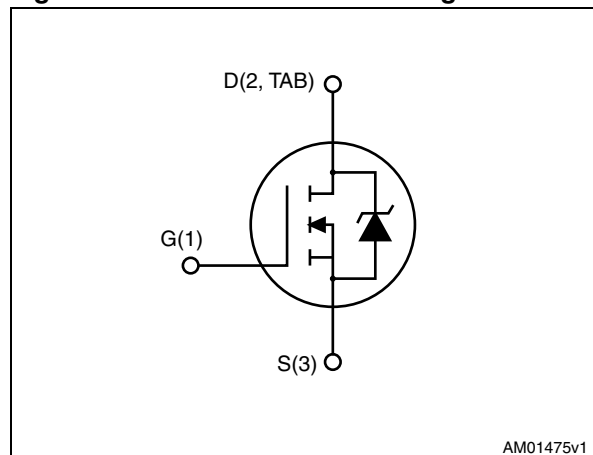

Table 1. Device summary

Order codes	Marking	Package	Packaging
STB18NF25	18NF25	D ² PAK	Tape and reel
STD18NF25	18NF25	DPAK	Tape and reel

Contents

1	Electrical ratings	3
2	Electrical characteristics	4
2.1	Electrical characteristics (curves)	6
3	Test circuits	9
4	Package mechanical data	10
5	Packaging mechanical data	14
6	Revision history	17

1 Electrical ratings

Table 2. Absolute maximum ratings

Symbol	Parameter	Value	Unit
V_{DS}	Drain-source voltage	250	V
V_{GS}	Gate-source voltage	± 20	V
I_D	Drain current (continuous) at $T_C = 25\text{ }^\circ\text{C}$	17	A
I_D	Drain current (continuous) at $T_C = 100\text{ }^\circ\text{C}$	12	A
$I_{DM}^{(1)}$	Drain current (pulsed)	68	A
P_{TOT}	Total dissipation at $T_C = 25\text{ }^\circ\text{C}$	110	W
$dv/dt^{(2)}$	Peak diode recovery voltage slope	10	V/ns
T_J T_{stg}	Operating junction temperature Storage temperature	-55 to 175	$^\circ\text{C}$

1. Pulse width limited by safe operating area.
2. $I_{SD} \leq 17\text{ A}$, $di/dt \leq 200\text{ A}/\mu\text{s}$, $V_{DD} \leq 80\%V_{(BR)DSS}$

Table 3. Thermal data

Symbol	Parameter	Value		Unit
		D ² PAK	DPAK	
$R_{thj-case}$	Thermal resistance junction-case max	1.36		$^\circ\text{C}/\text{W}$
$R_{thj-pcb}^{(1)}$	Thermal resistance junction-pcb max	30	50	$^\circ\text{C}/\text{W}$

1. When mounted on 1inch² FR-4, 2 Oz copper board.

Table 4. Avalanche data

Symbol	Parameter	Value	Unit
I_{AR}	Avalanche current, repetitive or not repetitive (pulse width limited by T_{jmax})	17	A
E_{AS}	Single pulse avalanche energy (starting $T_j = 25\text{ }^\circ\text{C}$, $I_D = I_{AR}$, $V_{DD} = 50\text{ V}$)	170	mJ

2 Electrical characteristics

($T_{CASE}=25\text{ °C}$ unless otherwise specified)

Table 5. On/off states

Symbol	Parameter	Test conditions	Min.	Typ.	Max.	Unit
$V_{(BR)DSS}$	Drain-source breakdown voltage	$V_{GS}=0, I_D=1\text{ mA}$	250			V
I_{DSS}	Zero gate voltage drain current	$V_{GS}=0, V_{DS}=250\text{ V},$			1	μA
		$V_{GS}=0$ $V_{DS}=250\text{ V}, T_C=125\text{ °C}$			10	μA
I_{GSS}	Gate body leakage current	$V_{DS}=0, V_{GS}=\pm 20\text{ V}$			± 100	nA
$V_{GS(th)}$	Gate threshold voltage	$V_{DS}=V_{GS}, I_D=250\text{ }\mu\text{A}$	2	3	4	V
$R_{DS(on)}$	Static drain-source on-resistance	$V_{GS}=10\text{ V}, I_D=8.5\text{ A}$		0.14	0.165	Ω

Table 6. Dynamic

Symbol	Parameter	Test conditions	Min.	Typ.	Max.	Unit
$g_{fs}^{(1)}$	Forward transconductance	$V_{DS}=15\text{ V}, I_D=8.5\text{ A}$	-	14	-	S
C_{iss} C_{oss} C_{rss}	Input capacitance Output capacitance Reverse transfer capacitance	$V_{DS}=25\text{ V}, f=1\text{ MHz}, V_{GS}=0$	-	1000 178 28	-	pF pF pF
$C_{o(tr)}$	Equivalent capacitance time related	$V_{DS}=0\text{ to }200\text{ V}, V_{GS}=0$	-	106	-	pF
$C_{o(er)}$	Equivalent capacitance energy related		-	79	-	pF
Q_g Q_{gs} Q_{gd}	Total gate charge Gate-source charge Gate-drain charge	$V_{DD}=200\text{ V}, I_D=17\text{ A}$ $V_{GS}=10\text{ V}$ (see Figure 17)	-	29.5 4.8 15.6	-	nC nC nC
R_G	Gate input resistance	f=1 MHz gate DC bias=0 test signal level=20 mV open drain	-	2	-	Ω

1. Pulsed: pulse duration=300 μs , duty cycle 1.5%

Table 7. Switching times

Symbol	Parameter	Test conditions	Min.	Typ.	Max.	Unit
$t_{d(on)}$ t_r	Turn-on delay time Rise time	$V_{DD}=125\text{ V}$, $I_D=8.5\text{ A}$, $R_G=4.7\ \Omega$, $V_{GS}=10\text{ V}$ (see Figure 16)	-	8.8 17.2	-	ns ns
$t_{d(off)}$ t_f	Turn-off delay time Fall time	$V_{DD}=125\text{ V}$, $I_D=8.5\text{ A}$, $R_G=4.7\ \Omega$, $V_{GS}=10\text{ V}$ (see Figure 16)	-	21 8.8	-	ns ns

Table 8. Source drain diode

Symbol	Parameter	Test conditions	Min.	Typ.	Max.	Unit
I_{SD} $I_{SDM}^{(1)}$	Source-drain current Source-drain current (pulsed)		-		17 68	A A
$V_{SD}^{(2)}$	Forward on voltage	$I_{SD}=17\text{ A}$, $V_{GS}=0$	-		1.5	V
t_{rr} Q_{rr} I_{RRM}	Reverse recovery time Reverse recovery charge Reverse recovery current	$I_{SD} = 17\text{ A}$, $di/dt = 100\text{ A}/\mu\text{s}$, $V_{DD} = 50\text{ V}$ (see Figure 18)	-	157 0.91 11.6		ns μC A
t_{rr} Q_{rr} I_{RRM}	Reverse recovery time Reverse recovery charge Reverse recovery current	$I_{SD} = 17\text{ A}$, $di/dt = 100\text{ A}/\mu\text{s}$, $V_{DD} = 50\text{ V}$, $T_j=150\text{ }^\circ\text{C}$ (see Figure 18)	-	196 1.34 13.7		ns μC A

1. Pulse width limited by safe operating area
2. Pulsed: pulse duration=300 μs , duty cycle 1.5%

2.1 Electrical characteristics (curves)

Figure 2. Safe operating area for D²PAK

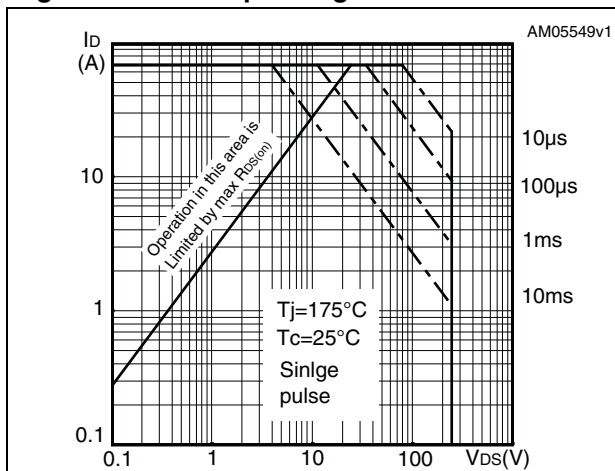

Figure 3. Thermal impedance for D²PAK

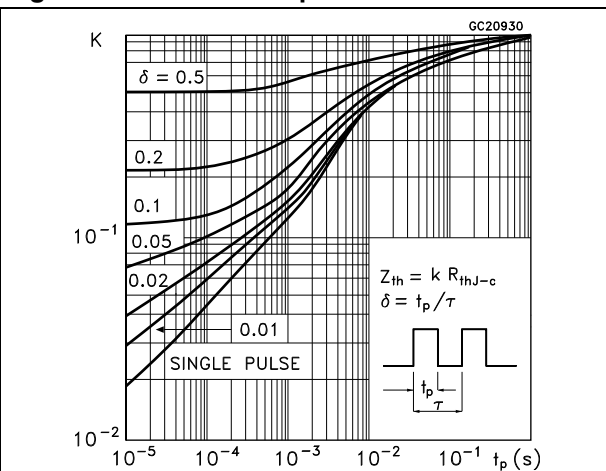

Figure 4. Safe operating area for DPAK

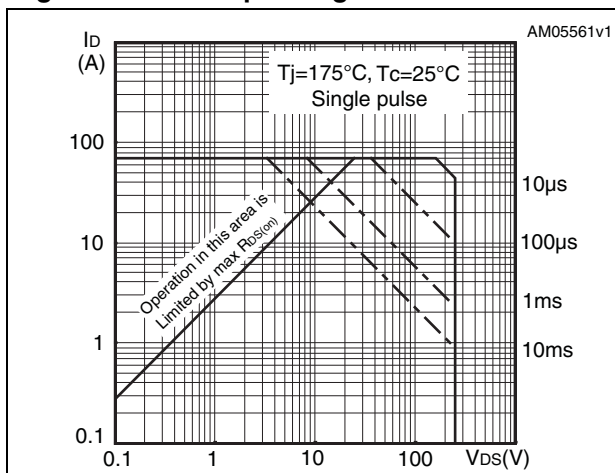

Figure 5. Thermal impedance for DPAK

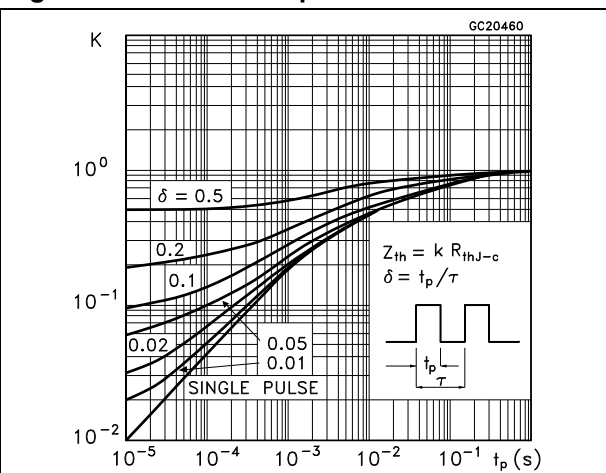

Figure 6. Output characteristics

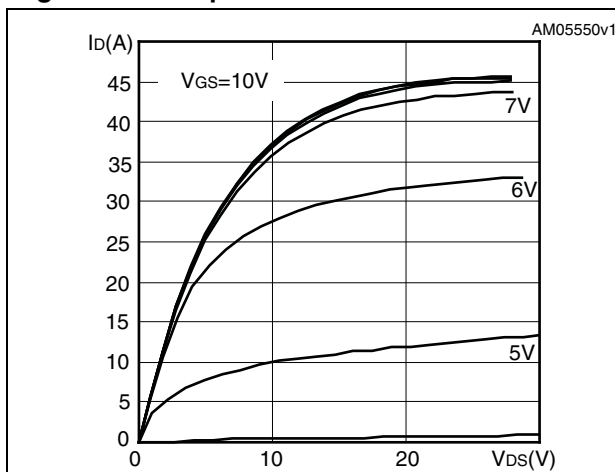

Figure 7. Transfer characteristics

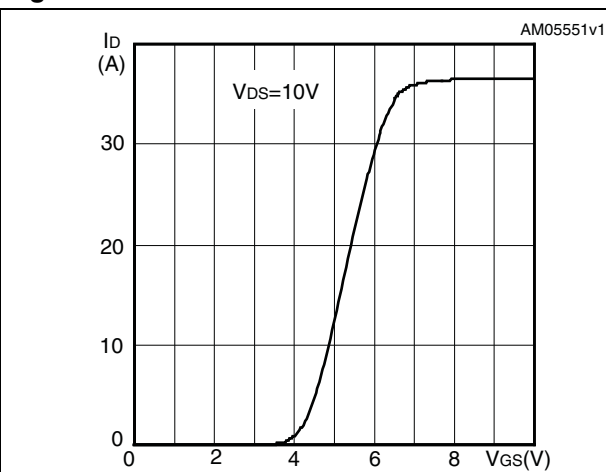

Figure 8. Gate charge vs gate-source voltage Figure 9. Static drain-source on-resistance

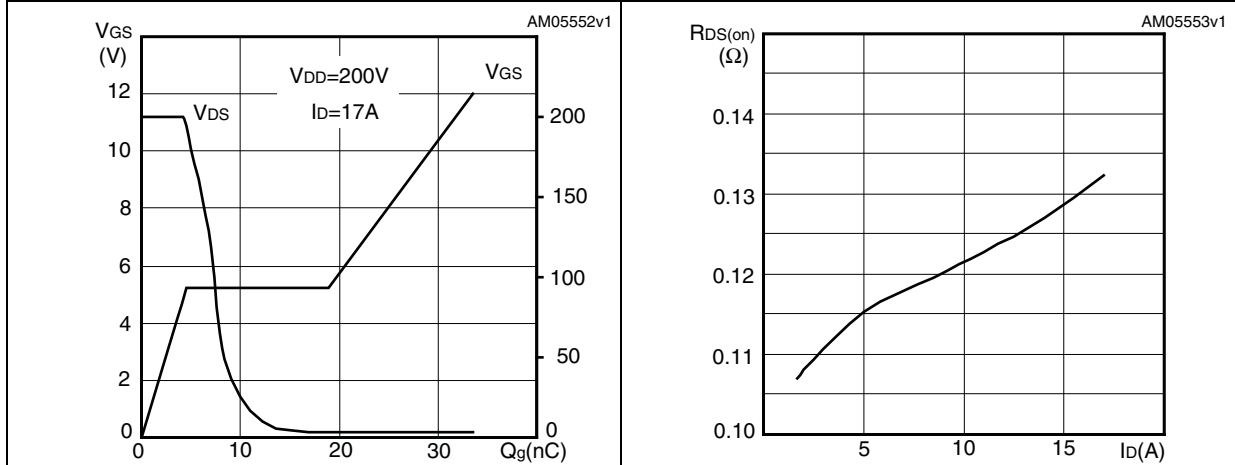

Figure 10. Output capacitance stored energy Figure 11. Capacitance variations

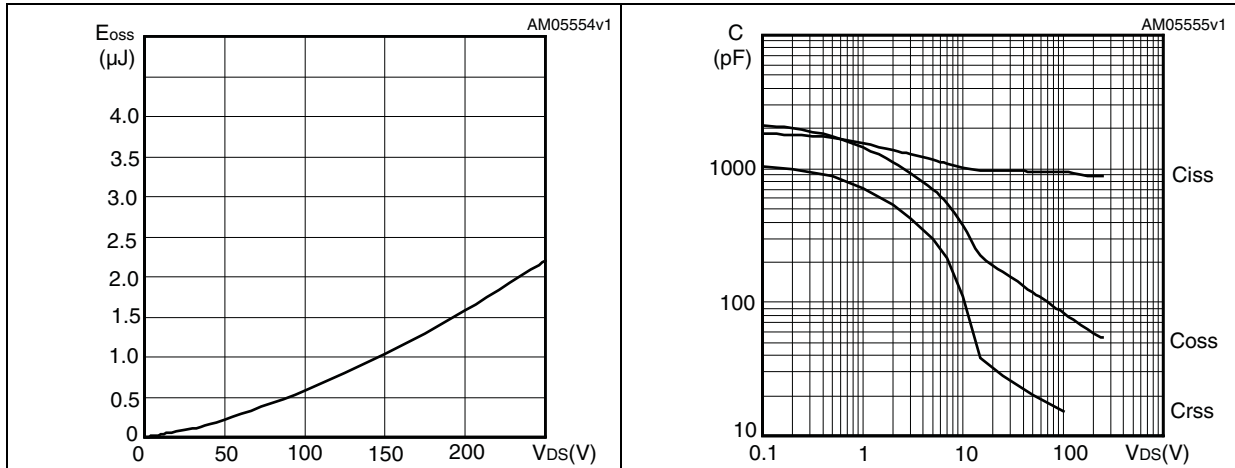

Figure 12. Normalized gate threshold voltage vs temperature Figure 13. Normalized on resistance vs temperature

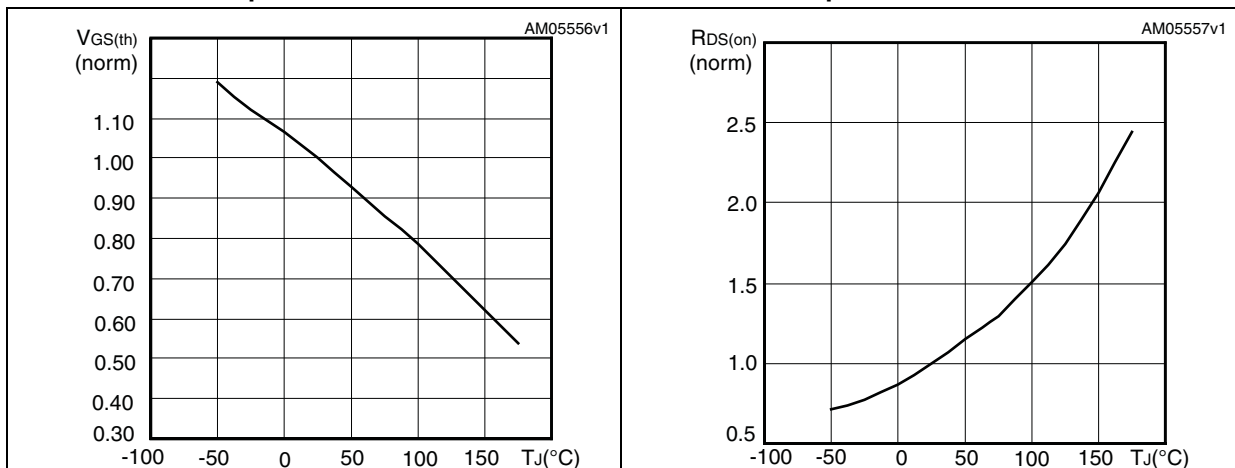

Figure 14. Source-drain diode forward characteristics

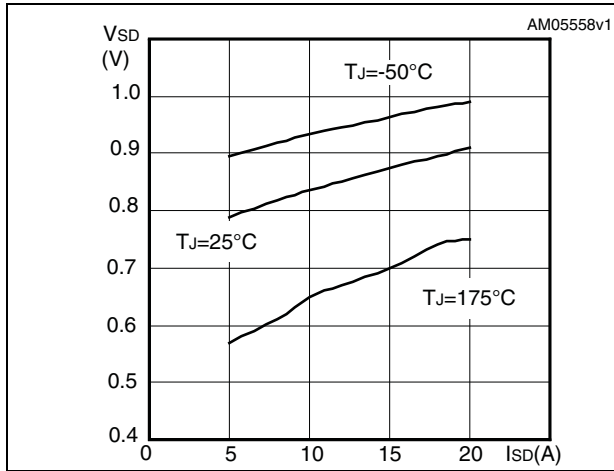
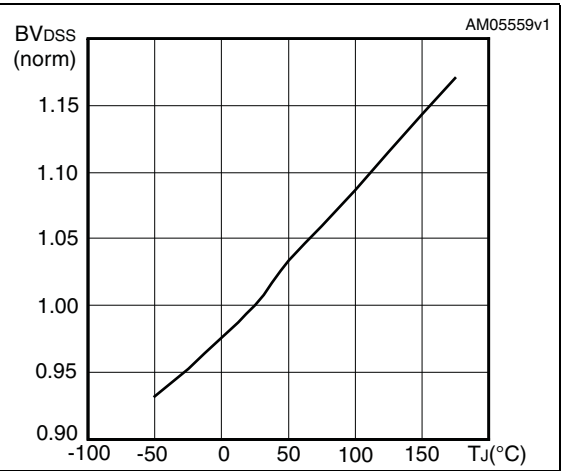

Figure 15. Normalized B_{VDS} vs temperature



3 Test circuits

Figure 16. Switching times test circuit for resistive load



AM01468v1

Figure 17. Gate charge test circuit



AM01469v1

Figure 18. Test circuit for inductive load switching and diode recovery times



AM01470v1

Figure 19. Unclamped inductive load test circuit



AM01471v1

Figure 20. Unclamped inductive waveform



AM01472v1

Figure 21. Switching time waveform



AM01473v1

4 Package mechanical data

In order to meet environmental requirements, ST offers these devices in different grades of ECOPACK® packages, depending on their level of environmental compliance. ECOPACK® specifications, grade definitions and product status are available at: www.st.com. ECOPACK is an ST trademark.

Table 9. D²PAK (TO-263) mechanical data

Dim.	mm		
	Min.	Typ.	Max.
A	4.40		4.60
A1	0.03		0.23
b	0.70		0.93
b2	1.14		1.70
c	0.45		0.60
c2	1.23		1.36
D	8.95		9.35
D1	7.50		
E	10		10.40
E1	8.50		
e		2.54	
e1	4.88		5.28
H	15		15.85
J1	2.49		2.69
L	2.29		2.79
L1	1.27		1.40
L2	1.30		1.75
R		0.4	
V2	0°		8°

Figure 22. D²PAK (TO-263) drawing



Figure 23. D²PAK footprint^(a)



a. All dimensions are in millimeters

Table 10. DPAK (TO-252) mechanical data

Dim.	mm		
	Min.	Typ.	Max.
A	2.20		2.40
A1	0.90		1.10
A2	0.03		0.23
b	0.64		0.90
b4	5.20		5.40
c	0.45		0.60
c2	0.48		0.60
D	6.00		6.20
D1		5.10	
E	6.40		6.60
E1		4.70	
e		2.28	
e1	4.40		4.60
H	9.35		10.10
L	1		1.50
L1		2.80	
L2		0.80	
L4	0.60		1
R		0.20	
V2	0°		8°

Figure 24. DPAK (TO-252) drawing

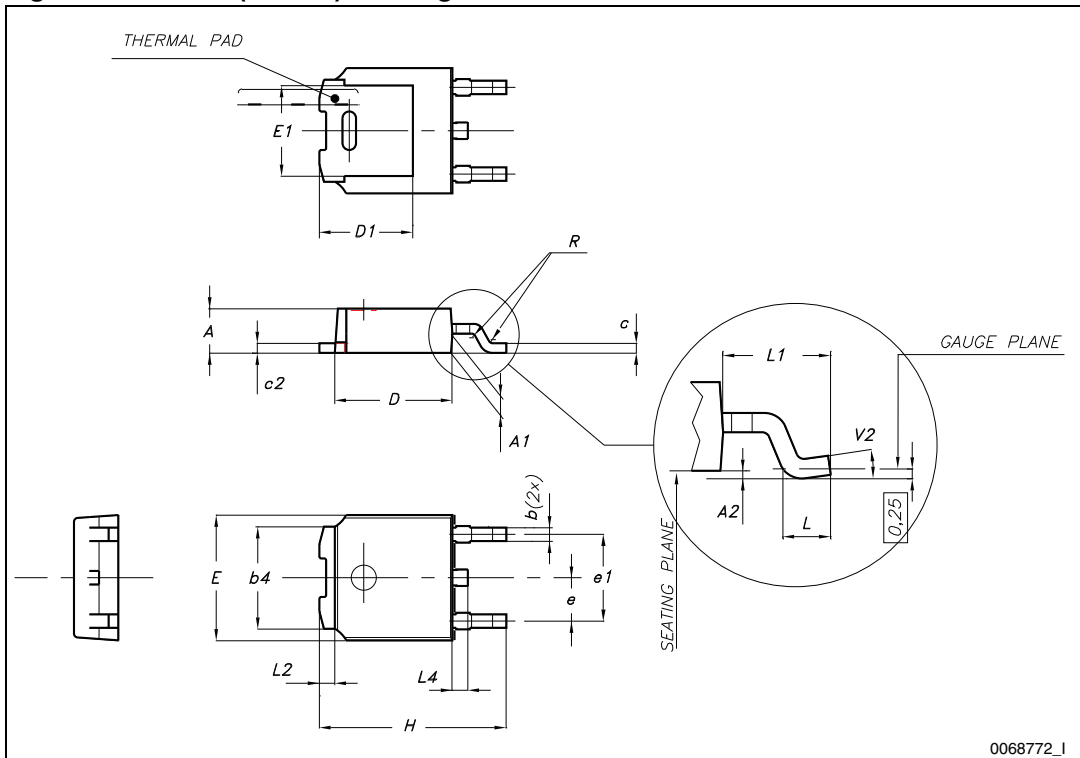

5 Packaging mechanical data

Table 11. D²PAK (TO-263) tape and reel mechanical data

Tape			Reel		
Dim.	mm		Dim.	mm	
	Min.	Max.		Min.	Max.
A0	10.5	10.7	A		330
B0	15.7	15.9	B	1.5	
D	1.5	1.6	C	12.8	13.2
D1	1.59	1.61	D	20.2	
E	1.65	1.85	G	24.4	26.4
F	11.4	11.6	N	100	
K0	4.8	5.0	T		30.4
P0	3.9	4.1			
P1	11.9	12.1	Base qty		1000
P2	1.9	2.1	Bulk qty		1000
R	50				
T	0.25	0.35			
W	23.7	24.3			

Table 12. DPAK (TO-252) tape and reel mechanical data

Tape			Reel		
Dim.	mm		Dim.	mm	
	Min.	Max.		Min.	Max.
A0	6.8	7	A		330
B0	10.4	10.6	B	1.5	
B1		12.1	C	12.8	13.2
D	1.5	1.6	D	20.2	
D1	1.5		G	16.4	18.4
E	1.65	1.85	N	50	
F	7.4	7.6	T		22.4
K0	2.55	2.75			
P0	3.9	4.1	Base qty.		2500
P1	7.9	8.1	Bulk qty.		2500

Table 12. DPAK (TO-252) tape and reel mechanical data (continued)

Tape			Reel		
Dim.	mm		Dim.	mm	
	Min.	Max.		Min.	Max.
P2	1.9	2.1			
R	40				
T	0.25	0.35			
W	15.7	16.3			

Figure 25. Tape

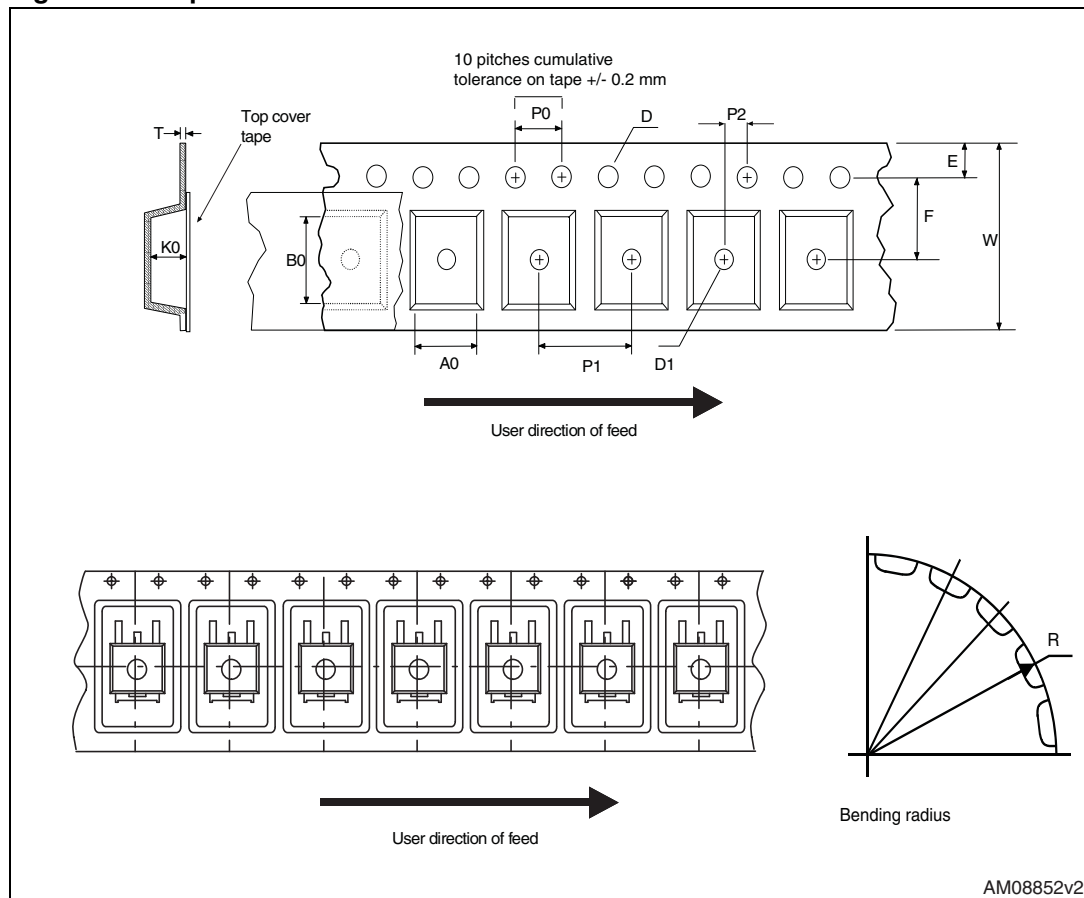
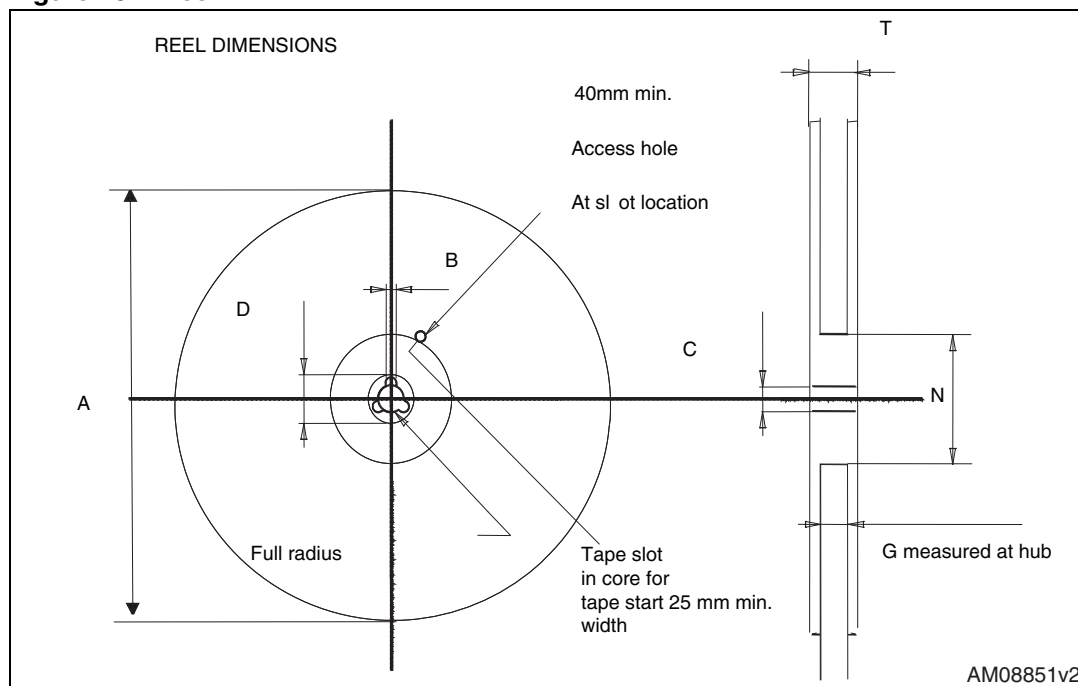

Figure 26. Reel



6 Revision history

Table 13. Document revision history

Date	Revision	Changes
16-Nov-2009	1	First release
19-Feb-2010	2	V_{DS} value in Table 8 has been corrected.
26-Apr-2012	3	Updated E_{AS} in Table 4: Avalanche data , Section 4: Package mechanical data and Section 5: Packaging mechanical data . Minor text changes.

Please Read Carefully:

Information in this document is provided solely in connection with ST products. STMicroelectronics NV and its subsidiaries ("ST") reserve the right to make changes, corrections, modifications or improvements, to this document, and the products and services described herein at any time, without notice.

All ST products are sold pursuant to ST's terms and conditions of sale.

Purchasers are solely responsible for the choice, selection and use of the ST products and services described herein, and ST assumes no liability whatsoever relating to the choice, selection or use of the ST products and services described herein.

No license, express or implied, by estoppel or otherwise, to any intellectual property rights is granted under this document. If any part of this document refers to any third party products or services it shall not be deemed a license grant by ST for the use of such third party products or services, or any intellectual property contained therein or considered as a warranty covering the use in any manner whatsoever of such third party products or services or any intellectual property contained therein.

UNLESS OTHERWISE SET FORTH IN ST'S TERMS AND CONDITIONS OF SALE ST DISCLAIMS ANY EXPRESS OR IMPLIED WARRANTY WITH RESPECT TO THE USE AND/OR SALE OF ST PRODUCTS INCLUDING WITHOUT LIMITATION IMPLIED WARRANTIES OF MERCHANTABILITY, FITNESS FOR A PARTICULAR PURPOSE (AND THEIR EQUIVALENTS UNDER THE LAWS OF ANY JURISDICTION), OR INFRINGEMENT OF ANY PATENT, COPYRIGHT OR OTHER INTELLECTUAL PROPERTY RIGHT.

UNLESS EXPRESSLY APPROVED IN WRITING BY TWO AUTHORIZED ST REPRESENTATIVES, ST PRODUCTS ARE NOT RECOMMENDED, AUTHORIZED OR WARRANTED FOR USE IN MILITARY, AIR CRAFT, SPACE, LIFE SAVING, OR LIFE SUSTAINING APPLICATIONS, NOR IN PRODUCTS OR SYSTEMS WHERE FAILURE OR MALFUNCTION MAY RESULT IN PERSONAL INJURY, DEATH, OR SEVERE PROPERTY OR ENVIRONMENTAL DAMAGE. ST PRODUCTS WHICH ARE NOT SPECIFIED AS "AUTOMOTIVE GRADE" MAY ONLY BE USED IN AUTOMOTIVE APPLICATIONS AT USER'S OWN RISK.

Resale of ST products with provisions different from the statements and/or technical features set forth in this document shall immediately void any warranty granted by ST for the ST product or service described herein and shall not create or extend in any manner whatsoever, any liability of ST.

ST and the ST logo are trademarks or registered trademarks of ST in various countries.

Information in this document supersedes and replaces all information previously supplied.

The ST logo is a registered trademark of STMicroelectronics. All other names are the property of their respective owners.

© 2012 STMicroelectronics - All rights reserved

STMicroelectronics group of companies

Australia - Belgium - Brazil - Canada - China - Czech Republic - Finland - France - Germany - Hong Kong - India - Israel - Italy - Japan - Malaysia - Malta - Morocco - Philippines - Singapore - Spain - Sweden - Switzerland - United Kingdom - United States of America

www.st.com