

IRFHM830PbF

HEXFET® Power MOSFET

V_{DS}	30	V
$R_{DS(on) \max}$ (@ $V_{GS} = 10V$)	3.8	mΩ
Q_g (typical)	15	nC
R_G (typical)	2.5	Ω
I_D (@ $T_{c(Bottom)} = 25^\circ C$)	40^⑥	A

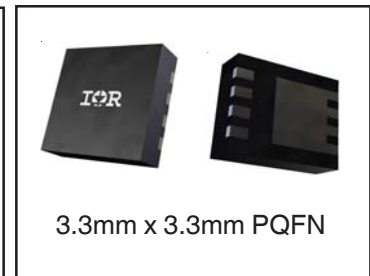
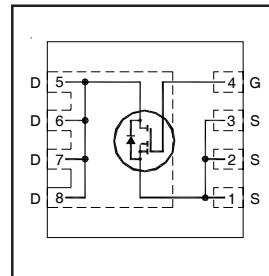

Applications

- Battery Operated DC Motor Inverter MOSFET

Features and Benefits

Features

Low $R_{DS(on)}$ (<3.8m Ω)
Low Thermal Resistance to PCB (<3.4°C/W)
100% Rg tested
Low Profile (<1.0mm)
Industry-Standard Pinout
Compatible with Existing Surface Mount Techniques
RoHS Compliant Containing no Lead, no Bromide and no Halogen
MSL1, Industrial Qualification

results in
⇒

Benefits

Lower Conduction Losses
Enable better thermal dissipation
Increased Reliability
Increased Power Density
Multi-Vendor Compatibility
Easier Manufacturing
Environmentally Friendlier
Increased Reliability

Orderable part number	Package Type	Standard Pack		Note
		Form	Quantity	
IRFHM830TRPBF	PQFN 3.3mm x 3.3mm	Tape and Reel	4000	
IRFHM830TR2PBF	PQFN 3.3mm x 3.3mm	Tape and Reel	400	

Absolute Maximum Ratings

	Parameter	Max.	Units
V_{DS}	Drain-to-Source Voltage	30	V
V_{GS}	Gate-to-Source Voltage	±20	
$I_D @ T_A = 25^\circ C$	Continuous Drain Current, $V_{GS} @ 10V$	21	A
$I_D @ T_A = 70^\circ C$	Continuous Drain Current, $V_{GS} @ 10V$	17	
$I_D @ T_{c(Bottom)} = 25^\circ C$	Continuous Drain Current, $V_{GS} @ 10V$	40 ^⑥	
$I_D @ T_{c(Bottom)} = 100^\circ C$	Continuous Drain Current, $V_{GS} @ 10V$	40 ^⑥	
I_{DM}	Pulsed Drain Current ^①	160	
$P_D @ T_A = 25^\circ C$	Power Dissipation ^⑤	2.7	W
$P_D @ T_{c(Bottom)} = 25^\circ C$	Power Dissipation ^⑤	37	
	Linear Derating Factor ^⑤	0.022	W/°C
T_J T_{STG}	Operating Junction and Storage Temperature Range	-55 to + 150	°C

Notes ^① through ^⑤ are on page 8

Static @ $T_J = 25^\circ\text{C}$ (unless otherwise specified)

	Parameter	Min.	Typ.	Max.	Units	Conditions
BV_{DSS}	Drain-to-Source Breakdown Voltage	30	—	—	V	$V_{GS} = 0V, I_D = 250\mu A$
$\Delta BV_{DSS}/\Delta T_J$	Breakdown Voltage Temp. Coefficient	—	0.02	—	V/ $^\circ\text{C}$	Reference to $25^\circ\text{C}, I_D = 1mA$
$R_{DS(on)}$	Static Drain-to-Source On-Resistance	—	3.0	3.8	m Ω	$V_{GS} = 10V, I_D = 20A$ ③
		—	4.8	6.0		$V_{GS} = 4.5V, I_D = 20A$ ③
$V_{GS(th)}$	Gate Threshold Voltage	1.35	1.8	2.35	V	$V_{DS} = V_{GS}, I_D = 50\mu A$
$\Delta V_{GS(th)}$	Gate Threshold Voltage Coefficient	—	-6.3	—	mV/ $^\circ\text{C}$	
I_{DSS}	Drain-to-Source Leakage Current	—	—	1.0	μA	$V_{DS} = 24V, V_{GS} = 0V$
		—	—	150		$V_{DS} = 24V, V_{GS} = 0V, T_J = 125^\circ\text{C}$
I_{GSS}	Gate-to-Source Forward Leakage	—	—	100	nA	$V_{GS} = 20V$
	Gate-to-Source Reverse Leakage	—	—	-100		$V_{GS} = -20V$
g_{fs}	Forward Transconductance	52	—	—	S	$V_{DS} = 15V, I_D = 20A$
Q_g	Total Gate Charge	—	31	—	nC	$V_{GS} = 10V, V_{DS} = 15V, I_D = 20A$
Q_g	Total Gate Charge	—	15	23	nC	$V_{DS} = 15V$ $V_{GS} = 4.5V$ $I_D = 20A$ See Fig.17 & 18
Q_{gs1}	Pre-Vth Gate-to-Source Charge	—	3.8	—		
Q_{gs2}	Post-Vth Gate-to-Source Charge	—	2.0	—		
Q_{gd}	Gate-to-Drain Charge	—	5.0	—		
Q_{godr}	Gate Charge Overdrive	—	4.2	—		
Q_{sw}	Switch Charge ($Q_{gs2} + Q_{gd}$)	—	7.0	—		
Q_{oss}	Output Charge	—	9.7	—	nC	$V_{DS} = 16V, V_{GS} = 0V$
R_G	Gate Resistance	—	2.5	—	Ω	
$t_{d(on)}$	Turn-On Delay Time	—	12	—	ns	$V_{DD} = 15V, V_{GS} = 4.5V$ $I_D = 20A$ $R_G = 1.8\Omega$ See Fig.15
t_r	Rise Time	—	25	—		
$t_{d(off)}$	Turn-Off Delay Time	—	13	—		
t_f	Fall Time	—	9.2	—		
C_{iss}	Input Capacitance	—	2155	—	pF	$V_{GS} = 0V$ $V_{DS} = 25V$ $f = 1.0MHz$
C_{oss}	Output Capacitance	—	350	—		
C_{riss}	Reverse Transfer Capacitance	—	160	—		

Avalanche Characteristics

	Parameter	Typ.	Max.	Units
E_{AS}	Single Pulse Avalanche Energy ②	—	82	mJ
I_{AR}	Avalanche Current ①	—	20	A

Diode Characteristics

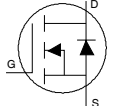
	Parameter	Min.	Typ.	Max.	Units	Conditions
I_S	Continuous Source Current (Body Diode) ⑥	—	—	40	A	MOSFET symbol showing the integral reverse p-n junction diode. 
I_{SM}	Pulsed Source Current (Body Diode) ①	—	—	160		
V_{SD}	Diode Forward Voltage	—	—	1.0	V	$T_J = 25^\circ\text{C}, I_S = 20A, V_{GS} = 0V$ ③
t_{rr}	Reverse Recovery Time	—	17	26	ns	$T_J = 25^\circ\text{C}, I_F = 20A, V_{DD} = 15V$
Q_{rr}	Reverse Recovery Charge	—	23	35	nC	$di/dt = 300A/\mu s$ ③
t_{on}	Forward Turn-On Time	Time is dominated by parasitic Inductance				

Thermal Resistance

	Parameter	Typ.	Max.	Units
$R_{\theta JC}$ (Bottom)	Junction-to-Case ④	—	3.4	$^\circ\text{C/W}$
$R_{\theta JC}$ (Top)	Junction-to-Case ④	—	37	
$R_{\theta JA}$	Junction-to-Ambient ⑤	—	46	
$R_{\theta JA} (<10s)$	Junction-to-Ambient ⑤	—	31	

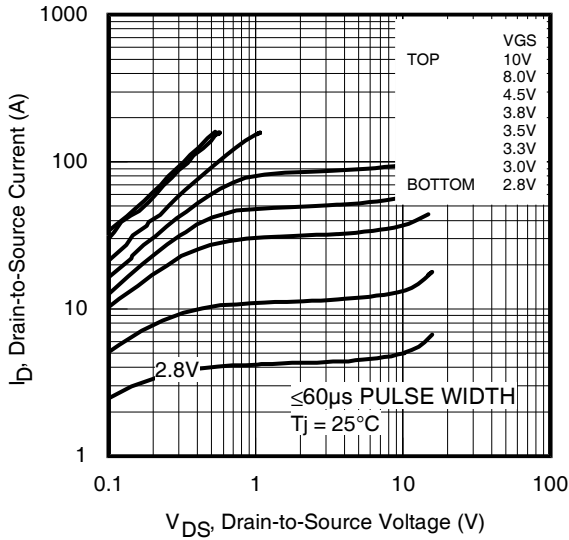

Fig 1. Typical Output Characteristics

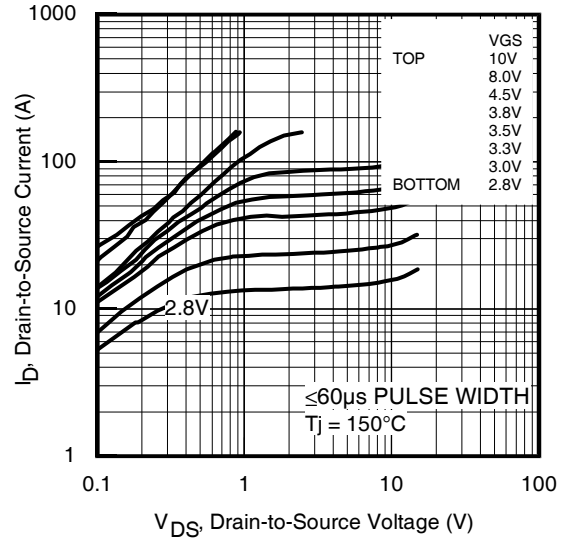

Fig 2. Typical Output Characteristics

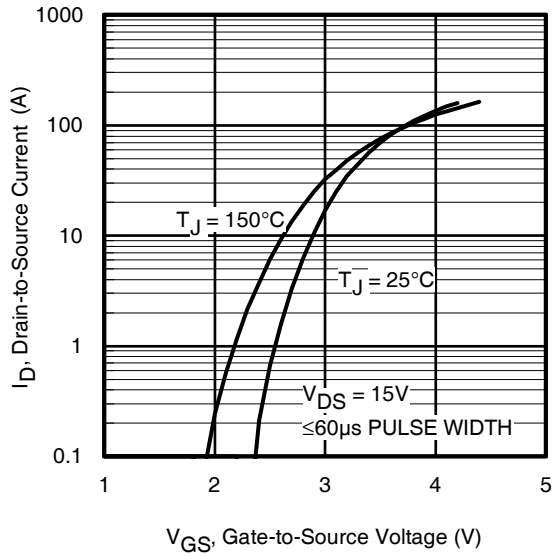

Fig 3. Typical Transfer Characteristics

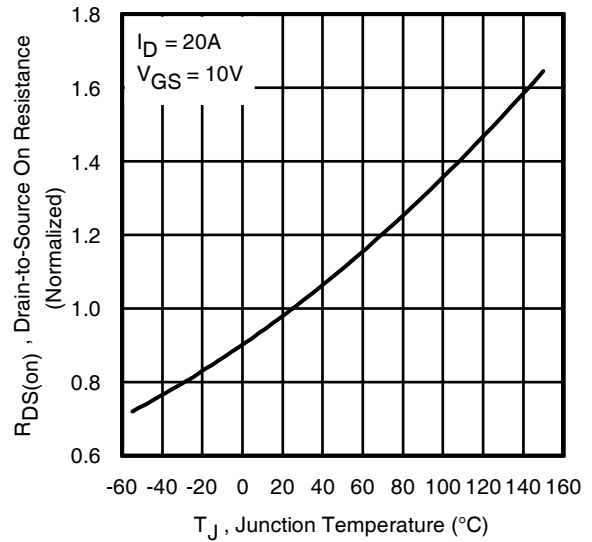

Fig 4. Normalized On-Resistance vs. Temperature

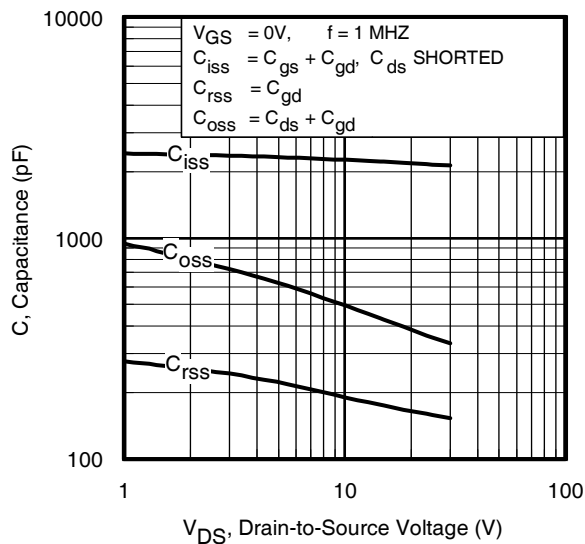

Fig 5. Typical Capacitance vs. Drain-to-Source Voltage
www.irf.com

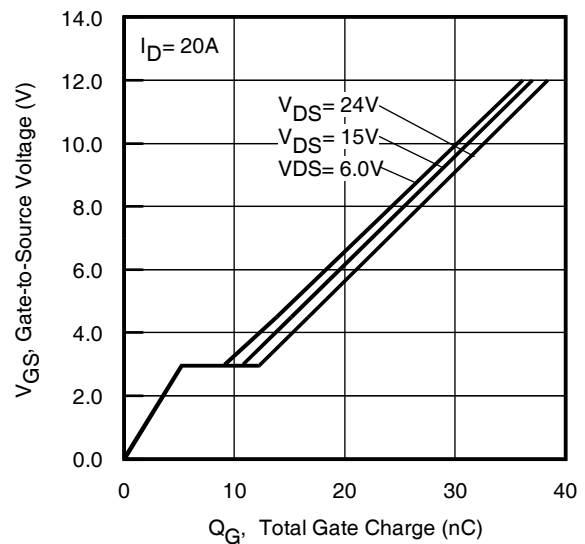

Fig 6. Typical Gate Charge vs. Gate-to-Source Voltage

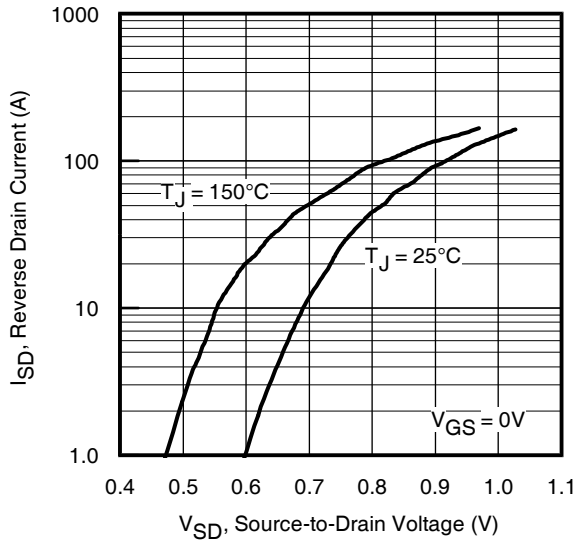

Fig 7. Typical Source-Drain Diode Forward Voltage

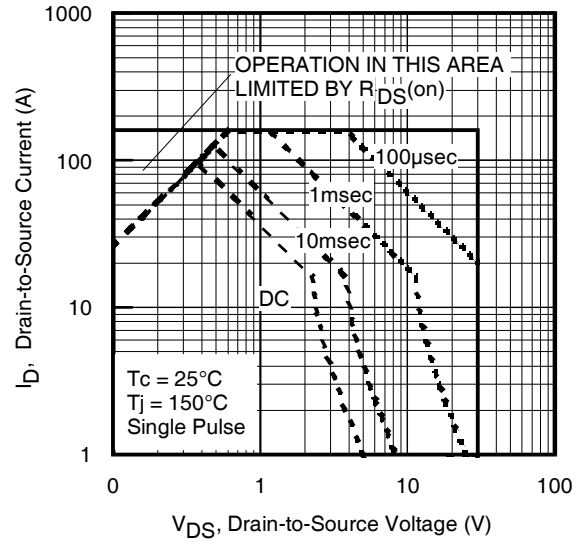

Fig 8. Maximum Safe Operating Area

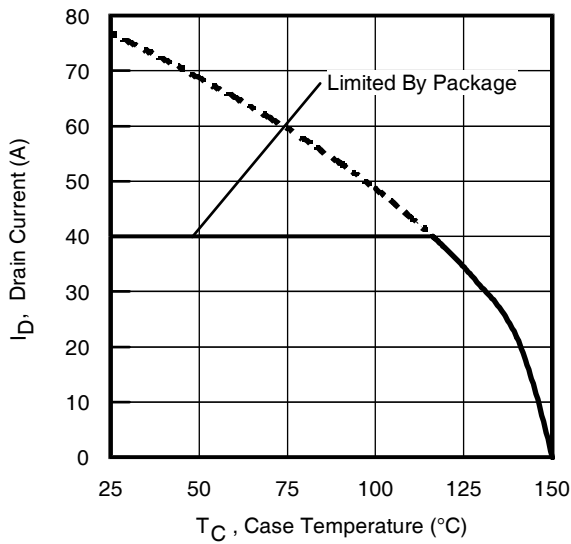

Fig 9. Maximum Drain Current vs. Case (Bottom) Temperature

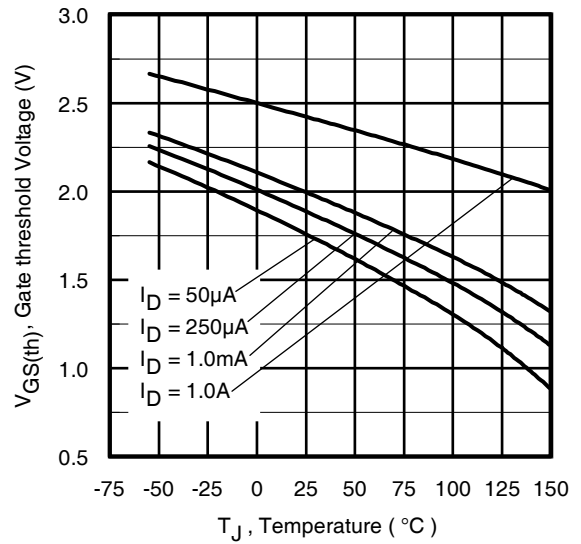

Fig 10. Threshold Voltage vs. Temperature

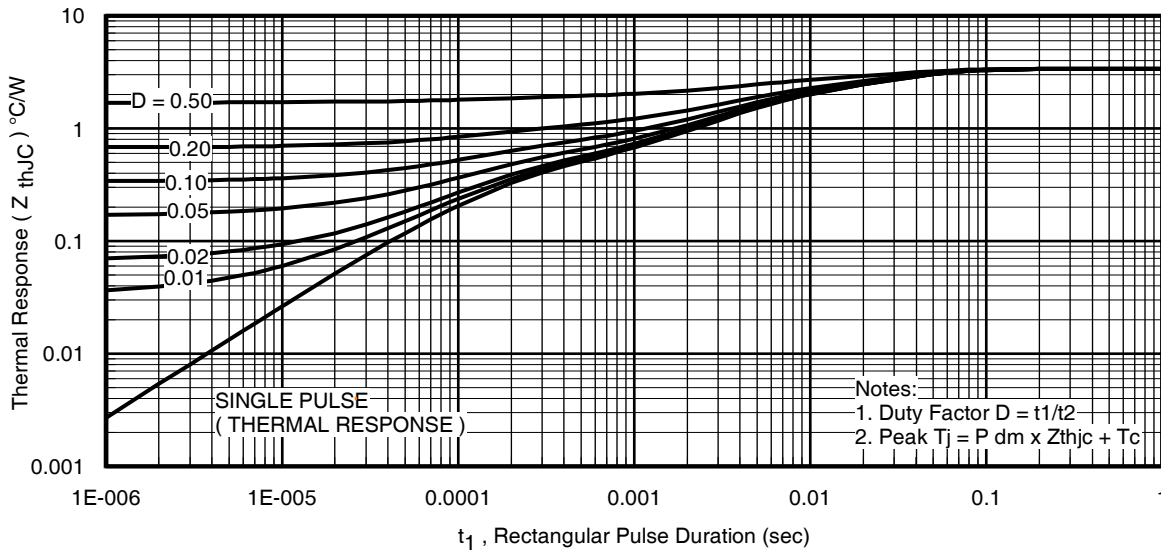

Fig 11. Maximum Effective Transient Thermal Impedance, Junction-to-Case (Bottom)

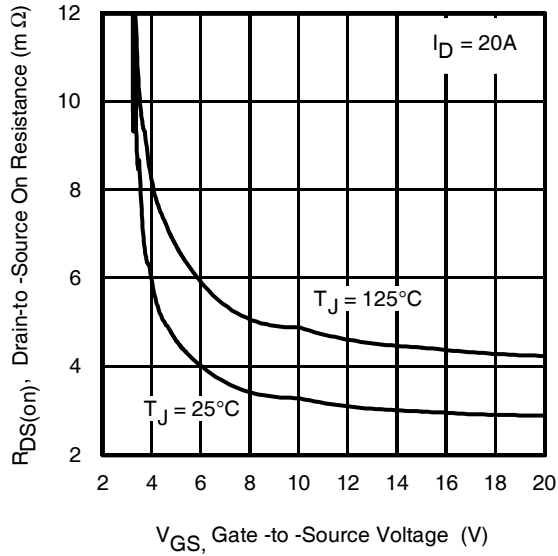

Fig 12. On-Resistance vs. Gate Voltage

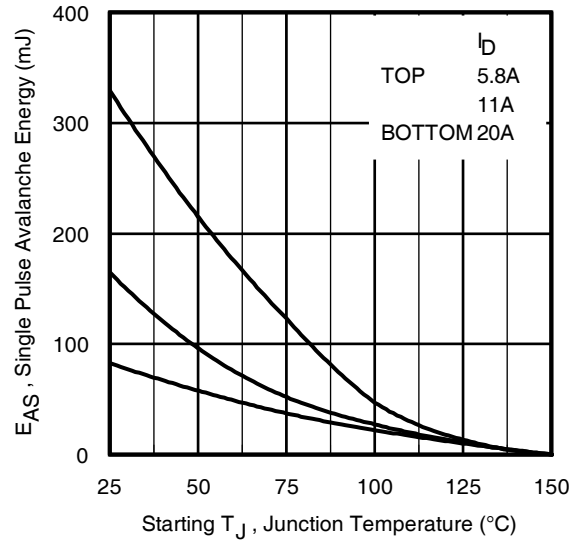

Fig 13. Maximum Avalanche Energy vs. Drain Current

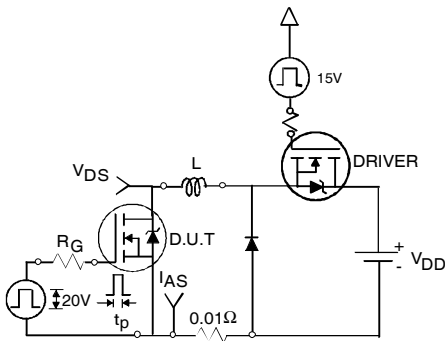

Fig 14a. Unclamped Inductive Test Circuit

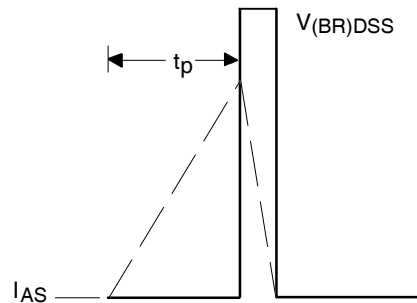

Fig 14b. Unclamped Inductive Waveforms

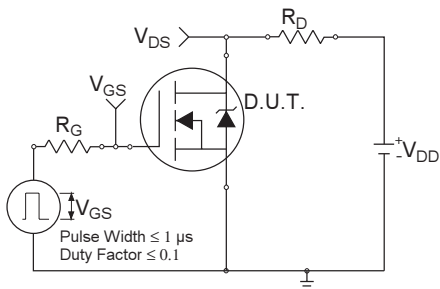

Fig 15a. Switching Time Test Circuit

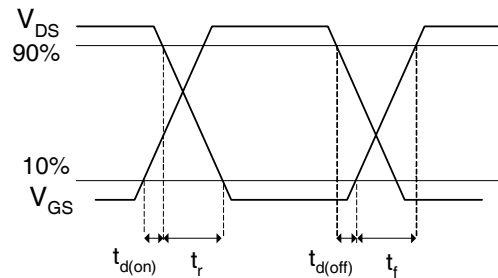

Fig 15b. Switching Time Waveforms

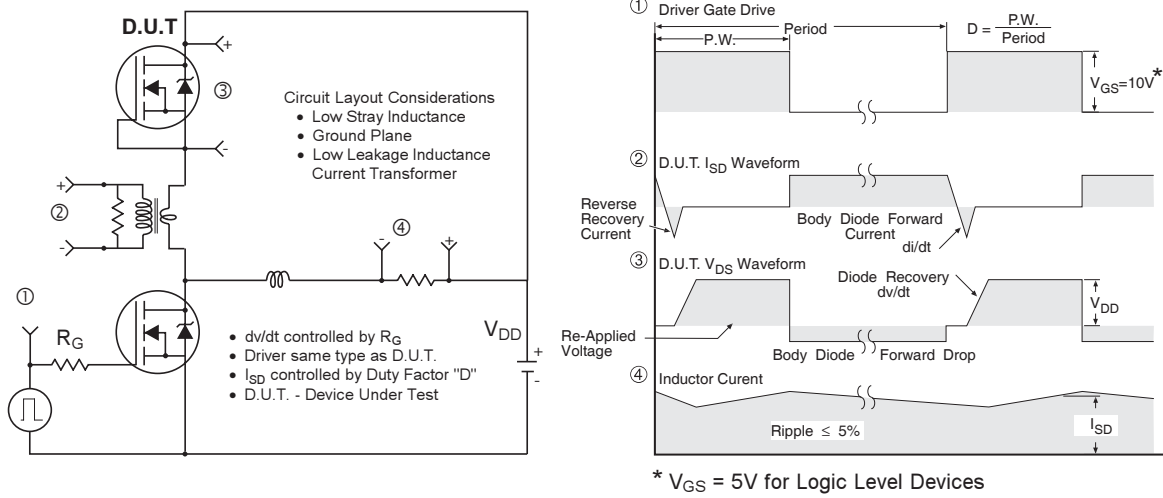

Fig 16. Peak Diode Recovery dv/dt Test Circuit for N-Channel HEXFET[®] Power MOSFETs

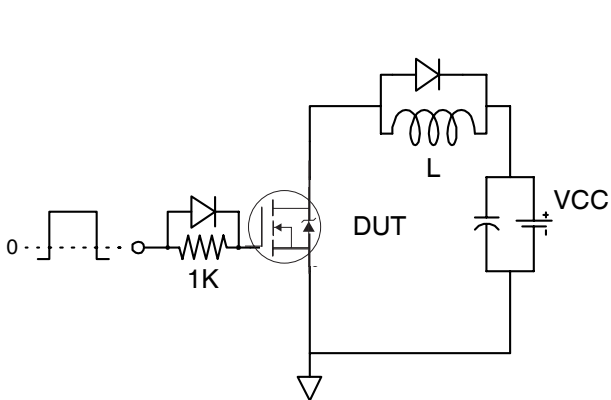

Fig 17. Gate Charge Test Circuit

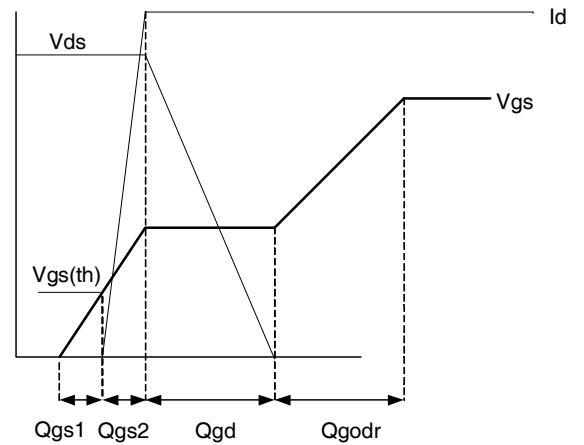
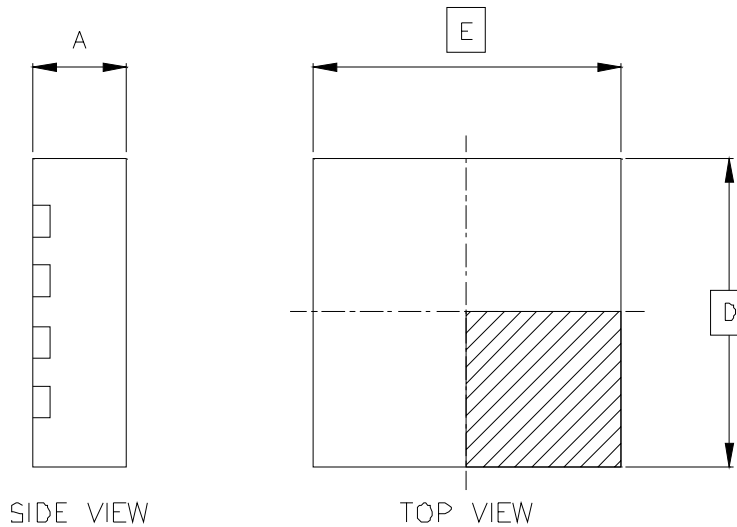
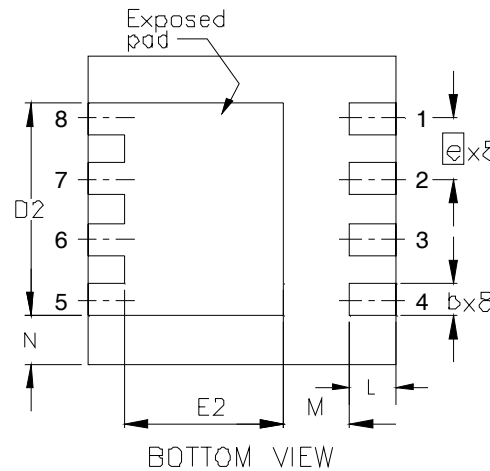

Fig 18. Gate Charge Waveform

PQFN 3.3x3.3 Outline Package Details



OUTLINE PQFN 3.3x3.3A			
DIM SYMBOL	DIM	MIN	MAX
A		0.80	1.00
b		0.25	0.40
D		3.30	BSC
D2		2.14	2.39
e		0.65	BSC
E		3.30	BSC
E2		1.66	1.91
L		0.30	0.55
M		0.59	—
N		0.505	REF



For footprint and stencil design recommendations, please refer to application note AN-1154 at <http://www.irf.com/technical-info/appnotes/an-1154.pdf>

PQFN 3.3x3.3 Outline Part Marking

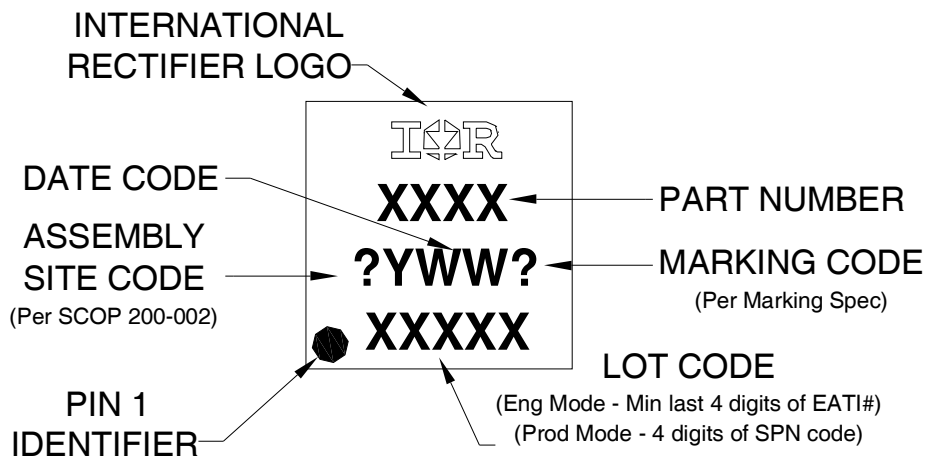

Note: For the most current drawing please refer to IR website at: <http://www.irf.com/package/>
www.irf.com

PQFN 3.3x3.3 Outline Tape and Reel

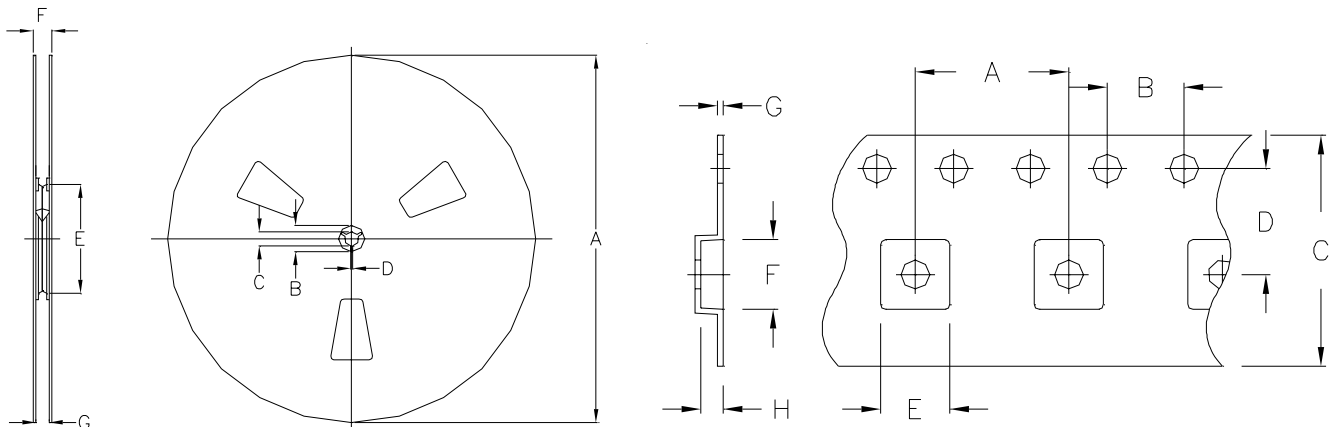

NOTE: Controlling dimensions in mm
Std reel quantity is 4000 parts.

REEL DIMENSIONS				
STANDARD OPTION (QTY 4000)				
	METRIC		IMPERIAL	
CODE	MIN	MAX	MIN	MAX
A	326.0	330.25	12.835	13.002
B	20.2	20.45	0.795	0.805
C	12.8	13.50	0.504	0.531
D	1.5	2.5	0.059	0.098
E	102.0 REF		4.016 REF	
F	17.8	18.3	0.701	0.720
G	12.4	12.9	0.488	0.508

DIMENSIONS				
	METRIC		IMPERIAL	
CODE	MIN	MAX	MIN	MAX
A	7.90	8.10	0.311	0.319
B	3.90	4.10	0.154	0.161
C	11.70	12.30	0.461	0.484
D	5.45	5.55	0.215	0.219
E	3.50	3.70	0.138	0.146
F	3.50	3.70	0.138	0.146
G	0.25	0.35	0.010	0.014
H	1.10	1.30	0.043	0.051

Qualification Information[†]

Qualification level	Industrial ^{††} (per JEDEC JESD47F ^{†††} guidelines)	
Moisture Sensitivity Level	PQFN 3.3mm x 3.3mm	MSL1 (per JEDEC J-STD-020D ^{†††})
RoHS Compliant	Yes	

[†] Qualification standards can be found at International Rectifier's web site

<http://www.irf.com/product-info/reliability>

^{††} Higher qualification ratings may be available should the user have such requirements.

Please contact your International Rectifier sales representative for further information:

<http://www.irf.com/whoto-call/salesrep/>

^{†††} Applicable version of JEDEC standard at the time of product release.

Notes:

- ① Repetitive rating; pulse width limited by max. junction temperature.
- ② Starting $T_J = 25^\circ\text{C}$, $L = 0.41\text{mH}$, $R_G = 25\Omega$, $I_{AS} = 20\text{A}$.
- ③ Pulse width $\leq 400\mu\text{s}$; duty cycle $\leq 2\%$.
- ④ R_θ is measured at T_J of approximately 90°C .
- ⑤ When mounted on 1 inch square 2 oz copper pad on 1.5x1.5 in. board of FR-4 material.
- ⑥ Calculated continuous current based on maximum allowable junction temperature. Package is limited to 40A by production test capability.

Data and specifications subject to change without notice.

International
IR Rectifier

IR WORLD HEADQUARTERS: 233 Kansas St., El Segundo, California 90245, USA Tel: (310) 252-7105

TAC Fax: (310) 252-7903

Visit us at www.irf.com for sales contact information.09/2010