

# N-Channel NexFET™ Power MOSFET

 Check for Samples: [CSD16404Q5A](#)

## FEATURES

- Ultralow  $Q_g$  and  $Q_{gd}$
- Low Thermal Resistance
- Avalanche Rated
- Pb Free Terminal Plating
- RoHS Compliant
- Halogen Free
- SON 5-mm x 6-mm Plastic Package

## APPLICATIONS

- Point-of-Load Synchronous Buck Converter for Applications in Networking, Telecom and Computing Systems
- Optimized for Control FET Applications

## DESCRIPTION

The NexFET™ power MOSFET has been designed to minimize losses in power conversion applications.

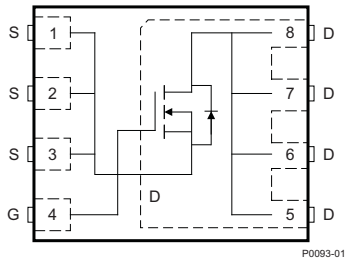
**Top View**

## PRODUCT SUMMARY

$V_{DS}$	Drain to Source Voltage	25	V
$Q_g$	Gate Charge Total (4.5V)	6.5	nC
$Q_{gd}$	Gate Charge Gate to Drain	1.7	nC
$R_{DS(on)}$	Drain to Source On Resistance	$V_{GS} = 4.5V$	5.7 m $\Omega$
		$V_{GS} = 10V$	4.1 m $\Omega$
$V_{GS(th)}$	Threshold Voltage	1.8	V

## ORDERING INFORMATION

Device	Package	Media	Qty	Ship
CSD16404Q5A	SON 5-mm x 6-mm Plastic Package	13-Inch Reel	2500	Tape and Reel

## ABSOLUTE MAXIMUM RATINGS

$T_A = 25^\circ\text{C}$ unless otherwise stated		VALUE	UNIT
$V_{DS}$	Drain to Source Voltage	25	V
$V_{GS}$	Gate to Source Voltage	+16 / -12	V
$I_D$	Continuous Drain Current, $T_C = 25^\circ\text{C}$	81	A
	Continuous Drain Current <sup>(1)</sup>	21	A
$I_{DM}$	Pulsed Drain Current, $T_A = 25^\circ\text{C}$ <sup>(2)</sup>	135	A
$P_D$	Power Dissipation <sup>(1)</sup>	3	W
$T_J, T_{STG}$	Operating Junction and Storage Temperature Range	-55 to 150	$^\circ\text{C}$
$E_{AS}$	Avalanche Energy, single pulse $I_D = 40A, L = 0.1mH, R_G = 25\Omega$	80	mJ

(1)  $R_{\theta JA} = 41^\circ\text{C/W}$  on 1-inch<sup>2</sup> (6.45-cm<sup>2</sup>), 2-oz. (0.071-mm thick) Cu pad on a 0.06-inch (1.52-mm) thick FR4 PCB.

(2) Pulse duration  $\leq 300\mu\text{s}$ , duty cycle  $\leq 2\%$

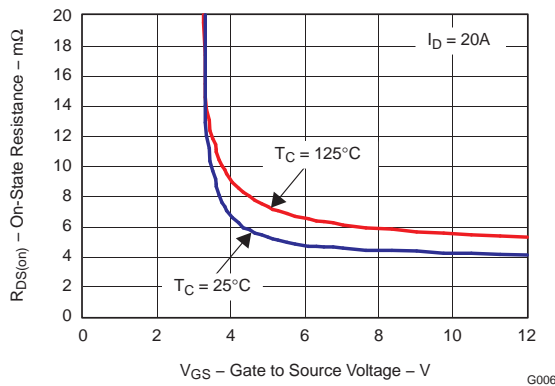
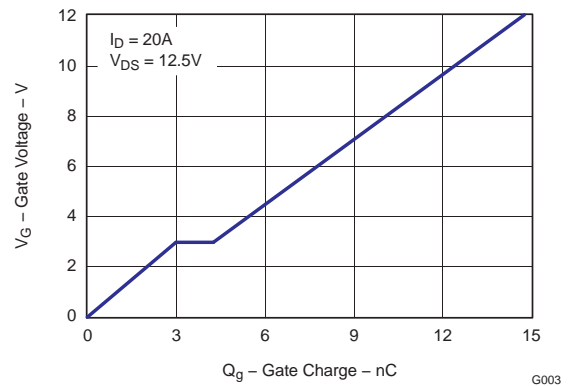
 **$R_{DS(on)}$  vs  $V_{GS}$** 

**GATE CHARGE**

Please be aware that an important notice concerning availability, standard warranty, and use in critical applications of Texas Instruments semiconductor products and disclaimers thereto appears at the end of this data sheet.

NexFET is a trademark of Texas Instruments.



These devices have limited built-in ESD protection. The leads should be shorted together or the device placed in conductive foam during storage or handling to prevent electrostatic damage to the MOS gates.

## ELECTRICAL CHARACTERISTICS

$T_A = 25^\circ\text{C}$ , unless otherwise specified

PARAMETER		TEST CONDITIONS	MIN	TYP	MAX	UNIT
<b>Static Characteristics</b>						
$BV_{DSS}$	Drain to Source Voltage	$V_{GS} = 0V, I_D = 250\mu A$	25			V
$I_{DSS}$	Drain to Source Leakage Current	$V_{GS} = 0V, V_{DS} = 20V$			1	$\mu A$
$I_{GSS}$	Gate to Source Leakage Current	$V_{DS} = 0V, V_{GS} = +16/-12V$			100	nA
$V_{GS(th)}$	Gate to Source Threshold Voltage	$V_{DS} = V_{GS}, I_D = 250\mu A$	1.4	1.8	2.1	V
$R_{DS(on)}$	Drain to Source On Resistance	$V_{GS} = 4.5V, I_D = 20A$		5.7	7.2	m $\Omega$
		$V_{GS} = 10V, I_D = 20A$		4.1	5.1	m $\Omega$
$g_{fs}$	Transconductance	$V_{DS} = 15V, I_D = 20A$		57		S
<b>Dynamic Characteristics</b>						
$C_{ISS}$	Input Capacitance	$V_{GS} = 0V, V_{DS} = 12.5V, f = 1MHz$		940	1220	pF
$C_{OSS}$	Output Capacitance			810	1050	pF
$C_{RSS}$	Reverse Transfer Capacitance			62	80	pF
$R_g$	Series Gate Resistance			0.9	1.8	$\Omega$
$Q_g$	Gate Charge Total (4.5V)	$V_{DS} = 12.5V, I_D = 20A$		6.5	8.5	nC
$Q_{gd}$	Gate Charge Gate to Drain			1.7		nC
$Q_{gs}$	Gate Charge Gate to Source			3		nC
$Q_{g(th)}$	Gate Charge at $V_{th}$			1.5		nC
$Q_{OSS}$	Output Charge	$V_{DS} = 13V, V_{GS} = 0V$		16		nC
$t_{d(on)}$	Turn On Delay Time	$V_{DS} = 12.5V, V_{GS} = 4.5V, I_D = 20A, R_G = 2\Omega$		7.8		ns
$t_r$	Rise Time			13.4		ns
$t_{d(off)}$	Turn Off Delay Time			8.4		ns
$t_f$	Fall Time			4.6		ns
<b>Diode Characteristics</b>						
$V_{SD}$	Diode Forward Voltage	$I_S = 20A, V_{GS} = 0V$		0.85	1	V
$Q_{rr}$	Reverse Recovery Charge	$V_{DD} = 13V, I_F = 20A, di/dt = 300A/\mu s$		20		nC
$t_{rr}$	Reverse Recovery Time	$V_{DD} = 13V, I_F = 20A, di/dt = 300A/\mu s$		22		ns

## THERMAL CHARACTERISTICS

$T_A = 25^\circ\text{C}$ , unless otherwise specified

PARAMETER		MIN	TYP	MAX	UNIT
$R_{\theta JC}$	Thermal Resistance Junction to Case <sup>(1)</sup>			3.3	$^\circ\text{C}/\text{W}$
$R_{\theta JA}$	Thermal Resistance Junction to Ambient <sup>(1) (2)</sup>			52	$^\circ\text{C}/\text{W}$

- $R_{\theta JC}$  is determined with the device mounted on a 1-inch<sup>2</sup> (6.45-cm<sup>2</sup>), 2-oz. (0.071-mm thick) Cu pad on a 1.5-inch x 1.5-inch (3.81-cm x 3.81-cm), 0.06-inch (1.52-mm) thick FR4 PCB.  $R_{\theta JC}$  is specified by design, whereas  $R_{\theta JA}$  is determined by the user's board design.
- Device mounted on FR4 material with 1-inch<sup>2</sup> (6.45-cm<sup>2</sup>), 2-oz. (0.071-mm thick) Cu.

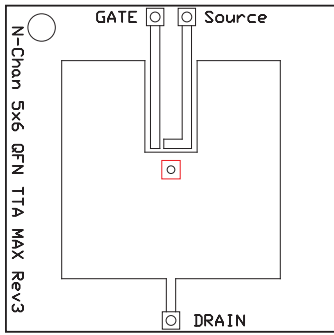

M0137-01

Max  $R_{\theta JA} = 52^{\circ}\text{C/W}$   
 when mounted on  
 1 inch<sup>2</sup> (6.45 cm<sup>2</sup>) of  
 2-oz. (0.071-mm thick)  
 Cu.

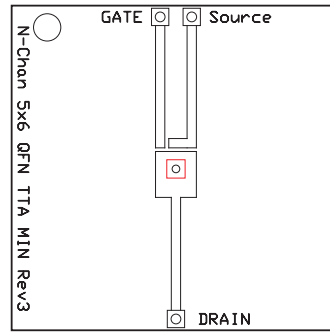

M0137-02

Max  $R_{\theta JA} = 120^{\circ}\text{C/W}$   
 when mounted on  
 minimum pad area of  
 2-oz. (0.071-mm thick)  
 Cu.

### TYPICAL MOSFET CHARACTERISTICS

$T_A = 25^{\circ}\text{C}$ , unless otherwise specified

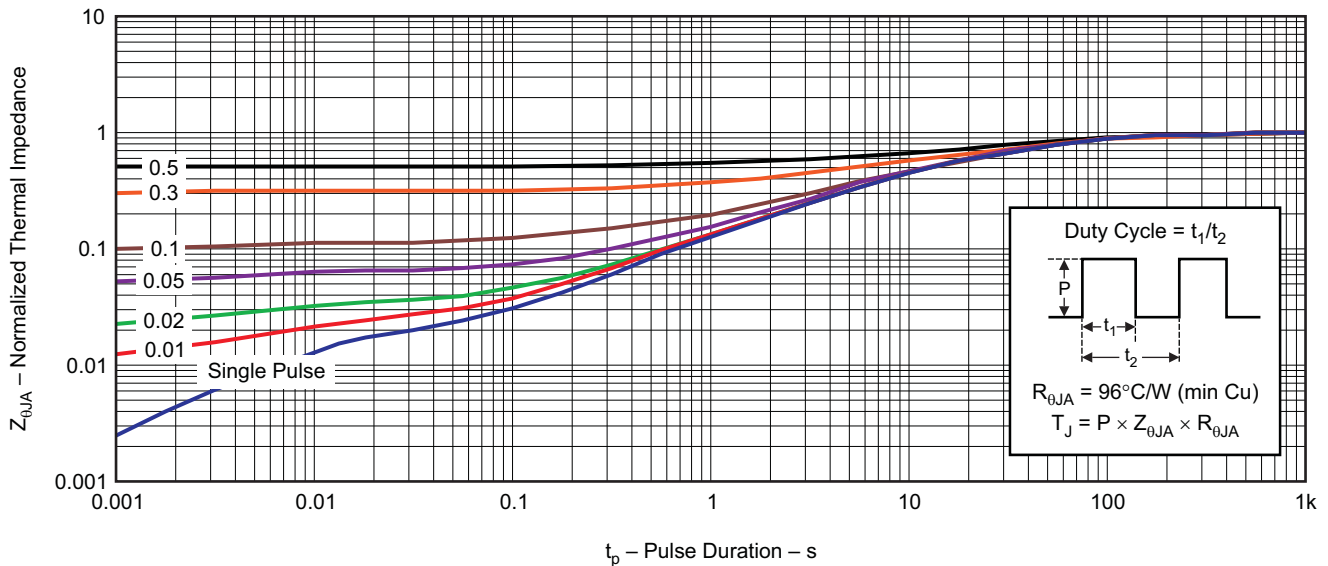

G012

Figure 1. Transient Thermal Impedance

**TYPICAL MOSFET CHARACTERISTICS (continued)**

$T_A = 25^\circ\text{C}$ , unless otherwise specified

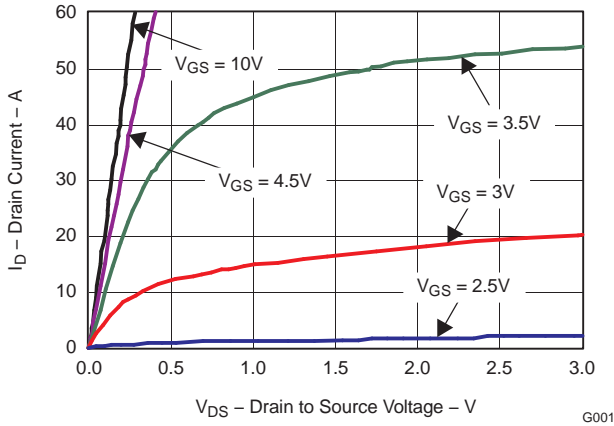

**Figure 2. Saturation Characteristics**

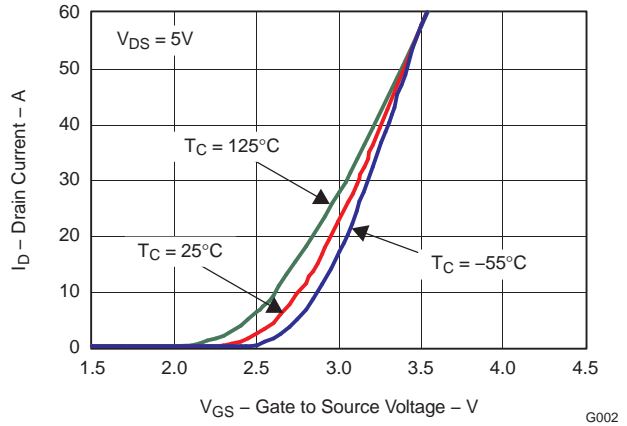

**Figure 3. Transfer Characteristics**

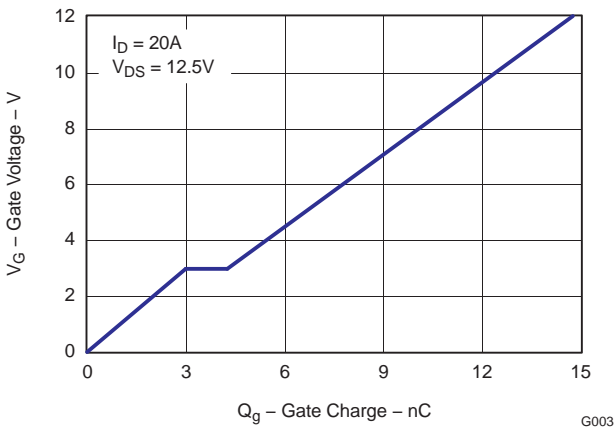

**Figure 4. Gate Charge**

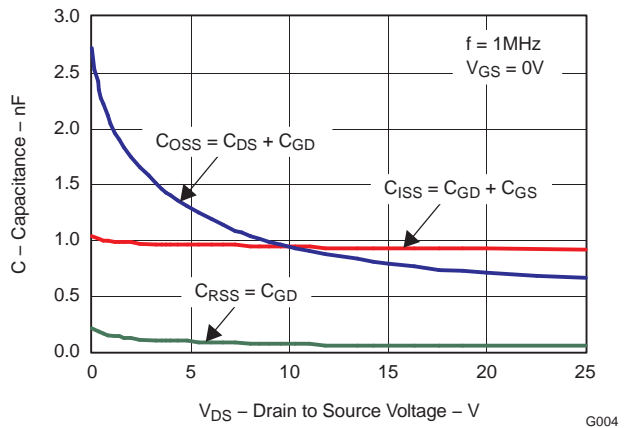

**Figure 5. Capacitance**

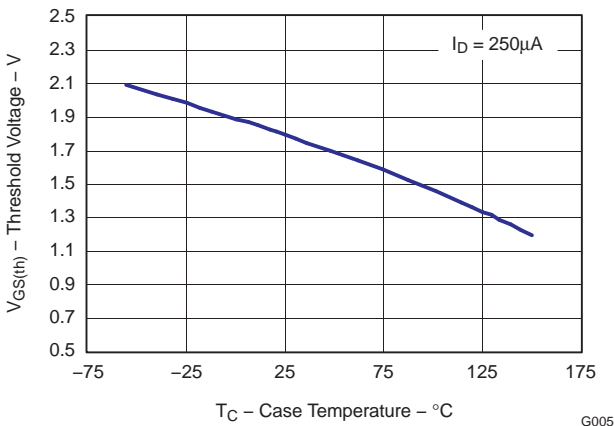

**Figure 6. Threshold Voltage vs. Temperature**

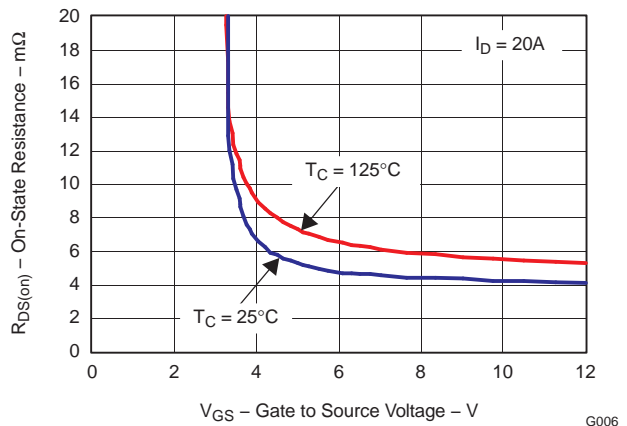

**Figure 7. On-State Resistance vs. Gate to Source Voltage**

TYPICAL MOSFET CHARACTERISTICS (continued)

T<sub>A</sub> = 25°C, unless otherwise specified

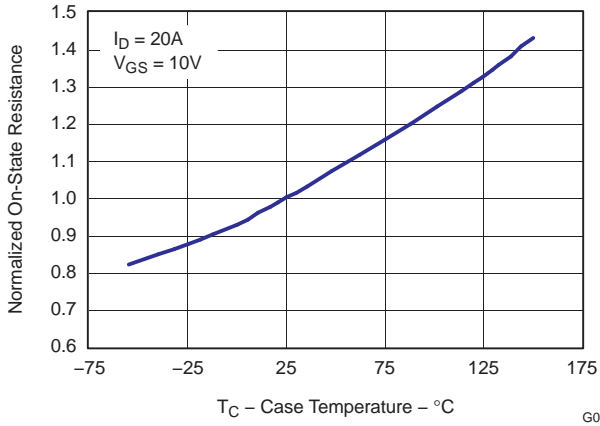

Figure 8. Normalized On-State Resistance vs. Temperature

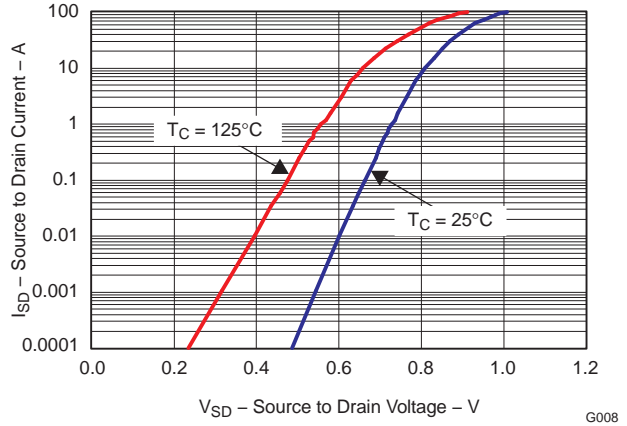

Figure 9. Typical Diode Forward Voltage

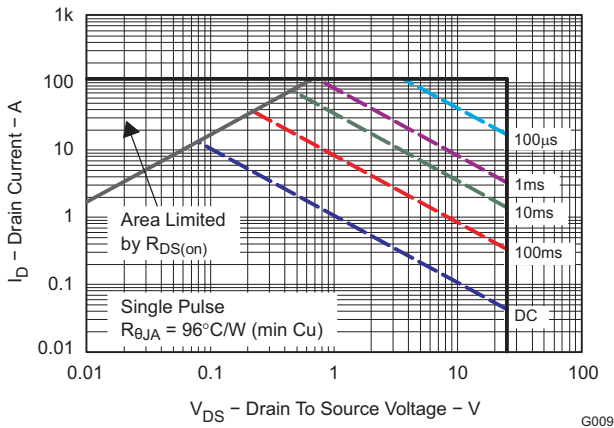

Figure 10. Maximum Safe Operating Area

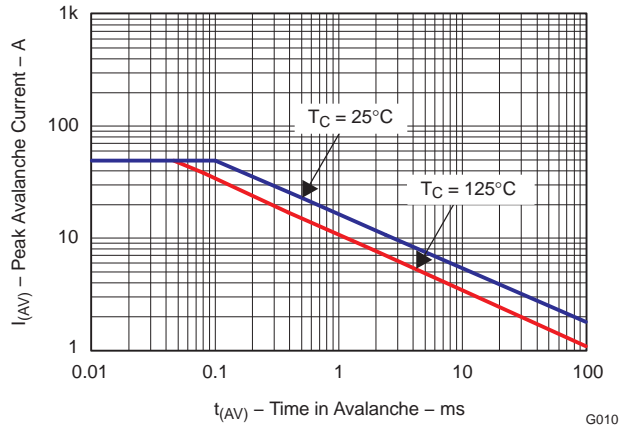

Figure 11. Single Pulse Unclamped Inductive Switching

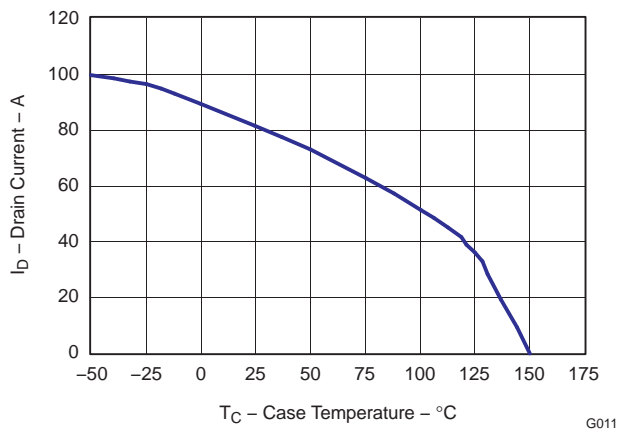
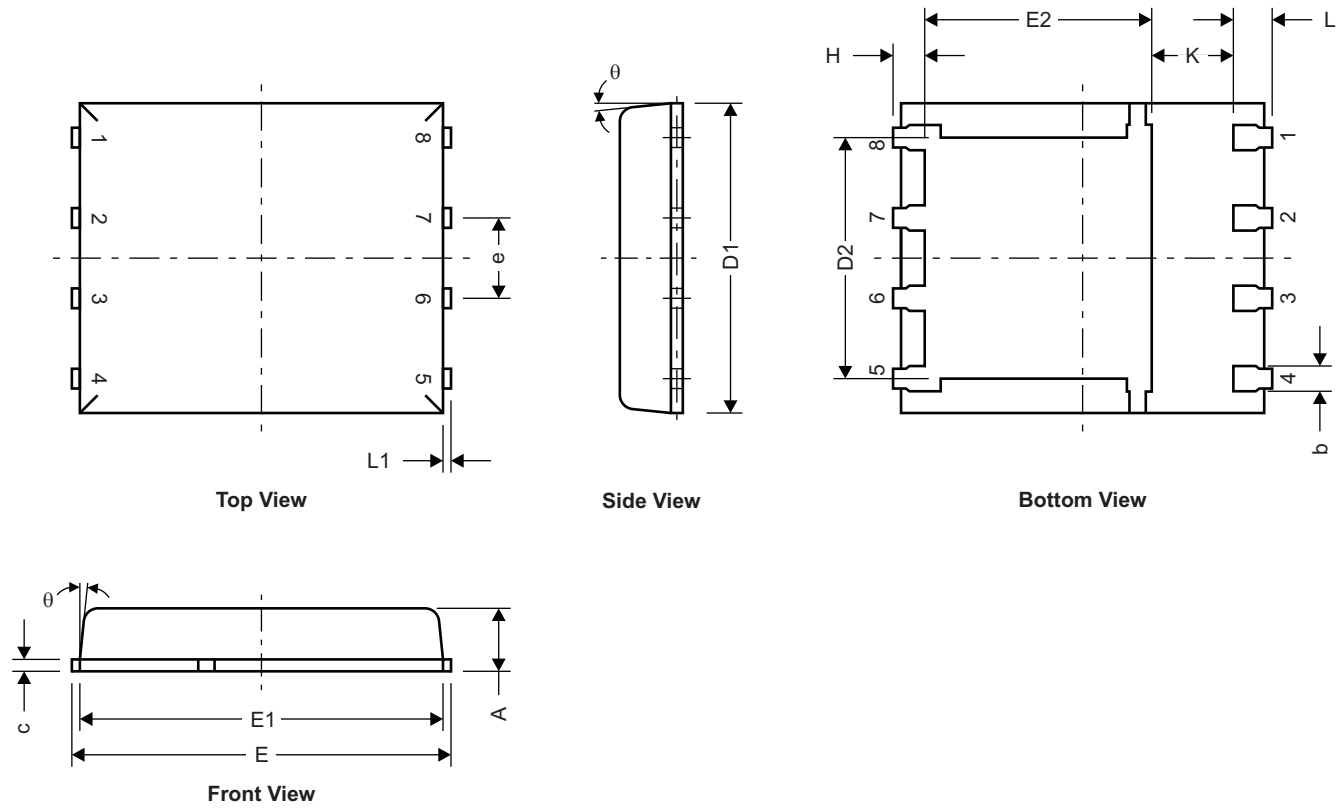

Figure 12. Maximum Drain Current vs. Temperature

**MECHANICAL DATA**

**Q5A Package Dimensions**



M0135-01

DIM	MILLIMETERS		
	MIN	NOM	MAX
A	0.90	1.00	1.10
b	0.33	0.41	0.51
c	0.20	0.25	0.30
D1	4.80	4.90	5.00
D2	3.61	3.81	3.96
E	5.90	6.00	6.10
E1	5.70	5.75	5.80
E2	3.38	3.58	3.78
e	1.27 BSC		
H	0.41	0.51	0.61
K	1.10		
L	0.51	0.61	0.71
L1	0.06	0.13	0.20
$\theta$	0°		12°

Recommended PCB Pattern

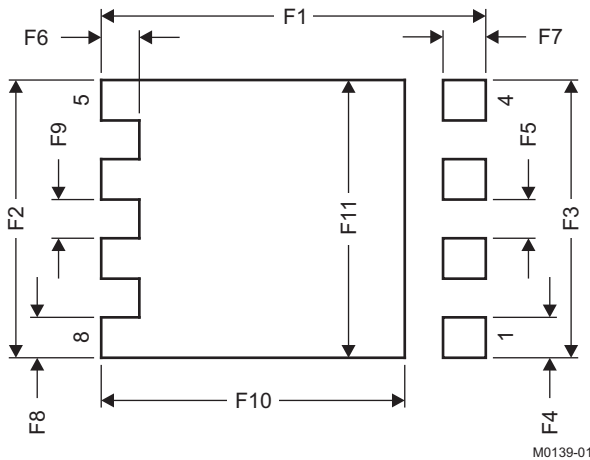

DIM	MILLIMETERS		INCHES	
	MIN	MAX	MIN	MAX
F1	6.205	6.305	0.244	0.248
F2	4.46	4.56	0.176	0.18
F3	4.46	4.56	0.176	0.18
F4	0.65	0.7	0.026	0.028
F5	0.62	0.67	0.024	0.026
F6	0.63	0.68	0.025	0.027
F7	0.7	0.8	0.028	0.031
F8	0.65	0.7	0.026	0.028
F9	0.62	0.67	0.024	0.026
F10	4.9	5	0.193	0.197
F11	4.46	4.56	0.176	0.18

For recommended circuit layout for PCB designs, see application note [SLPA005 – Reducing Ringing Through PCB Layout Techniques](#).

Q5A Tape and Reel Information

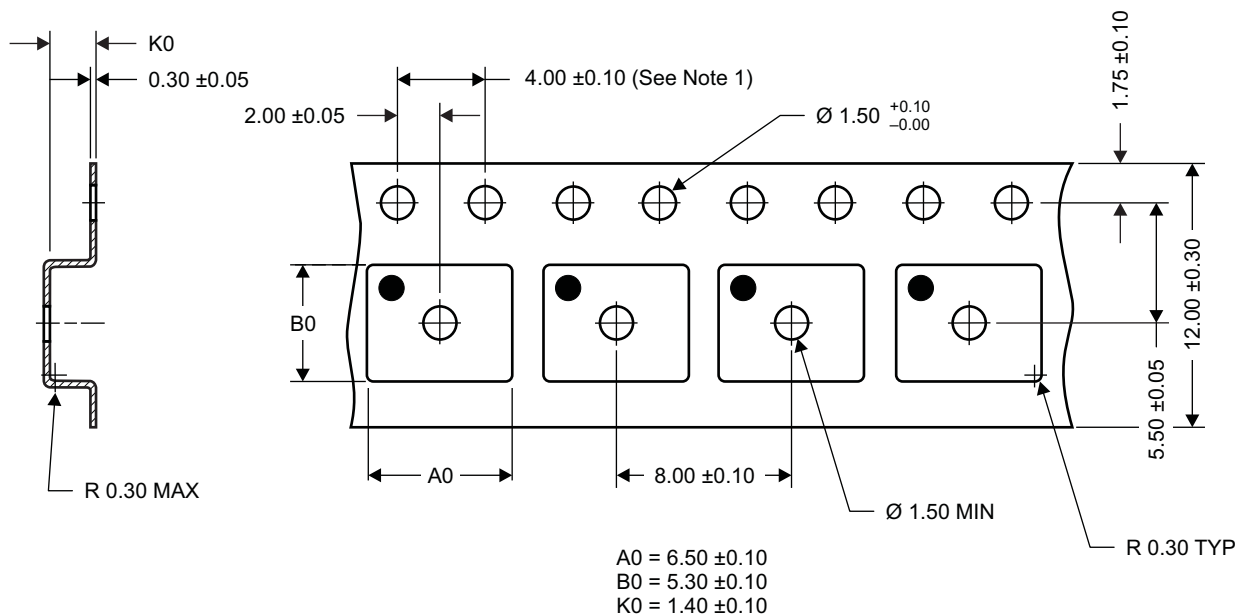

- Notes:
- 10-sprocket hole-pitch cumulative tolerance  $\pm 0.22$
  - Camber not to exceed 1mm in 100mm, noncumulative over 250mm
  - Material: black static-dissipative polystyrene
  - All dimensions are in mm, unless otherwise specified.
  - A0 and B0 measured on a plane 0.3mm above the bottom of the pocket
  - MSL1 260°C (IR and convection) PbF reflow compatible

M0138-01

## REVISION HISTORY

---

**Changes from Original (August 2009) to Revision A** **Page**

- Changed [Figure 10](#) - Maximum Safe Operating Area, Drain Current top scale From: 100ms To: 100 $\mu$ s ..... **5**
- 

**Changes from Revision A (September 2009) to Revision B** **Page**

- Deleted the Package Marking Information section ..... **7**
-



**TAPE AND REEL INFORMATION**

**REEL DIMENSIONS**

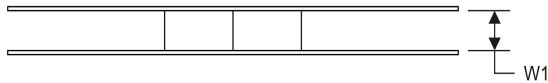

**TAPE DIMENSIONS**

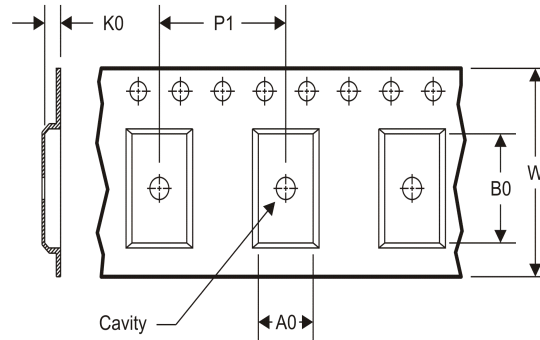

A0	Dimension designed to accommodate the component width
B0	Dimension designed to accommodate the component length
K0	Dimension designed to accommodate the component thickness
W	Overall width of the carrier tape
P1	Pitch between successive cavity centers

**TAPE AND REEL INFORMATION**

\*All dimensions are nominal

Device	Package Type	Package Drawing	Pins	SPQ	Reel Diameter (mm)	Reel Width W1 (mm)	A0 (mm)	B0 (mm)	K0 (mm)	P1 (mm)	W (mm)	Pin1 Quadrant
CSD16404Q5A	SON	DQJ	8	2500	330.0	12.4	6.3	5.3	1.2	8.0	12.0	Q1

**TAPE AND REEL BOX DIMENSIONS**



\*All dimensions are nominal

Device	Package Type	Package Drawing	Pins	SPQ	Length (mm)	Width (mm)	Height (mm)
CSD16404Q5A	SON	DQJ	8	2500	340.0	340.0	38.0

## IMPORTANT NOTICE

Texas Instruments Incorporated and its subsidiaries (TI) reserve the right to make corrections, enhancements, improvements and other changes to its semiconductor products and services per JESD46, latest issue, and to discontinue any product or service per JESD48, latest issue. Buyers should obtain the latest relevant information before placing orders and should verify that such information is current and complete. All semiconductor products (also referred to herein as "components") are sold subject to TI's terms and conditions of sale supplied at the time of order acknowledgment.

TI warrants performance of its components to the specifications applicable at the time of sale, in accordance with the warranty in TI's terms and conditions of sale of semiconductor products. Testing and other quality control techniques are used to the extent TI deems necessary to support this warranty. Except where mandated by applicable law, testing of all parameters of each component is not necessarily performed.

TI assumes no liability for applications assistance or the design of Buyers' products. Buyers are responsible for their products and applications using TI components. To minimize the risks associated with Buyers' products and applications, Buyers should provide adequate design and operating safeguards.

TI does not warrant or represent that any license, either express or implied, is granted under any patent right, copyright, mask work right, or other intellectual property right relating to any combination, machine, or process in which TI components or services are used. Information published by TI regarding third-party products or services does not constitute a license to use such products or services or a warranty or endorsement thereof. Use of such information may require a license from a third party under the patents or other intellectual property of the third party, or a license from TI under the patents or other intellectual property of TI.

Reproduction of significant portions of TI information in TI data books or data sheets is permissible only if reproduction is without alteration and is accompanied by all associated warranties, conditions, limitations, and notices. TI is not responsible or liable for such altered documentation. Information of third parties may be subject to additional restrictions.

Resale of TI components or services with statements different from or beyond the parameters stated by TI for that component or service voids all express and any implied warranties for the associated TI component or service and is an unfair and deceptive business practice. TI is not responsible or liable for any such statements.

Buyer acknowledges and agrees that it is solely responsible for compliance with all legal, regulatory and safety-related requirements concerning its products, and any use of TI components in its applications, notwithstanding any applications-related information or support that may be provided by TI. Buyer represents and agrees that it has all the necessary expertise to create and implement safeguards which anticipate dangerous consequences of failures, monitor failures and their consequences, lessen the likelihood of failures that might cause harm and take appropriate remedial actions. Buyer will fully indemnify TI and its representatives against any damages arising out of the use of any TI components in safety-critical applications.

In some cases, TI components may be promoted specifically to facilitate safety-related applications. With such components, TI's goal is to help enable customers to design and create their own end-product solutions that meet applicable functional safety standards and requirements. Nonetheless, such components are subject to these terms.

No TI components are authorized for use in FDA Class III (or similar life-critical medical equipment) unless authorized officers of the parties have executed a special agreement specifically governing such use.

Only those TI components which TI has specifically designated as military grade or "enhanced plastic" are designed and intended for use in military/aerospace applications or environments. Buyer acknowledges and agrees that any military or aerospace use of TI components which have **not** been so designated is solely at the Buyer's risk, and that Buyer is solely responsible for compliance with all legal and regulatory requirements in connection with such use.

TI has specifically designated certain components which meet ISO/TS16949 requirements, mainly for automotive use. Components which have not been so designated are neither designed nor intended for automotive use; and TI will not be responsible for any failure of such components to meet such requirements.

### Products

Audio	<a href="http://www.ti.com/audio">www.ti.com/audio</a>
Amplifiers	<a href="http://amplifier.ti.com">amplifier.ti.com</a>
Data Converters	<a href="http://dataconverter.ti.com">dataconverter.ti.com</a>
DLP® Products	<a href="http://www.dlp.com">www.dlp.com</a>
DSP	<a href="http://dsp.ti.com">dsp.ti.com</a>
Clocks and Timers	<a href="http://www.ti.com/clocks">www.ti.com/clocks</a>
Interface	<a href="http://interface.ti.com">interface.ti.com</a>
Logic	<a href="http://logic.ti.com">logic.ti.com</a>
Power Mgmt	<a href="http://power.ti.com">power.ti.com</a>
Microcontrollers	<a href="http://microcontroller.ti.com">microcontroller.ti.com</a>
RFID	<a href="http://www.ti-rfid.com">www.ti-rfid.com</a>
OMAP Applications Processors	<a href="http://www.ti.com/omap">www.ti.com/omap</a>
Wireless Connectivity	<a href="http://www.ti.com/wirelessconnectivity">www.ti.com/wirelessconnectivity</a>

### Applications

Automotive and Transportation	<a href="http://www.ti.com/automotive">www.ti.com/automotive</a>
Communications and Telecom	<a href="http://www.ti.com/communications">www.ti.com/communications</a>
Computers and Peripherals	<a href="http://www.ti.com/computers">www.ti.com/computers</a>
Consumer Electronics	<a href="http://www.ti.com/consumer-apps">www.ti.com/consumer-apps</a>
Energy and Lighting	<a href="http://www.ti.com/energy">www.ti.com/energy</a>
Industrial	<a href="http://www.ti.com/industrial">www.ti.com/industrial</a>
Medical	<a href="http://www.ti.com/medical">www.ti.com/medical</a>
Security	<a href="http://www.ti.com/security">www.ti.com/security</a>
Space, Avionics and Defense	<a href="http://www.ti.com/space-avionics-defense">www.ti.com/space-avionics-defense</a>
Video and Imaging	<a href="http://www.ti.com/video">www.ti.com/video</a>

### TI E2E Community

[e2e.ti.com](http://e2e.ti.com)