



STP6NK50Z - STF6NK50Z STD6NK50Z

N-CHANNEL 500V - 0.93Ω - 5.6A TO-220/TO-220FP/DPAK
Zener-Protected SuperMESH™ MOSFET

TYPE	V _{DSS}	R _{DS(on)}	I _D	P _w
STP6NK50Z	500 V	< 1.2 Ω	5.6 A	90 W
STF6NK50Z	500 V	< 1.2 Ω	5.6 A	25 W
STD6NK50Z	500 V	< 1.2 Ω	5.6 A	90 W

- TYPICAL R_{DS(on)} = 0.93 Ω
- EXTREMELY HIGH dv/dt CAPABILITY
- 100% AVALANCHE TESTED
- GATE CHARGE MINIMIZED
- VERY LOW INTRINSIC CAPACITANCES
- VERY GOOD MANUFACTURING REPEATABILITY

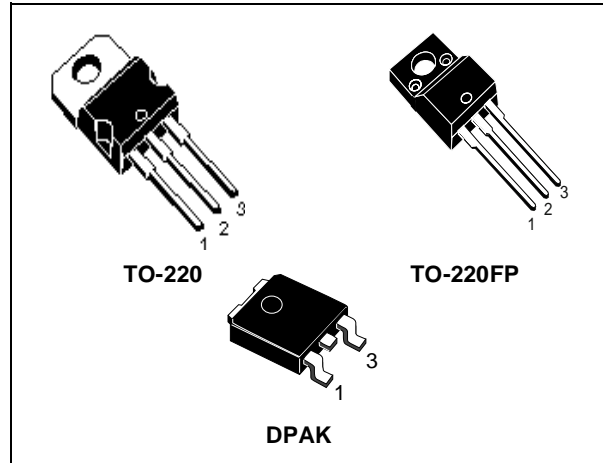

DESCRIPTION

The SuperMESH™ series is obtained through an extreme optimization of ST's well established strip-based PowerMESH™ layout. In addition to pushing on-resistance significantly down, special care is taken to ensure a very good dv/dt capability for the most demanding applications. Such series complements ST full range of high voltage MOSFETs including revolutionary MDmesh™ products.

APPLICATIONS

- HIGH CURRENT, HIGH SPEED SWITCHING
- IDEAL FOR OFF-LINE POWER SUPPLIES, ADAPTORS AND PFC
- LIGHTING

INTERNAL SCHEMATIC DIAGRAM

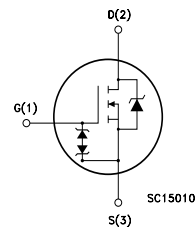

ORDER CODES

PART NUMBER	MARKING	PACKAGE	PACKAGING
STP6NK50Z	P6NK50Z	TO-220	TUBE
STF6NK50Z	F6NK50Z	TO-220FP	TUBE
STD6NK50ZT4	D6NK50Z	DPAK	TAPE & REEL

STP6NK50Z - STF6NK50Z - STD6NK50Z

ABSOLUTE MAXIMUM RATINGS

Symbol	Parameter	Value		Unit
		STP6NK50Z STD6NK50Z	STF6NK50Z	
V_{DS}	Drain-source Voltage ($V_{GS} = 0$)	500		V
V_{DGR}	Drain-gate Voltage ($R_{GS} = 20\text{ k}\Omega$)	500		V
V_{GS}	Gate- source Voltage	± 30		V
I_D	Drain Current (continuous) at $T_C = 25^\circ\text{C}$	5.6	5.6 (*)	A
I_D	Drain Current (continuous) at $T_C = 100^\circ\text{C}$	3.5	3.5 (*)	A
$I_{DM}(\bullet)$	Drain Current (pulsed)	22.4	22.4 (*)	A
P_{TOT}	Total Dissipation at $T_C = 25^\circ\text{C}$	90	25	W
	Derating Factor	0.72	0.2	W/ $^\circ\text{C}$
$V_{ESD(G-S)}$	Gate source ESD(HBM-C=100pF, R=1.5K Ω)	3000		V
dv/dt (1)	Peak Diode Recovery voltage slope	4.5		V/ns
V_{ISO}	Insulation Withstand Voltage (DC)	-	2500	V
T_j T_{stg}	Operating Junction Temperature Storage Temperature	-55 to 150		$^\circ\text{C}$

(●) Pulse width limited by safe operating area

(1) $I_{SD} \leq 5.6\text{A}$, $di/dt \leq 200\text{ A}/\mu\text{s}$, $V_{DD} \leq V_{(BR)DSS}$, $T_j \leq T_{JMAX}$.

(*) Limited only by maximum temperature allowed

THERMAL DATA

		TO-220 DPAK	TO-220FP	
Rthj-case	Thermal Resistance Junction-case Max	1.38	5	$^\circ\text{C}/\text{W}$
Rthj-amb	Thermal Resistance Junction-ambient Max	62.5		$^\circ\text{C}/\text{W}$
T_l	Maximum Lead Temperature For Soldering Purpose	300		$^\circ\text{C}$

AVALANCHE CHARACTERISTICS

Symbol	Parameter	Max Value	Unit
I_{AR}	Avalanche Current, Repetitive or Not-Repetitive (pulse width limited by T_j max)	5.6	A
E_{AS}	Single Pulse Avalanche Energy (starting $T_j = 25^\circ\text{C}$, $I_D = I_{AR}$, $V_{DD} = 50\text{ V}$)	180	mJ

GATE-SOURCE ZENER DIODE

Symbol	Parameter	Test Conditions	Min.	Typ.	Max.	Unit
BV_{GSO}	Gate-Source Breakdown Voltage	$I_{gs} = \pm 1\text{ mA}$ (Open Drain)	30			V

PROTECTION FEATURES OF GATE-TO-SOURCE ZENER DIODES

The built-in back-to-back Zener diodes have specifically been designed to enhance not only the device's ESD capability, but also to make them safely absorb possible voltage transients that may occasionally be applied from gate to source. In this respect the Zener voltage is appropriate to achieve an efficient and cost-effective intervention to protect the device's integrity. These integrated Zener diodes thus avoid the usage of external components.

STP6NK50Z - STF6NK50Z - STD6NK50Z

ELECTRICAL CHARACTERISTICS (T_{CASE} = 25°C UNLESS OTHERWISE SPECIFIED) ON/OFF

Symbol	Parameter	Test Conditions	Min.	Typ.	Max.	Unit
V _{(BR)DSS}	Drain-source Breakdown Voltage	I _D = 1 mA, V _{GS} = 0	500			V
I _{DSS}	Zero Gate Voltage Drain Current (V _{GS} = 0)	V _{DS} = Max Rating V _{DS} = Max Rating, T _C = 125 °C			1 50	μA μA
I _{GSS}	Gate-body Leakage Current (V _{DS} = 0)	V _{GS} = ± 20V			±10	μA
V _{GS(th)}	Gate Threshold Voltage	V _{DS} = V _{GS} , I _D = 50μA	3	3.75	4.5	V
R _{DSON}	Static Drain-source On Resistance	V _{GS} = 10V, I _D = 2.8 A		0.93	1.2	Ω

DYNAMIC

Symbol	Parameter	Test Conditions	Min.	Typ.	Max.	Unit
g _{fs} (1)	Forward Transconductance	V _{DS} = 8 V, I _D = 2.8 A		4.3		S
C _{iss} C _{oss} C _{rss}	Input Capacitance Output Capacitance Reverse Transfer Capacitance	V _{DS} = 25V, f = 1 MHz, V _{GS} = 0		690 100 20		pF pF pF
C _{oss eq.} (3)	Equivalent Output Capacitance	V _{GS} = 0V, V _{DS} = 0V to 400V		52		pF
t _{d(on)} t _r t _{d(off)} t _f	Turn-on Delay Time Rise Time Turn-off Delay Time Fall Time	V _{DD} = 250 V, I _D = 2.8 A R _G = 4.7Ω V _{GS} = 10 V (Resistive Load see, Figure 3)		12 23.5 31 23		ns ns ns ns
Q _g Q _{gs} Q _{gd}	Total Gate Charge Gate-Source Charge Gate-Drain Charge	V _{DD} = 400V, I _D = 5.6 A, V _{GS} = 10V		24.6 4.9 13.3		nC nC nC

SOURCE DRAIN DIODE

Symbol	Parameter	Test Conditions	Min.	Typ.	Max.	Unit
I _{SD} I _{SDM} (2)	Source-drain Current Source-drain Current (pulsed)				5.6 22.4	A A
V _{SD} (1)	Forward On Voltage	I _{SD} = 5.6 A, V _{GS} = 0			1.6	V
t _{rr} Q _{rr} I _{RRM}	Reverse Recovery Time Reverse Recovery Charge Reverse Recovery Current	I _{SD} = 5.6 A, di/dt = 100 A/μs V _{DD} = 48V, T _J = 25°C (see test circuit, Figure 5)		254 1.2 10		ns μC A
t _{rr} Q _{rr} I _{RRM}	Reverse Recovery Time Reverse Recovery Charge Reverse Recovery Current	I _{SD} = 5.6 A, di/dt = 100 A/μs V _{DD} = 48V, T _J = 150°C (see test circuit, Figure 5)		360 1.9 11		ns μC A

Note: 1. Pulsed: Pulse duration = 300 μs, duty cycle 1.5 %.

2. Pulse width limited by safe operating area.

3. C_{oss eq.} is defined as a constant equivalent capacitance giving the same charging time as C_{oss} when V_{DS} increases from 0 to 80% V_{DSS}.

Safe Operating Area for TO-220

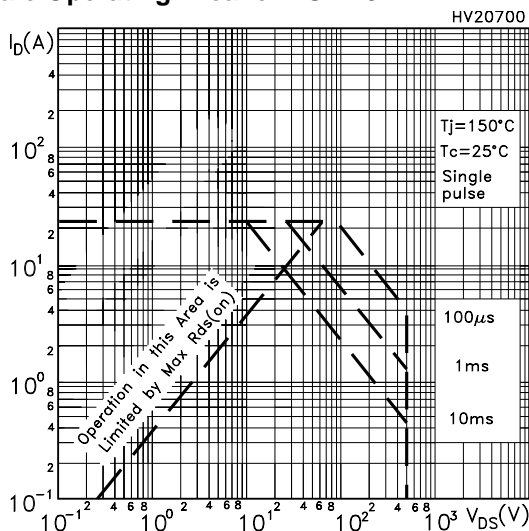

Thermal Impedance for TO-220

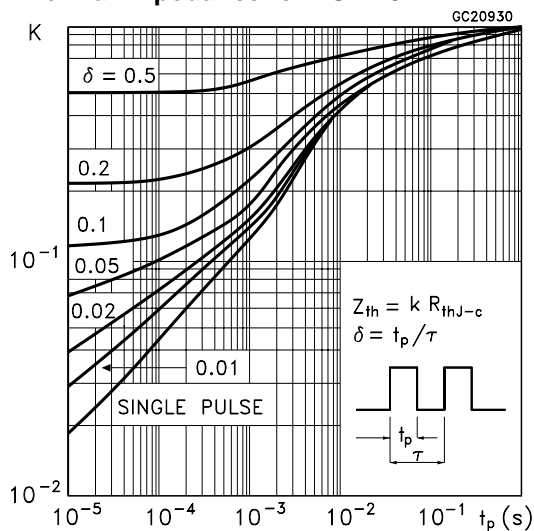

Safe Operating Area for TO-220FP

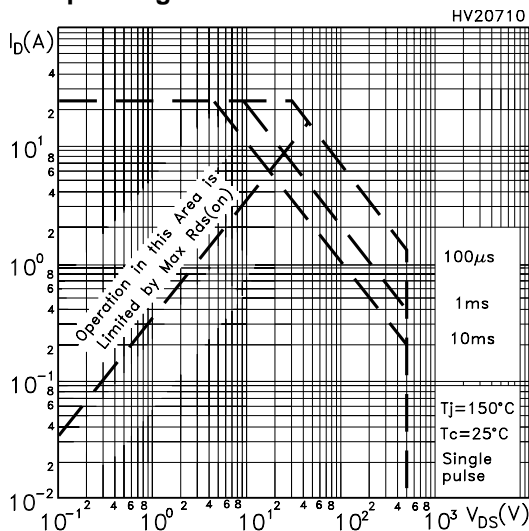

Thermal Impedance for TO-220FP

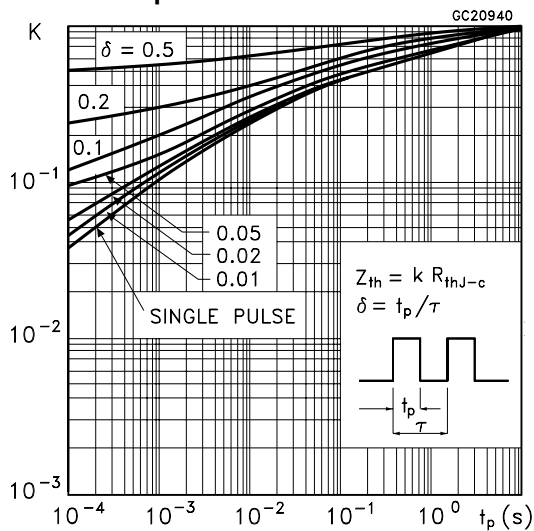

Safe Operating Area for DPAK

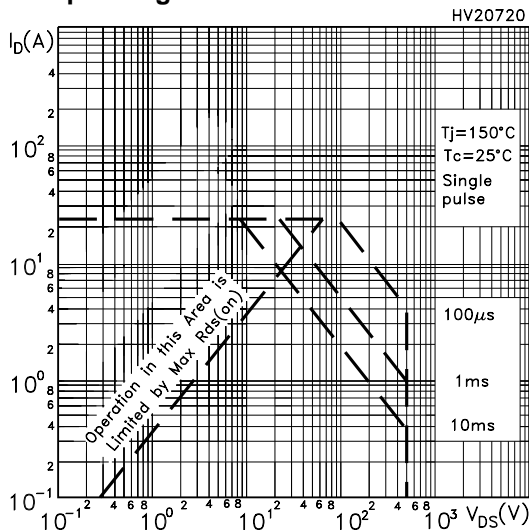

Thermal Impedance for DPAK

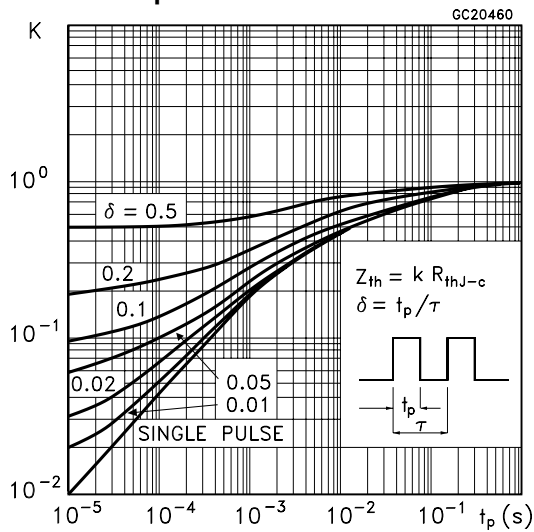

Output Characteristics

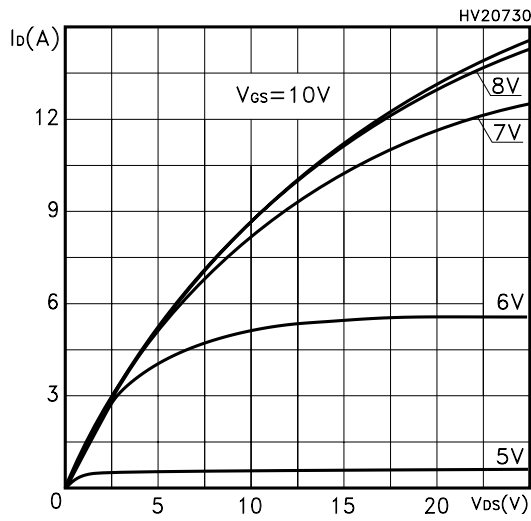

Transfer Characteristics

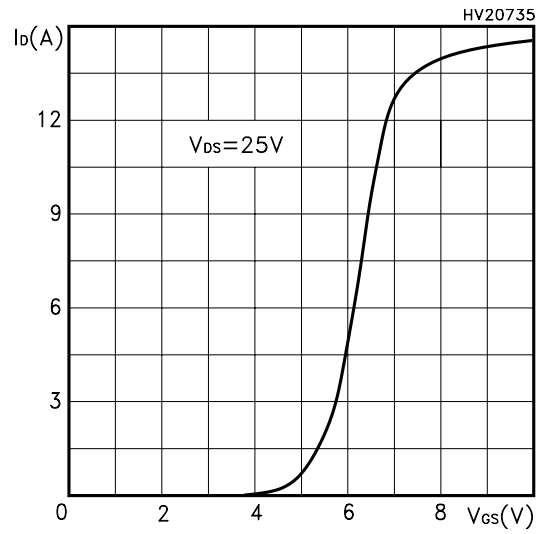

Transconductance

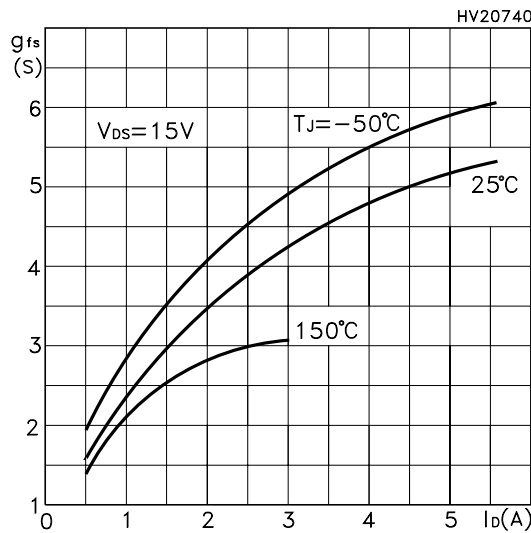

Static Drain-source On Resistance

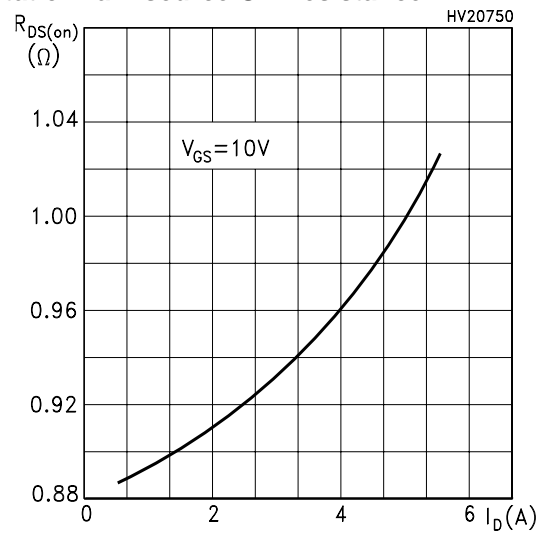

Gate Charge vs Gate-source Voltage

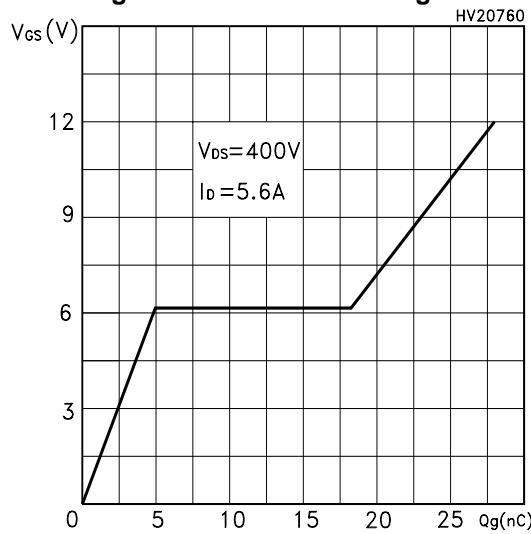

Capacitance Variations

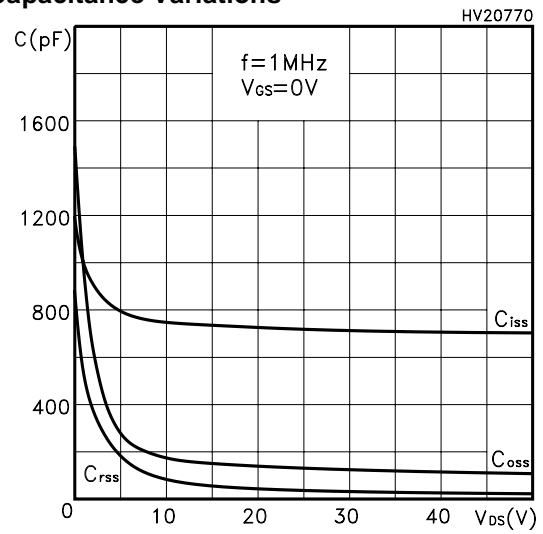

STP6NK50Z - STF6NK50Z - STD6NK50Z

Normalized Gate Threshold Voltage vs Temp.

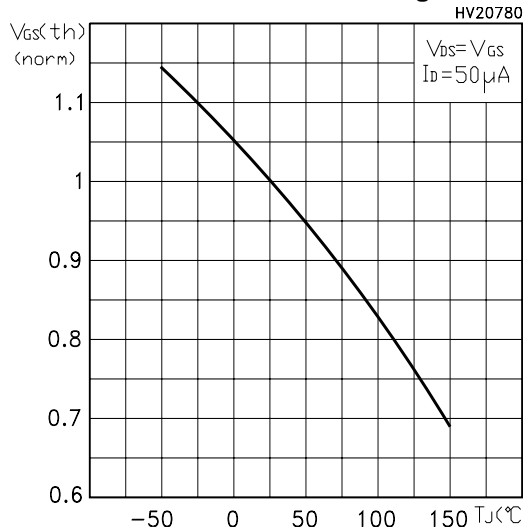

Normalized On Resistance vs Temperature

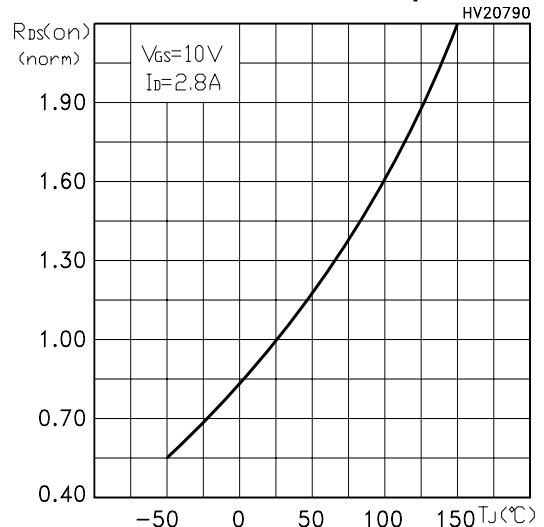

Source-drain Diode Forward Characteristics

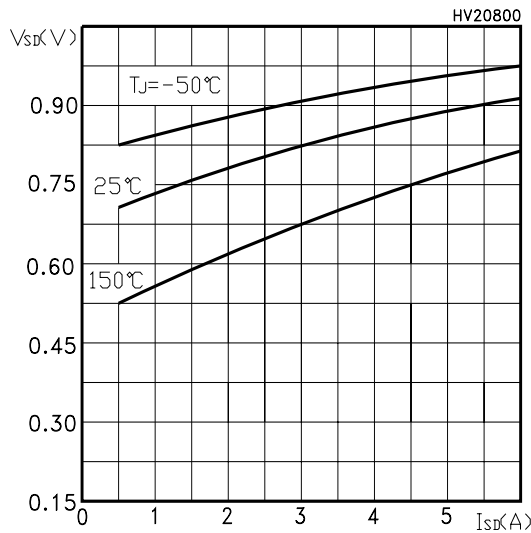

Normalized BVDSS vs Temperature

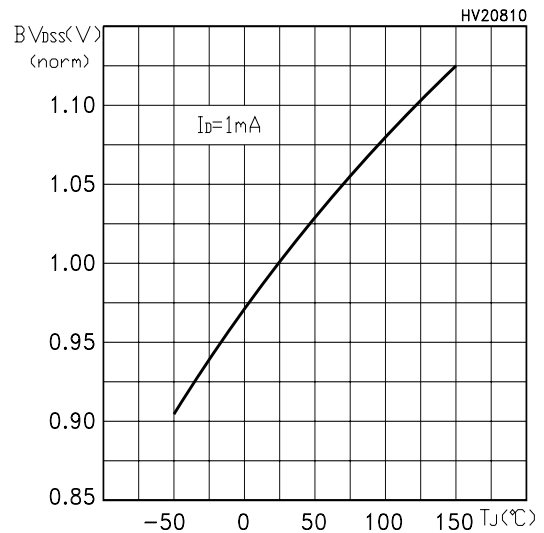

Maximum Avalanche Energy vs Temperature

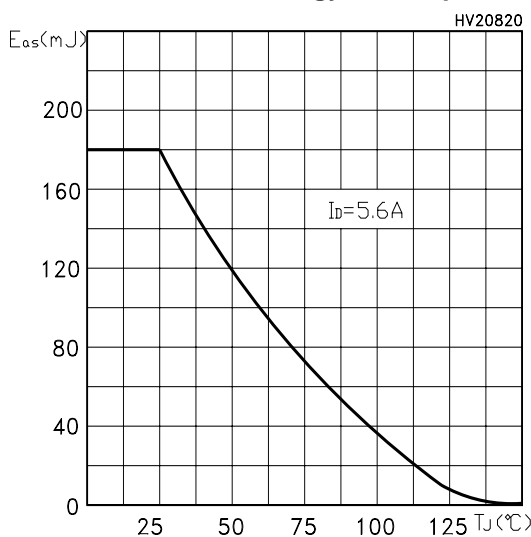

Fig. 1: Unclamped Inductive Load Test Circuit



Fig. 2: Unclamped Inductive Waveform



Fig. 3: Switching Times Test Circuit For Resistive Load



Fig. 4: Gate Charge test Circuit

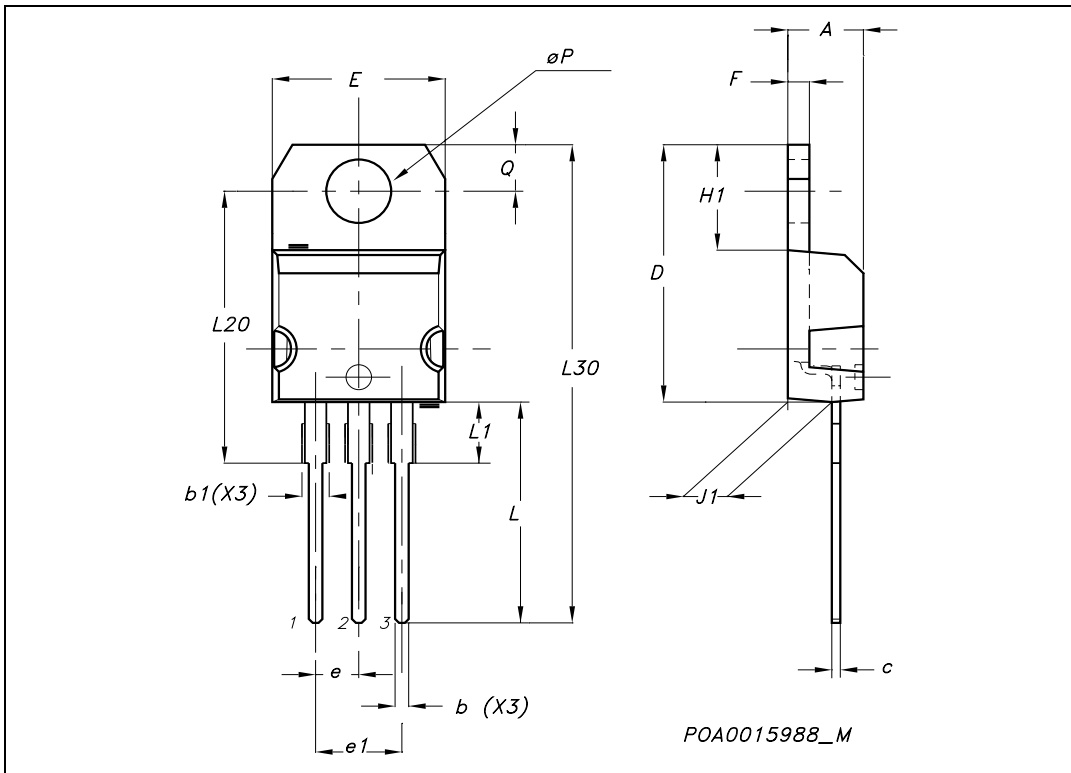

Fig. 5: Test Circuit For Inductive Load Switching And Diode Recovery Times



TO-220 MECHANICAL DATA

DIM.	mm.			inch		
	MIN.	TYP	MAX.	MIN.	TYP.	MAX.
A	4.40		4.60	0.173		0.181
b	0.61		0.88	0.024		0.034
b1	1.15		1.70	0.045		0.066
c	0.49		0.70	0.019		0.027
D	15.25		15.75	0.60		0.620
E	10		10.40	0.393		0.409
e	2.40		2.70	0.094		0.106
e1	4.95		5.15	0.194		0.202
F	1.23		1.32	0.048		0.052
H1	6.20		6.60	0.244		0.256
J1	2.40		2.72	0.094		0.107
L	13		14	0.511		0.551
L1	3.50		3.93	0.137		0.154
L20		16.40			0.645	
L30		28.90			1.137	
øP	3.75		3.85	0.147		0.151
Q	2.65		2.95	0.104		0.116



TO-220FP MECHANICAL DATA

DIM.	mm.			inch		
	MIN.	TYP	MAX.	MIN.	TYP.	MAX.
A	4.4		4.6	0.173		0.181
B	2.5		2.7	0.098		0.106
D	2.5		2.75	0.098		0.108
E	0.45		0.7	0.017		0.027
F	0.75		1	0.030		0.039
F1	1.15		1.5	0.045		0.067
F2	1.15		1.5	0.045		0.067
G	4.95		5.2	0.195		0.204
G1	2.4		2.7	0.094		0.106
H	10		10.4	0.393		0.409
L2		16			0.630	
L3	28.6		30.6	1.126		1.204
L4	9.8		10.6	.0385		0.417
L5	2.9		3.6	0.114		0.141
L6	15.9		16.4	0.626		0.645
L7	9		9.3	0.354		0.366
Ø	3		3.2	0.118		0.126



TO-252 (DPAK) MECHANICAL DATA

DIM.	mm			inch		
	MIN.	TYP.	MAX.	MIN.	TYP.	MAX.
A	2.20		2.40	0.087		0.094
A1	0.90		1.10	0.035		0.043
A2	0.03		0.23	0.001		0.009
B	0.64		0.90	0.025		0.035
B2	5.20		5.40	0.204		0.213
C	0.45		0.60	0.018		0.024
C2	0.48		0.60	0.019		0.024
D	6.00		6.20	0.236		0.244
E	6.40		6.60	0.252		0.260
G	4.40		4.60	0.173		0.181
H	9.35		10.10	0.368		0.398
L2		0.8			0.031	
L4	0.60		1.00	0.024		0.039
V2	0°		8°	0°		0°

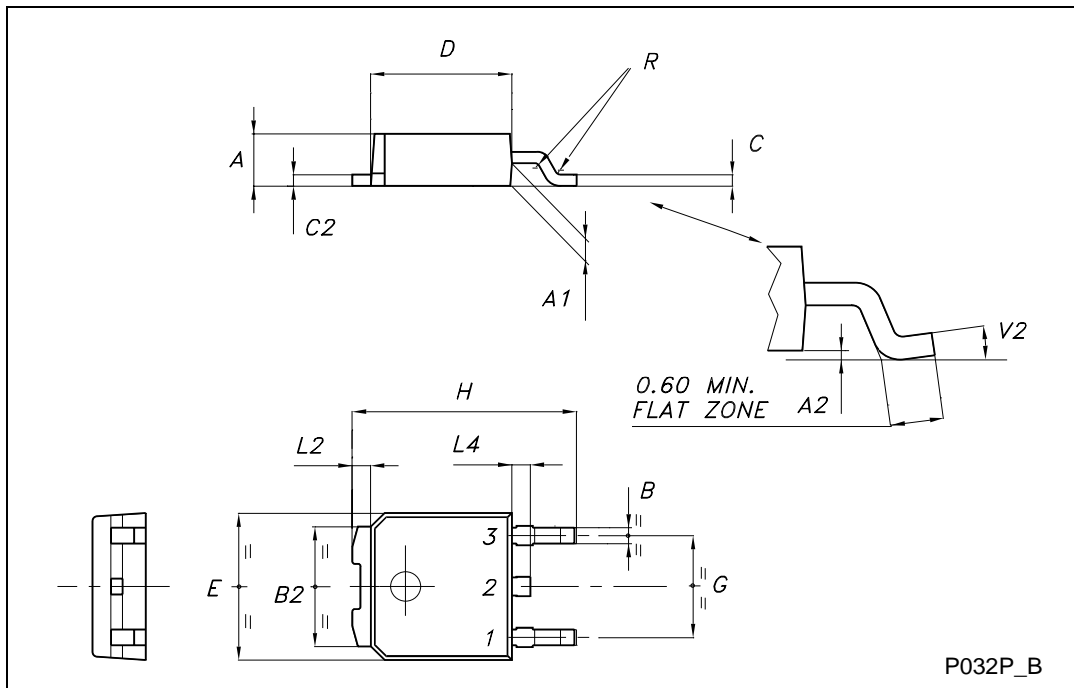

DPAK FOOTPRINT

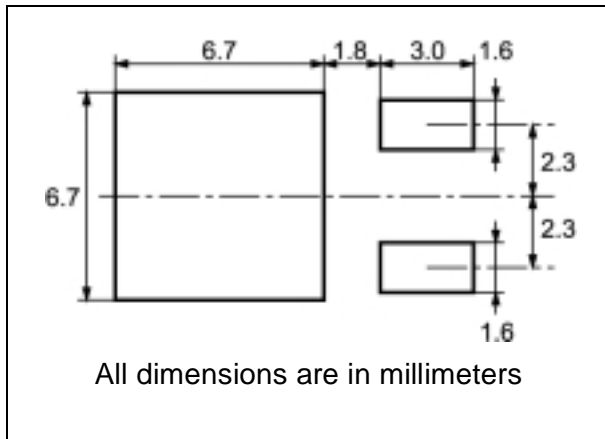

TUBE SHIPMENT (no suffix)*

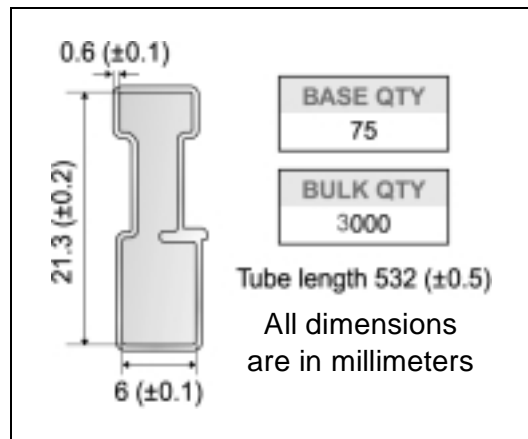

TAPE AND REEL SHIPMENT (suffix "T4")*

40 mm min. Access hole at slot location

Full radius

Tape slot in core for tape start 2.5mm min. width

G measured at hub

REEL MECHANICAL DATA

DIM.	mm		inch	
	MIN.	MAX.	MIN.	MAX.
A		330		12.992
B	1.5		0.059	
C	12.8	13.2	0.504	0.520
D	20.2		0.795	
G	16.4	18.4	0.645	0.724
N	50		1.968	
T		22.4		0.881

BASE QTY	BULK QTY
2500	2500

TAPE MECHANICAL DATA

DIM.	mm		inch	
	MIN.	MAX.	MIN.	MAX.
A0	6.8	7	0.267	0.275
B0	10.4	10.6	0.409	0.417
B1		12.1		0.476
D	1.5	1.6	0.059	0.063
D1	1.5		0.059	
E	1.65	1.85	0.065	0.073
F	7.4	7.6	0.291	0.299
K0	2.55	2.75	0.100	0.108
P0	3.9	4.1	0.153	0.161
P1	7.9	8.1	0.311	0.319
P2	1.9	2.1	0.075	0.082
R	40		1.574	
W	15.7	16.3	0.618	0.641

10 pitches cumulative tolerance on tape +/- 0.2 mm

User Direction of Feed

Center line of cavity

R min.

Bending radius

FEED DIRECTION

TRL

For machine net only including shaft and radii concentric around B0

* on sales type



Information furnished is believed to be accurate and reliable. However, STMicroelectronics assumes no responsibility for the consequences of use of such information nor for any infringement of patents or other rights of third parties which may result from its use. No license is granted by implication or otherwise under any patent or patent rights of STMicroelectronics. Specifications mentioned in this publication are subject to change without notice. This publication supersedes and replaces all information previously supplied. STMicroelectronics products are not authorized for use as critical components in life support devices or systems without express written approval of STMicroelectronics.

The ST logo is a registered trademark of STMicroelectronics
All other names are the property of their respective owners

© 2004 STMicroelectronics - All Rights Reserved
STMicroelectronics GROUP OF COMPANIES

Australia - Belgium - Brazil - Canada - China - Czech Republic - Finland - France - Germany - Hong Kong - India - Israel - Italy - Japan -
Malaysia - Malta - Morocco - Singapore - Spain - Sweden - Switzerland - United Kingdom - United States.
<http://www.st.com>