

2N7002K, 2V7002K

Small Signal MOSFET

60 V, 380 mA, Single, N-Channel, SOT-23

Features

- ESD Protected
- Low $R_{DS(on)}$
- Surface Mount Package
- 2V Prefix for Automotive and Other Applications Requiring Unique Site and Control Change Requirements; AEC-Q101 Qualified and PPAP Capable
- These Devices are Pb-Free, Halogen Free/BFR Free and are RoHS Compliant

Applications

- Low Side Load Switch
- Level Shift Circuits
- DC-DC Converter
- Portable Applications i.e. DSC, PDA, Cell Phone, etc.

MAXIMUM RATINGS ($T_J = 25^\circ\text{C}$ unless otherwise stated)

Rating	Symbol	Value	Unit
Drain-to-Source Voltage	V_{DS}	60	V
Gate-to-Source Voltage	V_{GS}	± 20	V
Drain Current (Note 1) Steady State 1 sq in Pad	I_D	$T_A = 25^\circ\text{C}$ 380	mA
		$T_A = 85^\circ\text{C}$ 270	
Drain Current (Note 2) Steady State Minimum Pad	I_D	$T_A = 25^\circ\text{C}$ 320	mA
		$T_A = 85^\circ\text{C}$ 230	
Power Dissipation Steady State 1 sq in Pad Steady State Minimum Pad	P_D	420	mW
		300	
Pulsed Drain Current ($t_p = 10 \mu\text{s}$)	I_{DM}	1.5	A
Operating Junction and Storage Temperature Range	T_J, T_{STG}	-55 to +150	$^\circ\text{C}$
Source Current (Body Diode)	I_S	300	mA
Lead Temperature for Soldering Purposes (1/8" from case for 10 s)	T_L	260	$^\circ\text{C}$
Gate-Source ESD Rating (HBM, Method 3015)	ESD	2000	V

Stresses exceeding Maximum Ratings may damage the device. Maximum Ratings are stress ratings only. Functional operation above the Recommended Operating Conditions is not implied. Extended exposure to stresses above the Recommended Operating Conditions may affect device reliability.

1. Surface-mounted on FR4 board using 1 sq in pad size with 1 oz Cu.
2. Surface-mounted on FR4 board using 0.08 sq in pad size with 1 oz Cu.



ON Semiconductor®

<http://onsemi.com>

$V_{(BR)DSS}$	$R_{DS(on)}$ MAX	I_D MAX
60 V	1.6 Ω @ 10 V	380 mA
	2.5 Ω @ 4.5 V	

SIMPLIFIED SCHEMATIC

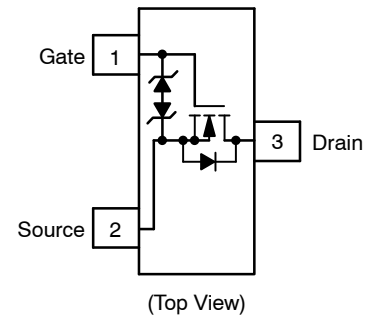

MARKING DIAGRAM & PIN ASSIGNMENT

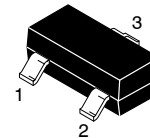

SOT-23
CASE 318
STYLE 21

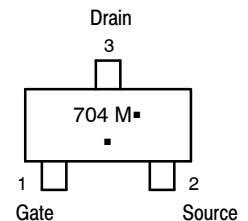

704 = Specific Device Code*
M = Date Code*
■ = Pb-Free Package

(Note: Microdot may be in either location)
*Specific Device Code, Date Code or overbar orientation and/or location may vary depending upon manufacturing location. This is a representation only and actual devices may not match this drawing exactly.

ORDERING INFORMATION

Device	Package	Shipping†
2N7002KT1G	SOT-23 (Pb-Free)	3000 / Tape & Reel
2V7002KT1G	SOT-23 (Pb-Free)	3000 / Tape & Reel

†For information on tape and reel specifications, including part orientation and tape sizes, please refer to our Tape and Reel Packaging Specifications Brochure, BRD8011/D.

2N7002K, 2V7002K

THERMAL CHARACTERISTICS

Characteristic	Symbol	Max	Unit
Junction-to-Ambient – Steady State (Note 3)	R _{θJA}	300	°C/W
Junction-to-Ambient – t ≤ 5 s (Note 3)		92	
Junction-to-Ambient – Steady State (Note 4)		417	
Junction-to-Ambient – t ≤ 5 s (Note 4)		154	

3. Surface-mounted on FR4 board using 1 sq in pad size with 1 oz Cu.

4. Surface-mounted on FR4 board using 0.08 sq in pad size with 1 oz Cu.

ELECTRICAL CHARACTERISTICS (T_J = 25°C unless otherwise specified)

Parameter	Symbol	Test Condition	Min	Typ	Max	Unit
-----------	--------	----------------	-----	-----	-----	------

OFF CHARACTERISTICS

Drain-to-Source Breakdown Voltage	V _{(BR)DSS}	V _{GS} = 0 V, I _D = 250 μA	60			V
Drain-to-Source Breakdown Voltage Temperature Coefficient	V _{(BR)DSS} /T _J			71		mV/°C
Zero Gate Voltage Drain Current	I _{DSS}	V _{GS} = 0 V, V _{DS} = 60 V	T _J = 25°C		1	μA
			T _J = 125°C		500	
		V _{GS} = 0 V, V _{DS} = 50 V	T _J = 25°C		100	nA
Gate-to-Source Leakage Current	I _{GSS}	V _{DS} = 0 V, V _{GS} = ±20 V			±10	μA
		V _{DS} = 0 V, V _{GS} = ±10 V			450	nA
		V _{DS} = 0 V, V _{GS} = ±5.0 V			150	nA

ON CHARACTERISTICS (Note 5)

Gate Threshold Voltage	V _{GS(TH)}	V _{GS} = V _{DS} , I _D = 250 μA	1.0		2.3	V
Negative Threshold Temperature Coefficient	V _{GS(TH)} /T _J			4.0		mV/°C
Drain-to-Source On Resistance	R _{DS(on)}	V _{GS} = 10 V, I _D = 500 mA		1.19	1.6	Ω
		V _{GS} = 4.5 V, I _D = 200 mA		1.33	2.5	
Forward Transconductance	g _{FS}	V _{DS} = 5 V, I _D = 200 mA		530		mS

CHARGES AND CAPACITANCES

Input Capacitance	C _{ISS}	V _{GS} = 0 V, f = 1 MHz, V _{DS} = 20 V		24.5		pF
Output Capacitance	C _{OSS}			4.2		
Reverse Transfer Capacitance	C _{RSS}			2.2		
Total Gate Charge	Q _{G(TOT)}	V _{GS} = 4.5 V, V _{DS} = 10 V; I _D = 200 mA		0.7		nC
Threshold Gate Charge	Q _{G(TH)}			0.1		
Gate-to-Source Charge	Q _{GS}			0.3		
Gate-to-Drain Charge	Q _{GD}			0.1		

SWITCHING CHARACTERISTICS, V_{GS} = V (Note 6)

Turn-On Delay Time	t _{d(ON)}	V _{GS} = 10 V, V _{DD} = 25 V, I _D = 500 mA, R _G = 25 Ω		12.2		ns
Rise Time	t _r			9.0		
Turn-Off Delay Time	t _{d(OFF)}			55.8		
Fall Time	t _f			29		

DRAIN-SOURCE DIODE CHARACTERISTICS

Forward Diode Voltage	V _{SD}	V _{GS} = 0 V, I _S = 200 mA	T _J = 25°C		0.8	1.2	V
			T _J = 85°C		0.7		

5. Pulse Test: pulse width ≤ 300 μs, duty cycle ≤ 2%

6. Switching characteristics are independent of operating junction temperatures

TYPICAL CHARACTERISTICS

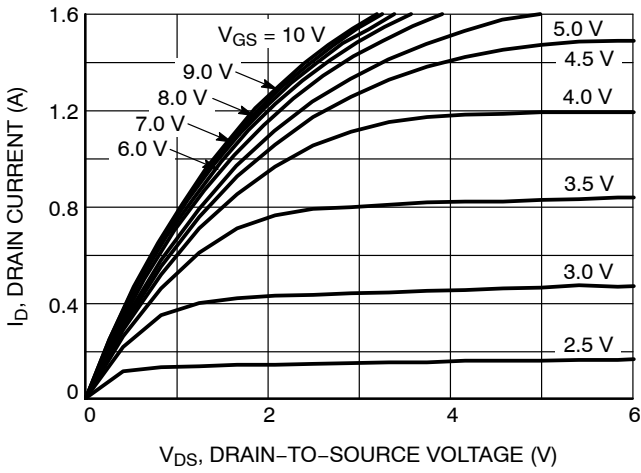

Figure 1. On-Region Characteristics

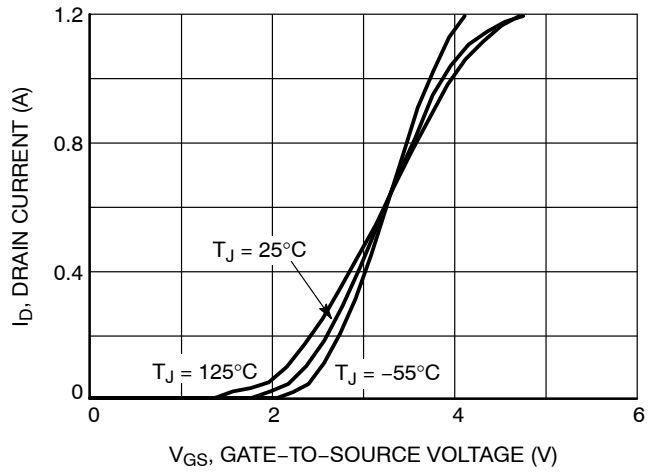

Figure 2. Transfer Characteristics

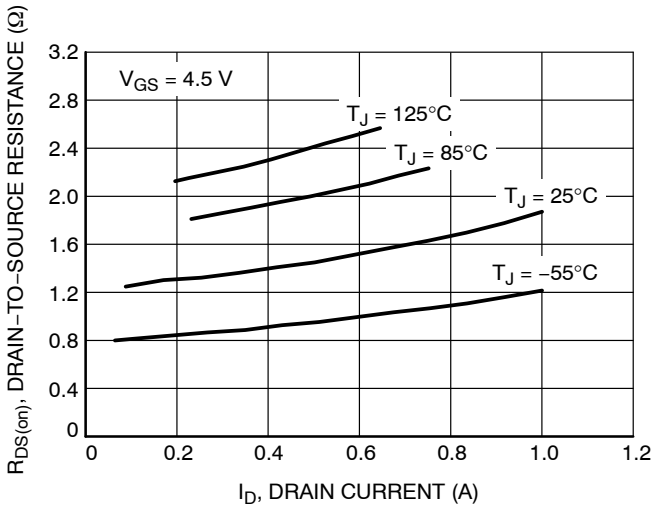

Figure 3. On-Resistance vs. Drain Current and Temperature

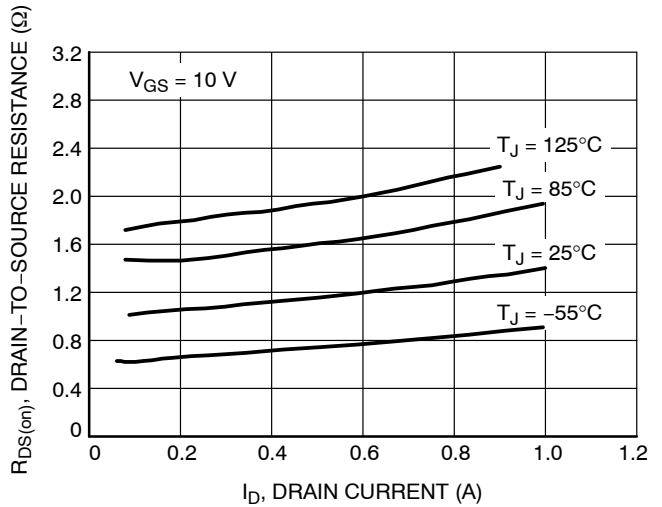

Figure 4. On-Resistance vs. Drain Current and Temperature

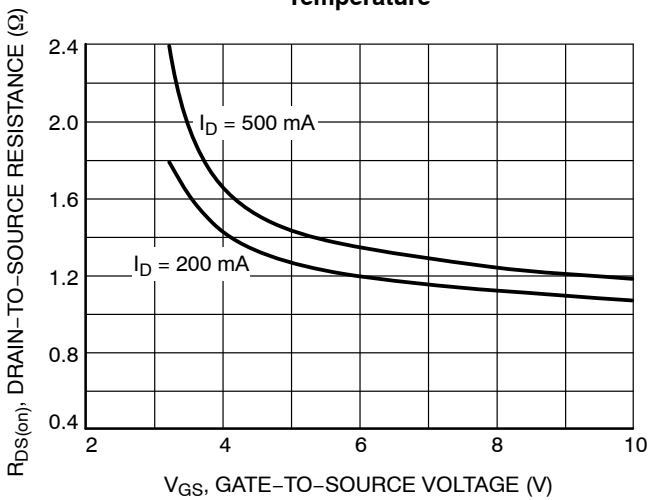

Figure 5. On-Resistance vs. Gate-to-Source Voltage

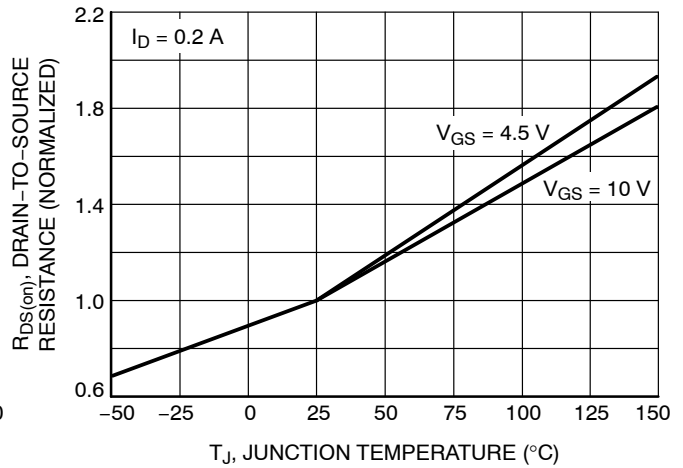

Figure 6. On-Resistance Variation with Temperature

2N7002K, 2V7002K

TYPICAL CHARACTERISTICS

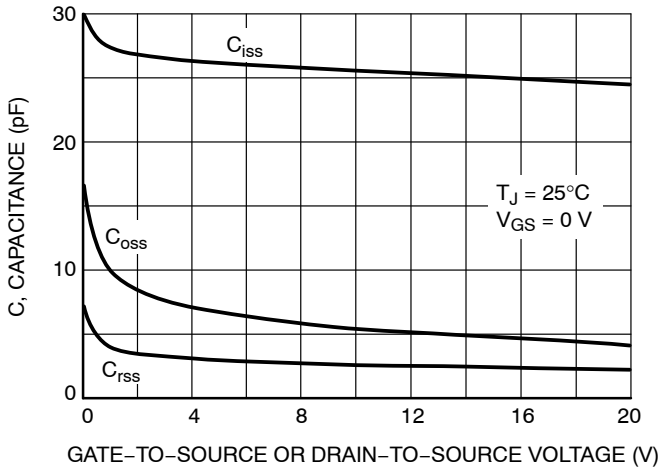

Figure 7. Capacitance Variation

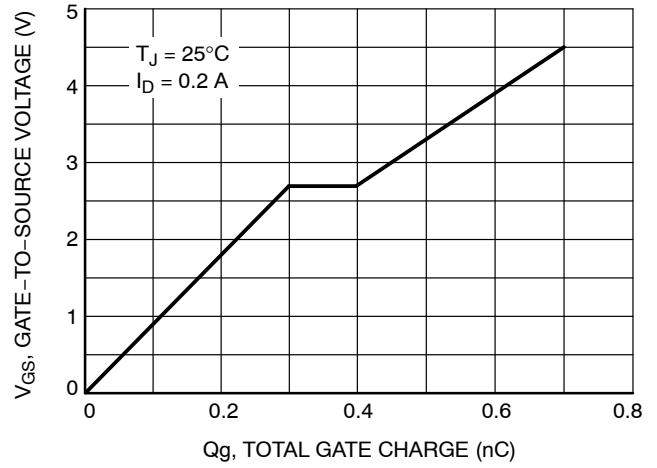

Figure 8. Gate-to-Source and Drain-to-Source Voltage vs. Total Charge

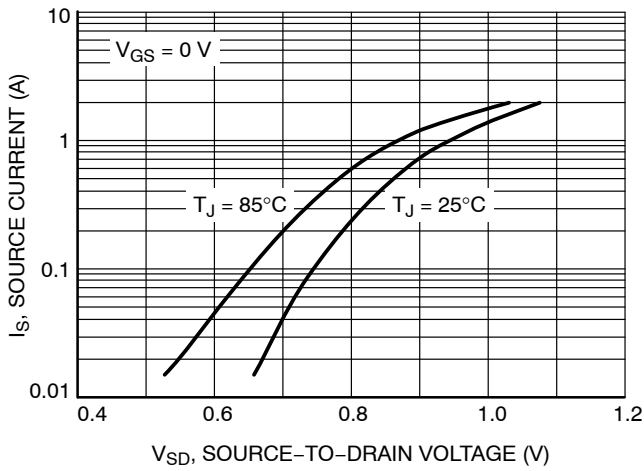

Figure 9. Diode Forward Voltage vs. Current

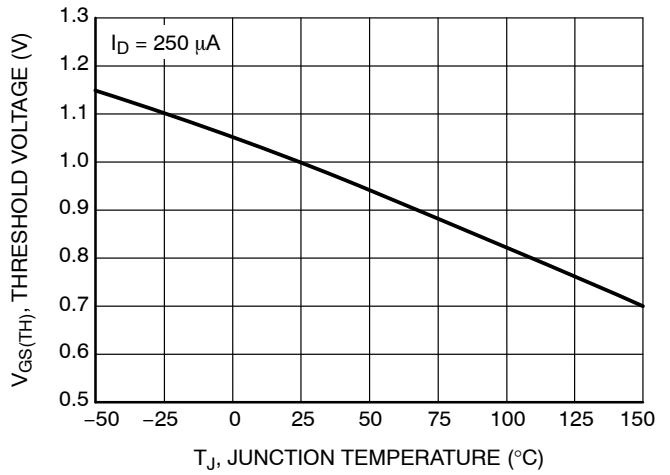

Figure 10. Threshold Voltage with Temperature

2N7002K, 2V7002K

TYPICAL CHARACTERISTICS

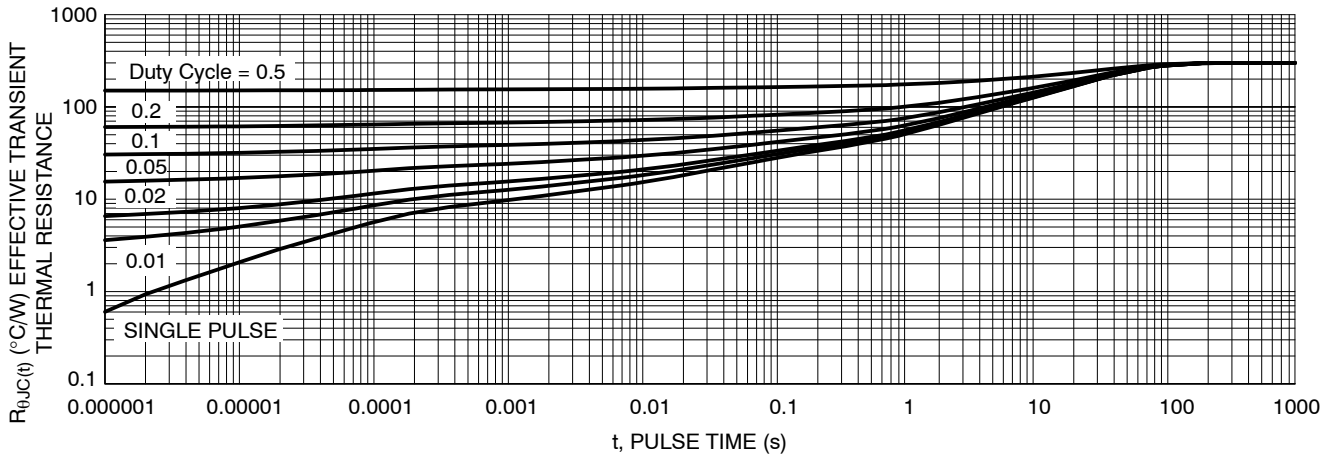

Figure 11. Thermal Response - 1 sq in pad

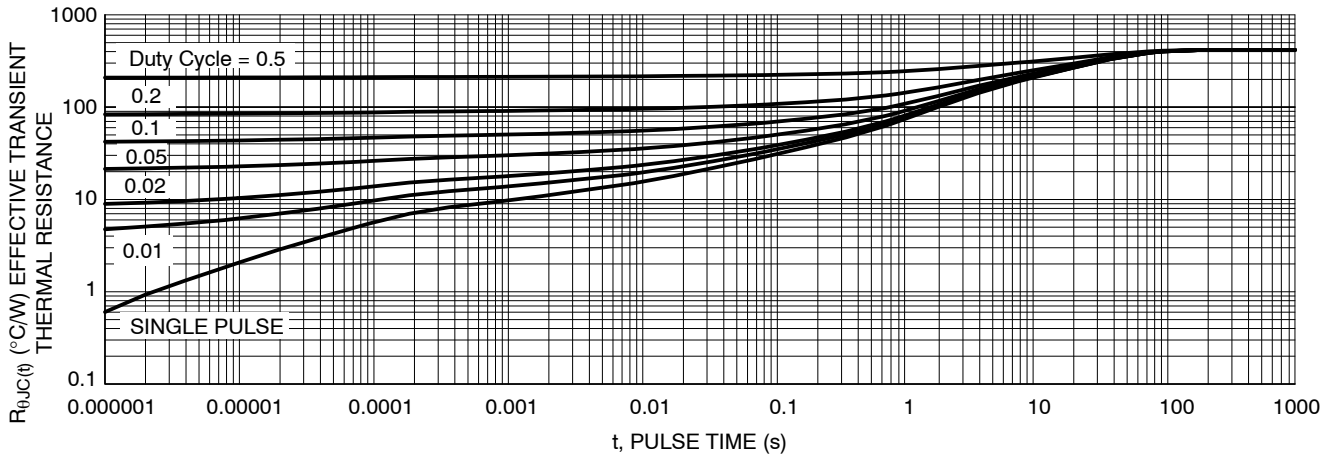
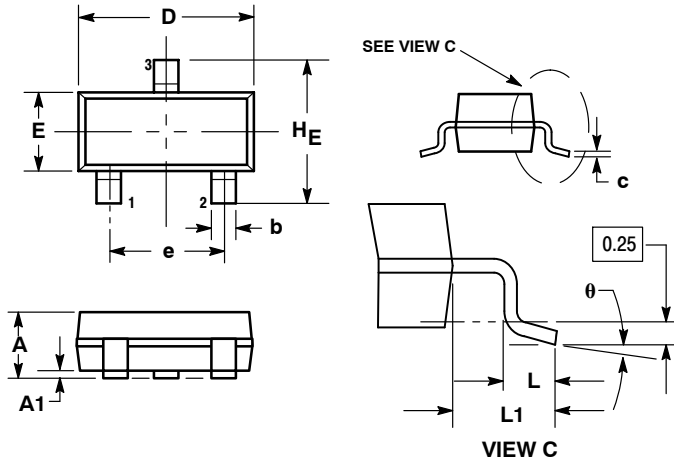

Figure 12. Thermal Response - minimum pad

2N7002K, 2V7002K

PACKAGE DIMENSIONS

SOT-23 (TO-236)
CASE 318-08
ISSUE AP



- NOTES:
1. DIMENSIONING AND TOLERANCING PER ANSI Y14.5M, 1982.
 2. CONTROLLING DIMENSION: INCH.
 3. MAXIMUM LEAD THICKNESS INCLUDES LEAD FINISH THICKNESS. MINIMUM LEAD THICKNESS IS THE MINIMUM THICKNESS OF BASE MATERIAL.
 4. DIMENSIONS D AND E DO NOT INCLUDE MOLD FLASH, PROTRUSIONS, OR GATE BURRS.

DIM	MILLIMETERS			INCHES		
	MIN	NOM	MAX	MIN	NOM	MAX
A	0.89	1.00	1.11	0.035	0.040	0.044
A1	0.01	0.06	0.10	0.001	0.002	0.004
b	0.37	0.44	0.50	0.015	0.018	0.020
c	0.09	0.13	0.18	0.003	0.005	0.007
D	2.80	2.90	3.04	0.110	0.114	0.120
E	1.20	1.30	1.40	0.047	0.051	0.055
e	1.78	1.90	2.04	0.070	0.075	0.081
L	0.10	0.20	0.30	0.004	0.008	0.012
L1	0.35	0.54	0.69	0.014	0.021	0.029
HE	2.10	2.40	2.64	0.083	0.094	0.104
θ	0°	---	10°	0°	---	10°

STYLE 21:
PIN 1. GATE
2. SOURCE
3. DRAIN

SOLDERING FOOTPRINT

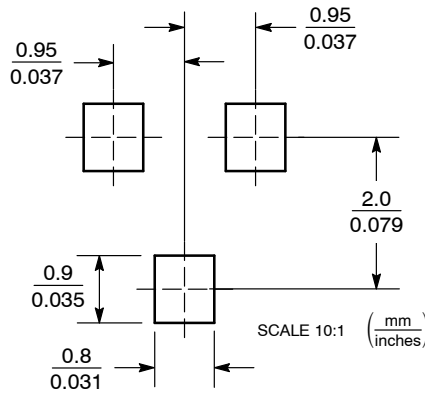

ON Semiconductor and are registered trademarks of Semiconductor Components Industries, LLC (SCILLC). SCILLC reserves the right to make changes without further notice to any products herein. SCILLC makes no warranty, representation or guarantee regarding the suitability of its products for any particular purpose, nor does SCILLC assume any liability arising out of the application or use of any product or circuit, and specifically disclaims any and all liability, including without limitation special, consequential or incidental damages. "Typical" parameters which may be provided in SCILLC data sheets and/or specifications can and do vary in different applications and actual performance may vary over time. All operating parameters, including "Typicals" must be validated for each customer application by customer's technical experts. SCILLC does not convey any license under its patent rights nor the rights of others. SCILLC products are not designed, intended, or authorized for use as components in systems intended for surgical implant into the body, or other applications intended to support or sustain life, or for any other application in which the failure of the SCILLC product could create a situation where personal injury or death may occur. Should Buyer purchase or use SCILLC products for any such unintended or unauthorized application, Buyer shall indemnify and hold SCILLC and its officers, employees, subsidiaries, affiliates, and distributors harmless against all claims, costs, damages, and expenses, and reasonable attorney fees arising out of, directly or indirectly, any claim of personal injury or death associated with such unintended or unauthorized use, even if such claim alleges that SCILLC was negligent regarding the design or manufacture of the part. SCILLC is an Equal Opportunity/Affirmative Action Employer. This literature is subject to all applicable copyright laws and is not for resale in any manner.

PUBLICATION ORDERING INFORMATION

LITERATURE FULFILLMENT:
Literature Distribution Center for ON Semiconductor
P.O. Box 5163, Denver, Colorado 80217 USA
Phone: 303-675-2175 or 800-344-3860 Toll Free USA/Canada
Fax: 303-675-2176 or 800-344-3867 Toll Free USA/Canada
Email: orderlit@onsemi.com

N. American Technical Support: 800-282-9855 Toll Free
USA/Canada
Europe, Middle East and Africa Technical Support:
Phone: 421 33 790 2910
Japan Customer Focus Center
Phone: 81-3-5817-1050

ON Semiconductor Website: www.onsemi.com

Order Literature: <http://www.onsemi.com/orderlit>

For additional information, please contact your local Sales Representative