

# BUK754R3-75C; BUK7E4R3-75C

N-channel TrenchMOS standard level FET

Rev. 01 — 10 August 2006

Product data sheet

## 1. Product profile

### 1.1 General description

N-channel enhancement mode power Field-Effect Transistor (FET) in a plastic package, using Philips Ultra High-Performance (UHP) automotive TrenchMOS technology.

### 1.2 Features

- TrenchMOS technology
- 175 °C rated
- Q101 compliant
- Standard level compatible

### 1.3 Applications

- Automotive systems
- Motors, lamps and solenoids
- General purpose power switching
- 12 V, 24 V and 42 V loads

### 1.4 Quick reference data

- $E_{DS(AL)S} \leq 630$  mJ
- $I_D \leq 100$  A
- $R_{DS(on)} = 3.7$  m $\Omega$  (typ)
- $P_{tot} \leq 333$  W

## 2. Pinning information

Table 1. Pinning

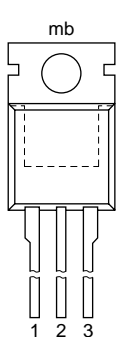
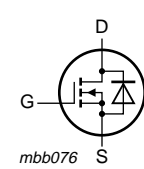
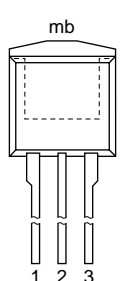
Pin	Description	Simplified outline	Symbol
1	gate (G)		
2	drain (D)		
3	source (S)		
mb	mounting base; connected to drain		<i>mbb076</i>
		SOT78 (TO-220AB)	SOT226 (I2PAK)

PHILIPS

### 3. Ordering information

**Table 2. Ordering information**

Type number	Package		Version
	Name	Description	
BUK754R3-75C	SC-46	plastic single-ended package; heatsink mounted; 1 mounting hole; 3-lead TO-220AB	SOT78
BUK7E4R3-75C	I2PAK	plastic single-ended package (I2PAK); low-profile 3-lead TO-220AB	SOT226

### 4. Limiting values

**Table 3. Limiting values**

In accordance with the Absolute Maximum Rating System (IEC 60134).

Symbol	Parameter	Conditions	Min	Max	Unit	
$V_{DS}$	drain-source voltage		-	75	V	
$V_{DGR}$	drain-gate voltage (DC)	$R_{GS} = 20 \text{ k}\Omega$	-	75	V	
$V_{GS}$	gate-source voltage		-	$\pm 20$	V	
$I_D$	drain current	$V_{GS} = 10 \text{ V}$ ; see <a href="#">Figure 2</a> and <a href="#">3</a>	[1]			
		limited by power dissipation at $T_{mb} = 25 \text{ }^\circ\text{C}$	[2]	-	192	A
		limited by package at $T_{mb} = 25 \text{ }^\circ\text{C}$	[3]	-	100	A
		limited by package at $T_{mb} = 100 \text{ }^\circ\text{C}$	[3]	-	100	A
$I_{DM}$	peak drain current	$T_{mb} = 25 \text{ }^\circ\text{C}$ ; pulsed; $t_p \leq 10 \text{ }\mu\text{s}$ ; see <a href="#">Figure 3</a>	-	769	A	
$P_{tot}$	total power dissipation	$T_{mb} = 25 \text{ }^\circ\text{C}$ ; see <a href="#">Figure 1</a>	-	333	W	
$T_{stg}$	storage temperature		-55	+175	$^\circ\text{C}$	
$T_j$	junction temperature		-55	+175	$^\circ\text{C}$	

#### Source-drain diode

$I_{DR}$	reverse drain current	$T_{mb} = 25 \text{ }^\circ\text{C}$	[1]			
		limited by power dissipation	[2]	-	192	A
		limited by package	[3]	-	100	A
$I_{DRM}$	peak reverse drain current	$T_{mb} = 25 \text{ }^\circ\text{C}$ ; pulsed; $t_p \leq 10 \text{ }\mu\text{s}$	-	769	A	

#### Avalanche ruggedness

$E_{DS(AL)S}$	non-repetitive drain-source avalanche energy	unclamped inductive load; $I_D = 100 \text{ A}$ ; $V_{DS} \leq 75 \text{ V}$ ; $R_{GS} = 50 \text{ }\Omega$ ; $V_{GS} = 10 \text{ V}$ ; starting at $T_j = 25 \text{ }^\circ\text{C}$	-	630	mJ
$E_{DS(AL)R}$	repetitive drain-source avalanche energy		[4]	-	mJ

- [1] Refer to document 9397 750 12572 for further information.
- [2] Current is limited by chip power dissipation rating.
- [3] Continuous current is limited by package.
- [4] Conditions:
- Maximum value not quoted. Repetitive rating defined in [Figure 16](#).
  - Single-pulse avalanche rating limited by  $T_{j(max)}$  of  $175 \text{ }^\circ\text{C}$ .
  - Repetitive avalanche rating limited by an average junction temperature of  $170 \text{ }^\circ\text{C}$ .
  - Refer to application note AN10273 for further information.

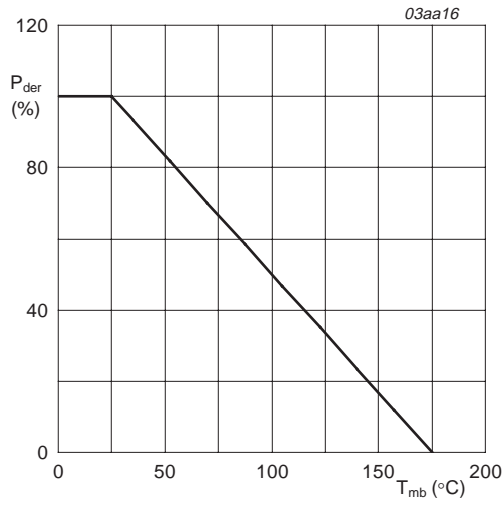

$$P_{der} = \frac{P_{tot}}{P_{tot(25^{\circ}C)}} \times 100\%$$

**Fig 1. Normalized total power dissipation as a function of mounting base temperature**

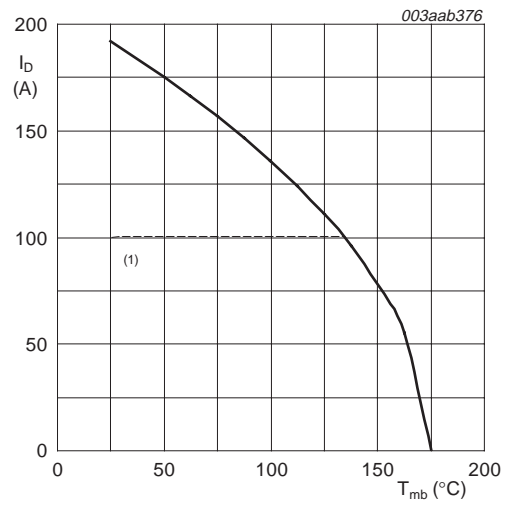

V<sub>GS</sub> ≥ 10 V

(1) Capped at 100 A due to package.

**Fig 2. Continuous drain current as a function of mounting base temperature**

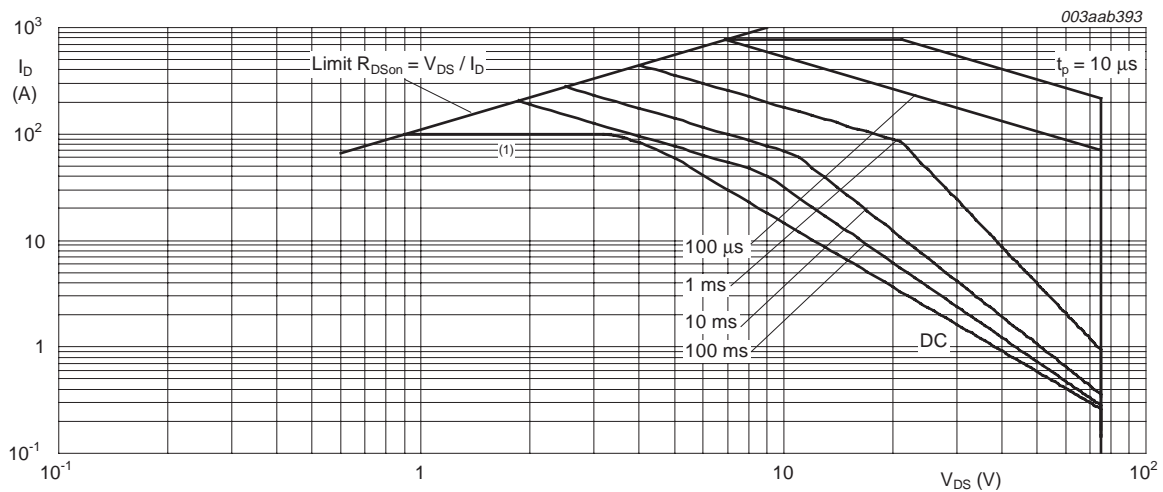

T<sub>mb</sub> = 25 °C; I<sub>DM</sub> is single pulse.

(1) Capped at 100 A due to package.

**Fig 3. Safe operating area; continuous and peak drain currents as a function of drain-source voltage**

**5. Thermal characteristics**

**Table 4. Thermal characteristics**

Symbol	Parameter	Conditions	Min	Typ	Max	Unit
$R_{th(j-mb)}$	thermal resistance from junction to mounting base		-	-	0.45	K/W
$R_{th(j-a)}$	thermal resistance from junction to ambient					
	SOT78	vertical in free air	-	60	-	K/W
	SOT226	vertical in free air	-	50	-	K/W

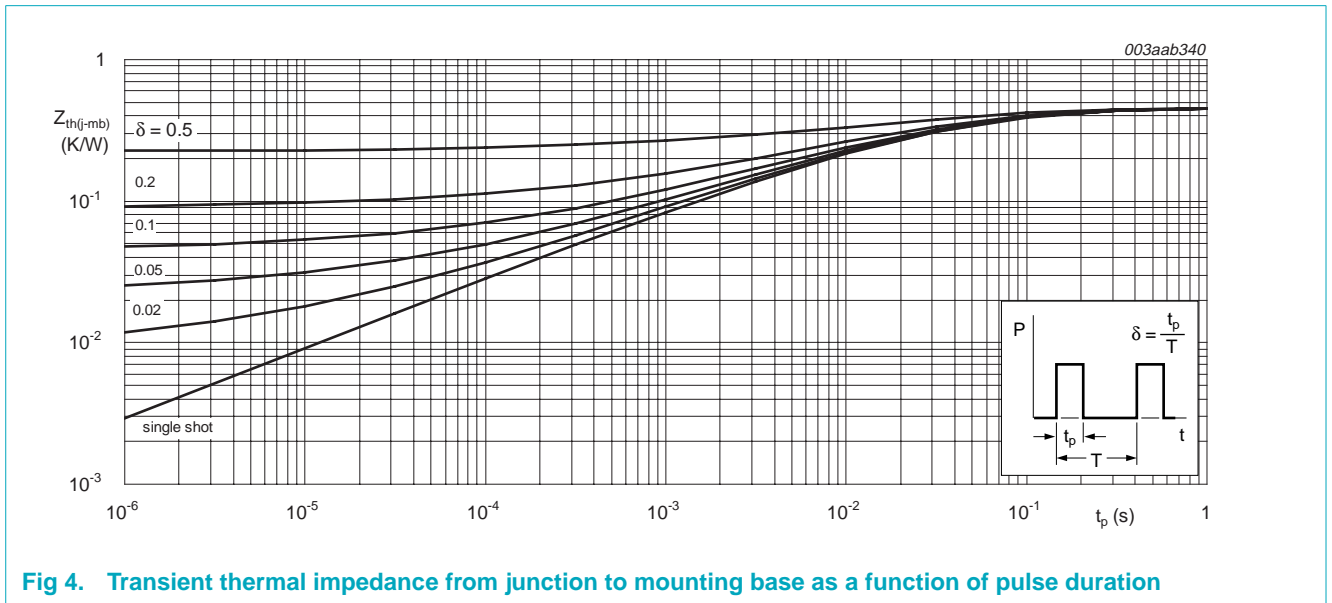

**Fig 4. Transient thermal impedance from junction to mounting base as a function of pulse duration**

## 6. Characteristics

**Table 5. Characteristics**

$T_j = 25\text{ °C}$  unless otherwise specified.

Symbol	Parameter	Conditions	Min	Typ	Max	Unit
<b>Static characteristics</b>						
$V_{(BR)DSS}$	drain-source breakdown voltage	$I_D = 250\ \mu\text{A}$ ; $V_{GS} = 0\ \text{V}$ $T_j = 25\text{ °C}$	75	-	-	V
			70	-	-	V
$V_{GS(th)}$	gate-source threshold voltage	$I_D = 1\ \text{mA}$ ; $V_{DS} = V_{GS}$ ; see <a href="#">Figure 9</a> and <a href="#">10</a>	2	3	4	V
			1	-	-	V
			-	-	4.4	V
			$T_j = -55\text{ °C}$			
$I_{DSS}$	drain leakage current	$V_{DS} = 75\ \text{V}$ ; $V_{GS} = 0\ \text{V}$ $T_j = 25\text{ °C}$	-	0.02	1	$\mu\text{A}$
			-	-	500	$\mu\text{A}$
$I_{GSS}$	gate leakage current	$V_{GS} = \pm 20\ \text{V}$ ; $V_{DS} = 0\ \text{V}$	-	2	100	nA
$R_{DS(on)}$	drain-source on-state resistance	$V_{GS} = 10\ \text{V}$ ; $I_D = 25\ \text{A}$ ; see <a href="#">Figure 6</a> and <a href="#">8</a>	-	3.7	4.3	m $\Omega$
			-	-	9	m $\Omega$
<b>Dynamic characteristics</b>						
$Q_{G(tot)}$	total gate charge	$I_D = 25\ \text{A}$ ; $V_{DD} = 60\ \text{V}$ ; $V_{GS} = 10\ \text{V}$ ; see <a href="#">Figure 14</a>	-	142	-	nC
$Q_{GS}$	gate-source charge		-	36	-	nC
$Q_{GD}$	gate-drain charge		-	67	-	nC
$V_{GS(pl)}$	gate-source plateau voltage		-	5	-	V
$C_{iss}$	input capacitance	$V_{GS} = 0\ \text{V}$ ; $V_{DS} = 25\ \text{V}$ ; $f = 1\ \text{MHz}$ ; see <a href="#">Figure 12</a>	-	8744	11659	pF
$C_{oss}$	output capacitance		-	923	1108	pF
$C_{rss}$	reverse transfer capacitance		-	579	793	pF
$t_{d(on)}$	turn-on delay time	$V_{DS} = 30\ \text{V}$ ; $R_L = 1.2\ \Omega$ ; $V_{GS} = 10\ \text{V}$ ; $R_G = 10\ \Omega$	-	61	-	ns
$t_r$	rise time		-	100	-	ns
$t_{d(off)}$	turn-off delay time		-	194	-	ns
$t_f$	fall time		-	90	-	ns
$L_D$	internal drain inductance	from drain lead 6 mm from package to center of die	-	4.5	-	nH
		from contact screw on mounting base to center of die	-	3.5	-	nH
		from upper edge of drain mounting base to center of die SOT226	-	2.5	-	nH
$L_S$	internal source inductance	from source lead to source bonding pad	-	7.5	-	nH

**Table 5. Characteristics ...continued**  
 $T_j = 25\text{ }^\circ\text{C}$  unless otherwise specified.

Symbol	Parameter	Conditions	Min	Typ	Max	Unit
<b>Source-drain diode</b>						
$V_{SD}$	source-drain voltage	$I_S = 25\text{ A}$ ; $V_{GS} = 0\text{ V}$ ; see <a href="#">Figure 15</a>	-	0.85	1.2	V
$t_{rr}$	reverse recovery time	$I_S = 20\text{ A}$ ; $dI_S/dt = -100\text{ A}/\mu\text{s}$ ;	-	83	-	ns
$Q_r$	recovered charge	$V_{GS} = 0\text{ V}$ ; $V_R = 25\text{ V}$	-	155	-	nC

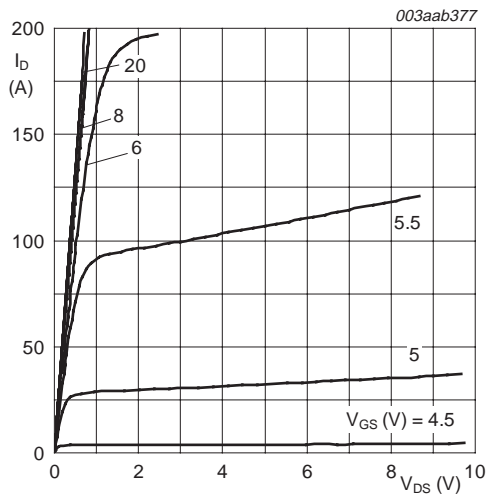

$T_j = 25\text{ }^\circ\text{C}$

**Fig 5. Output characteristics: drain current as a function of drain-source voltage; typical values**

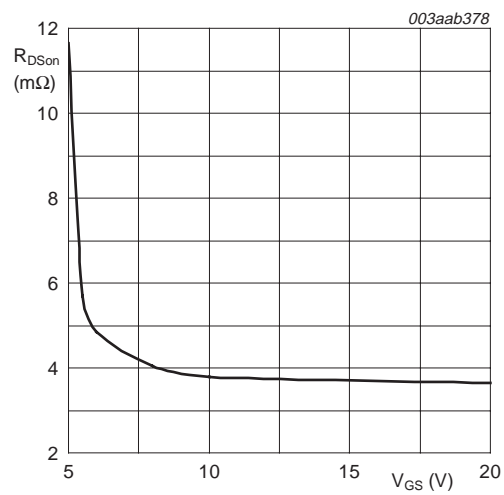

$T_j = 25\text{ }^\circ\text{C}$ ;  $I_D = 25\text{ A}$

**Fig 6. Drain source on-state resistance as a function of gate-source voltage; typical values**

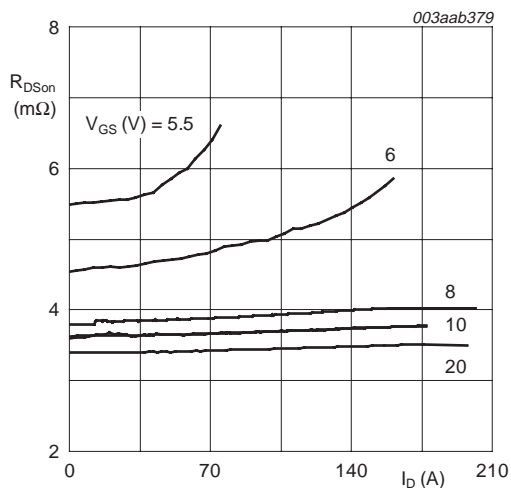

$I_D = 1\text{ mA}$ ;  $V_{DS} = V_{GS}$

**Fig 7. Drain-source on-state resistance as a function of drain current; typical values**

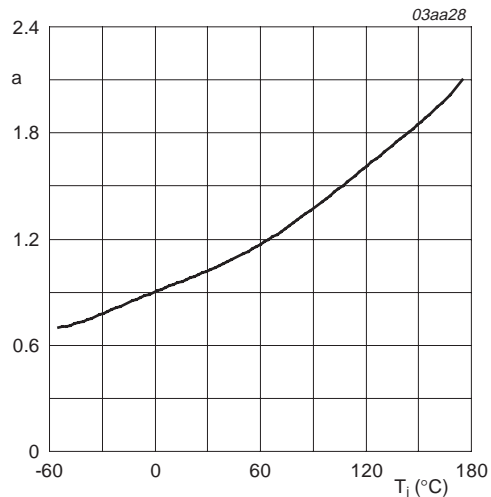

$$a = \frac{R_{DS(on)}}{R_{DS(on)(25^\circ\text{C})}}$$

**Fig 8. Normalized drain-source on-state resistance factor as a function of junction temperature**

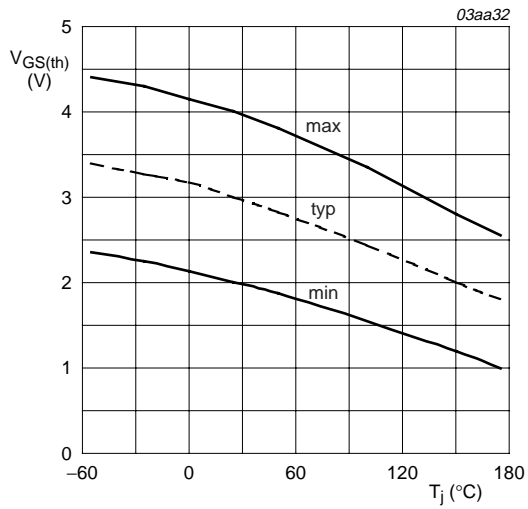

$I_D = 1 \text{ mA}; V_{DS} = V_{GS}$

**Fig 9. Gate-source threshold voltage as a function of junction temperature**

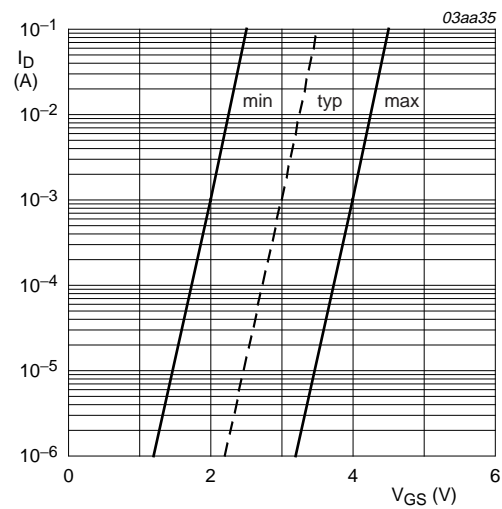

$T_j = 25 \text{ }^\circ\text{C}; V_{DS} = V_{GS}$

**Fig 10. Sub-threshold drain current as a function of gate-source voltage**

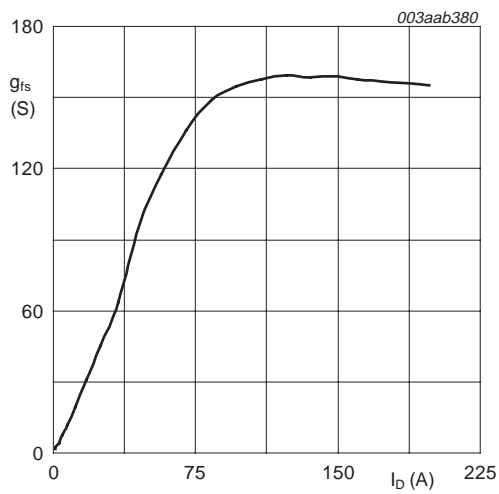

$T_j = 25 \text{ }^\circ\text{C}; V_{DS} = 25 \text{ V}$

**Fig 11. Forward transconductance as a function of drain current; typical values**

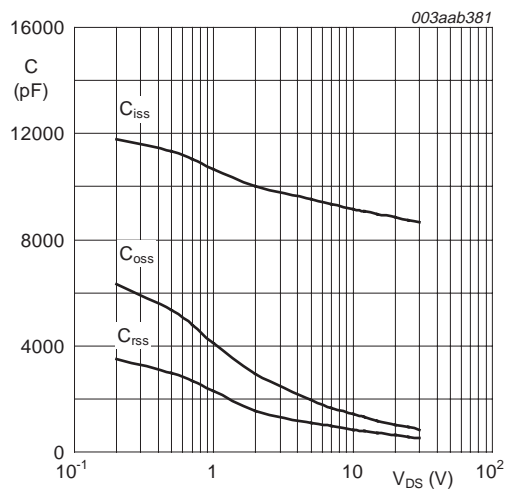

$V_{GS} = 0 \text{ V}; f = 1 \text{ MHz}$

**Fig 12. Input, output and reverse transfer capacitances as a function of drain-source voltage; typical values**

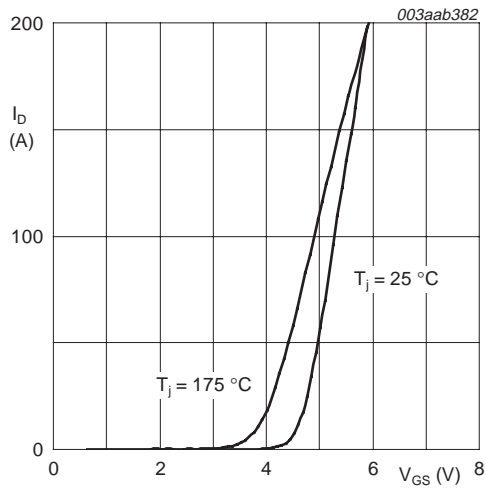

$V_{DS} = 25\text{ V}$

**Fig 13. Transfer characteristics: drain current as a function of gate-source voltage; typical values**

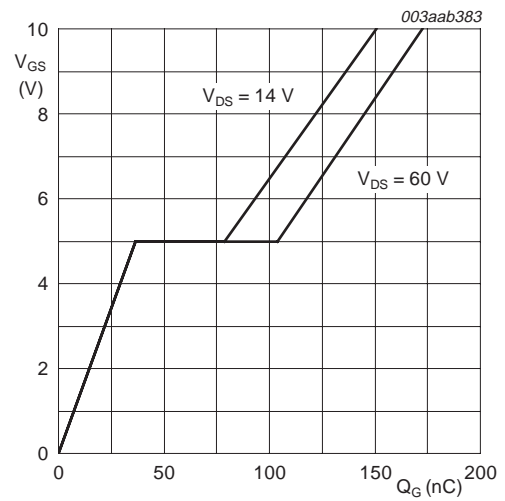

$T_j = 25\text{ °C}; I_D = 25\text{ A}$

**Fig 14. Gate-source voltage as a function of gate charge; typical values**

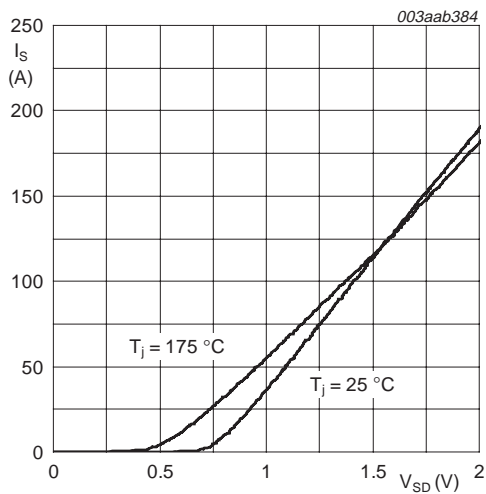

$V_{GS} = 0\text{ V}$

**Fig 15. Source current as a function of source-drain voltage; typical values**

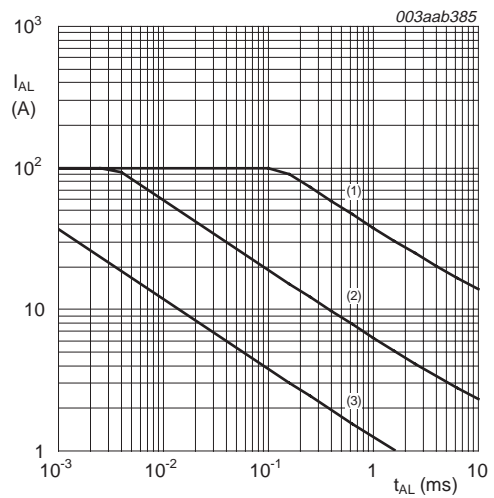

See [Table note 4](#) of [Table 3 "Limiting values"](#).

- (1) Single-pulse;  $T_j = 25\text{ °C}$ .
- (2) Single-pulse;  $T_j = 150\text{ °C}$ .
- (3) Repetitive.

**Fig 16. Single-pulse and repetitive avalanche rating; avalanche current as a function of avalanche time**



**7. Package outline**

Plastic single-ended package; heatsink mounted; 1 mounting hole; 3-lead TO-220AB

SOT78

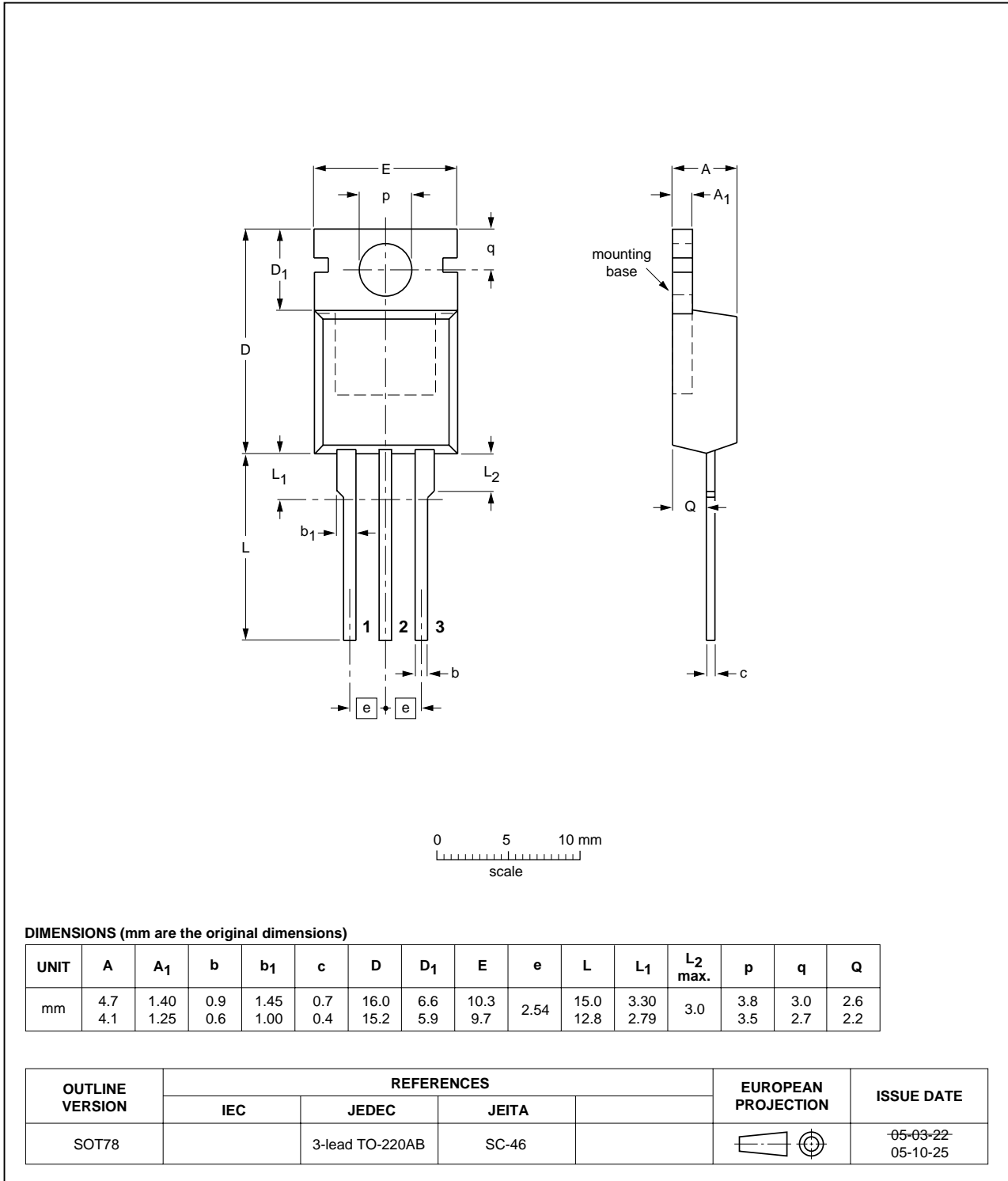

Fig 17. Package outline SOT78 (TO-220AB)

Plastic single-ended package (I2PAK); low-profile 3-lead TO-220AB

SOT226

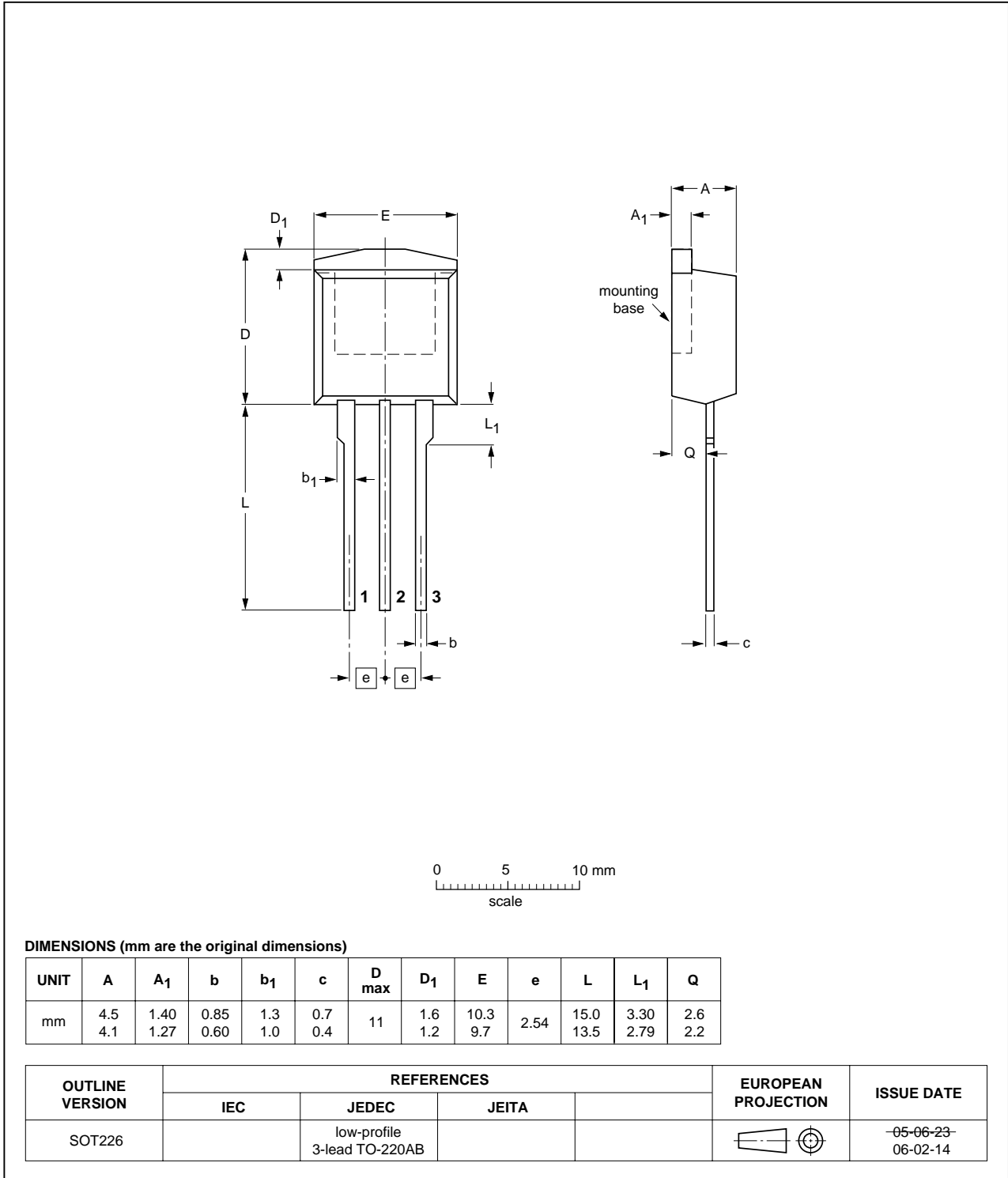

Fig 18. Package outline SOT226 (I2PAK)

## 8. Revision history

**Table 6. Revision history**

Document ID	Release date	Data sheet status	Change notice	Supersedes
BUK75_7E4R3-75C_1	20060810	Product data sheet	-	-

## 9. Legal information

### 9.1 Data sheet status

Document status <sup>[1][2]</sup>	Product status <sup>[3]</sup>	Definition
Objective [short] data sheet	Development	This document contains data from the objective specification for product development.
Preliminary [short] data sheet	Qualification	This document contains data from the preliminary specification.
Product [short] data sheet	Production	This document contains the product specification.

[1] Please consult the most recently issued document before initiating or completing a design.

[2] The term 'short data sheet' is explained in section "Definitions".

[3] The product status of device(s) described in this document may have changed since this document was published and may differ in case of multiple devices. The latest product status information is available on the Internet at URL <http://www.semiconductors.philips.com>.

### 9.2 Definitions

**Draft** — The document is a draft version only. The content is still under internal review and subject to formal approval, which may result in modifications or additions. Philips Semiconductors does not give any representations or warranties as to the accuracy or completeness of information included herein and shall have no liability for the consequences of use of such information.

**Short data sheet** — A short data sheet is an extract from a full data sheet with the same product type number(s) and title. A short data sheet is intended for quick reference only and should not be relied upon to contain detailed and full information. For detailed and full information see the relevant full data sheet, which is available on request via the local Philips Semiconductors sales office. In case of any inconsistency or conflict with the short data sheet, the full data sheet shall prevail.

### 9.3 Disclaimers

**General** — Information in this document is believed to be accurate and reliable. However, Philips Semiconductors does not give any representations or warranties, expressed or implied, as to the accuracy or completeness of such information and shall have no liability for the consequences of use of such information.

**Right to make changes** — Philips Semiconductors reserves the right to make changes to information published in this document, including without limitation specifications and product descriptions, at any time and without notice. This document supersedes and replaces all information supplied prior to the publication hereof.

**Suitability for use** — Philips Semiconductors products are not designed, authorized or warranted to be suitable for use in medical, military, aircraft, space or life support equipment, nor in applications where failure or malfunction of a Philips Semiconductors product can reasonably be expected

to result in personal injury, death or severe property or environmental damage. Philips Semiconductors accepts no liability for inclusion and/or use of Philips Semiconductors products in such equipment or applications and therefore such inclusion and/or use is at the customer's own risk.

**Applications** — Applications that are described herein for any of these products are for illustrative purposes only. Philips Semiconductors makes no representation or warranty that such applications will be suitable for the specified use without further testing or modification.

**Limiting values** — Stress above one or more limiting values (as defined in the Absolute Maximum Ratings System of IEC 60134) may cause permanent damage to the device. Limiting values are stress ratings only and operation of the device at these or any other conditions above those given in the Characteristics sections of this document is not implied. Exposure to limiting values for extended periods may affect device reliability.

**Terms and conditions of sale** — Philips Semiconductors products are sold subject to the general terms and conditions of commercial sale, as published at <http://www.semiconductors.philips.com/profile/terms>, including those pertaining to warranty, intellectual property rights infringement and limitation of liability, unless explicitly otherwise agreed to in writing by Philips Semiconductors. In case of any inconsistency or conflict between information in this document and such terms and conditions, the latter will prevail.

**No offer to sell or license** — Nothing in this document may be interpreted or construed as an offer to sell products that is open for acceptance or the grant, conveyance or implication of any license under any copyrights, patents or other industrial or intellectual property rights.

### 9.4 Trademarks

Notice: All referenced brands, product names, service names and trademarks are the property of their respective owners.

**TrenchMOS** — is a trademark of Koninklijke Philips Electronics N.V.

## 10. Contact information

For additional information, please visit: <http://www.semiconductors.philips.com>

For sales office addresses, send an email to: [sales.addresses@www.semiconductors.philips.com](mailto:sales.addresses@www.semiconductors.philips.com)

## 11. Contents

---

<b>1</b>	<b>Product profile</b> .....	<b>1</b>
1.1	General description .....	1
1.2	Features .....	1
1.3	Applications .....	1
1.4	Quick reference data .....	1
<b>2</b>	<b>Pinning information</b> .....	<b>1</b>
<b>3</b>	<b>Ordering information</b> .....	<b>2</b>
<b>4</b>	<b>Limiting values</b> .....	<b>2</b>
<b>5</b>	<b>Thermal characteristics</b> .....	<b>4</b>
<b>6</b>	<b>Characteristics</b> .....	<b>5</b>
<b>7</b>	<b>Package outline</b> .....	<b>9</b>
<b>8</b>	<b>Revision history</b> .....	<b>11</b>
<b>9</b>	<b>Legal information</b> .....	<b>12</b>
9.1	Data sheet status .....	12
9.2	Definitions .....	12
9.3	Disclaimers .....	12
9.4	Trademarks .....	12
<b>10</b>	<b>Contact information</b> .....	<b>12</b>
<b>11</b>	<b>Contents</b> .....	<b>13</b>



---

Please be aware that important notices concerning this document and the product(s) described herein, have been included in section 'Legal information'.

---

© Koninklijke Philips Electronics N.V. 2006. All rights reserved.

For more information, please visit: <http://www.semiconductors.philips.com>.

For sales office addresses, email to: [sales.addresses@www.semiconductors.philips.com](mailto:sales.addresses@www.semiconductors.philips.com).

Date of release: 10 August 2006

Document identifier: BUK75\_7E4R3-75C\_1