

## Power MOSFET

PRODUCT SUMMARY		
$V_{DS}$ (V)	- 50	
$R_{DS(on)}$ ( $\Omega$ )	$V_{GS} = -10$ V	0.28
$Q_g$ (Max.) (nC)	26	
$Q_{gs}$ (nC)	6.2	
$Q_{gd}$ (nC)	8.6	
Configuration	Single	

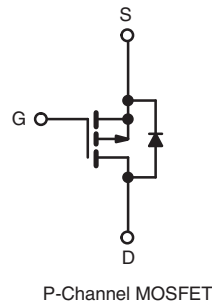
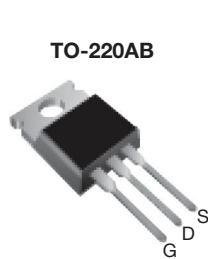

### FEATURES

- P-Channel Versatility
- Compact Plastic Package
- Fast Switching
- Low Drive Current
- Ease of Paralleling
- Excellent Temperature Stability
- Compliant to RoHS Directive 2002/95/EC



Available  
**RoHS\***  
COMPLIANT

### DESCRIPTION

The Power MOSFET technology is the key to Vishay's advanced line of Power MOSFET transistors. The efficient geometry and unique processing of the Power MOSFET design achieve very low on-state resistance combined with high transconductance and extreme device ruggedness.

The P-channel Power MOSFET's are designed for application which require the convenience of reverse polarity operation. They retain all of the features of the more common N-channel Power MOSFET's such as voltage control, very fast switching, ease of paralleling, and excellent temperature stability.

P-channel Power MOSFETs are intended for use in power stages where complementary symmetry with N-channel devices offers circuit simplification. They are also very useful in drive stages because of the circuit versatility offered by the reverse polarity connection. Applications include motor control, audio amplifiers, switched mode converters, control circuits and pulse amplifiers.

ORDERING INFORMATION	
Package	TO-220AB
Lead (Pb)-free	IRF9Z20PbF SiHF9Z20-E3
SnPb	IRF9Z20 SiHF9Z20



ABSOLUTE MAXIMUM RATINGS ( $T_C = 25^\circ\text{C}$ , unless otherwise noted)					
PARAMETER		SYMBOL	LIMIT	UNIT	
Drain-Source Voltage		$V_{DS}$	- 50	V	
Gate-Source Voltage		$V_{GS}$	$\pm 20$		
Continuous Drain Current	$V_{GS}$ at - 10 V	$I_D$	$T_C = 25^\circ\text{C}$	- 9.7	A
			$T_C = 100^\circ\text{C}$	- 6.1	
Pulsed Drain Current <sup>a</sup>		$I_{DM}$	- 39		
Linear Derating Factor			0.32	W/ $^\circ\text{C}$	
Inductive Current, Clamped	$L = 100 \mu\text{H}$	$I_{LM}$	- 39	A	
Unclamped Inductive Current (Avalanche Current)		$I_L$	- 2.2	A	
Maximum Power Dissipation	$T_C = 25^\circ\text{C}$	$P_D$	40	W	
Operating Junction and Storage Temperature Range		$T_J, T_{stg}$	- 55 to + 150	$^\circ\text{C}$	
Soldering Recommendations (Peak Temperature)	for 10 s		300 $^\circ\text{C}$		

#### Notes

- Repetitive rating; pulse width limited by maximum junction temperature (see fig. 14).
- $V_{DD} = -25$  V, starting  $T_J = 25^\circ\text{C}$ ,  $L = 100 \mu\text{H}$ ,  $R_g = 25 \Omega$
- 0.063" (1.6 mm) from case.

\* Pb containing terminations are not RoHS compliant, exemptions may apply

THERMAL RESISTANCE RATINGS				
PARAMETER	SYMBOL	TYP.	MAX.	UNIT
Maximum Junction-to-Ambient	$R_{thJA}$	-	80	°C/W
Case-to-Sink, Flat, Greased Surface	$R_{thCS}$	1.0	-	
Maximum Junction-to-Case (Drain)	$R_{thJC}$	-	3.1	

SPECIFICATIONS ( $T_J = 25\text{ }^\circ\text{C}$ , unless otherwise noted)						
PARAMETER	SYMBOL	TEST CONDITIONS	MIN.	TYP.	MAX.	UNIT
<b>Static</b>						
Drain-Source Breakdown Voltage	$V_{DS}$	$V_{GS} = 0\text{ V}$ , $I_D = -250\text{ }\mu\text{A}$	- 50	-	-	V
Gate-Source Threshold Voltage	$V_{GS(th)}$	$V_{DS} = V_{GS}$ , $I_D = -250\text{ }\mu\text{A}$	- 2.0	-	- 4.0	V
Gate-Source Leakage	$I_{GSS}$	$V_{GS} = \pm 20\text{ V}$	-	-	$\pm 500$	nA
Zero Gate Voltage Drain Current	$I_{DSS}$	$V_{DS} = \text{max. rating}$ , $V_{GS} = 0\text{ V}$	-	-	- 250	$\mu\text{A}$
		$V_{DS} = \text{max. rating} \times 0.8$ , $V_{GS} = 0\text{ V}$ , $T_J = 125\text{ }^\circ\text{C}$	-	-	- 1000	
Drain-Source On-State Resistance	$R_{DS(on)}$	$V_{GS} = -10\text{ V}$   $I_D = -5.6\text{ A}^b$	-	0.20	0.28	$\Omega$
Forward Transconductance	$g_{fs}$	$V_{DS} = 2 \times V_{GS}$ , $I_{DS} = -5.6\text{ A}^b$	2.3	3.5	-	S
<b>Dynamic</b>						
Input Capacitance	$C_{iss}$	$V_{GS} = 0\text{ V}$ , $V_{DS} = -25\text{ V}$ , $f = 1.0\text{ MHz}$ , see fig. 9	-	480	-	pF
Output Capacitance	$C_{oss}$		-	320	-	
Reverse Transfer Capacitance	$C_{rss}$		-	58	-	
Total Gate Charge	$Q_g$	$V_{GS} = -10\text{ V}$   $I_D = -9.7\text{ A}$ , $V_{DS} = -0.8\text{ max. rating}$ , see fig. 17	-	17	26	nC
Gate-Source Charge	$Q_{gs}$		-	4.1	6.2	
Gate-Drain Charge	$Q_{gd}$		-	5.7	8.6	
Turn-On Delay Time	$t_{d(on)}$	$V_{DD} = -25\text{ V}$ , $I_D = -9.7\text{ A}$ , $R_g = 18\text{ }\Omega$ , $R_D = 2.4\text{ }\Omega$ , see fig. 16 (MOSFET switching times are essentially independent of operating temperature)	-	8.2	12	ns
Rise Time	$t_r$		-	57	86	
Turn-Off Delay Time	$t_{d(off)}$		-	12	18	
Fall Time	$t_f$		-	25	38	
Internal Drain Inductance	$L_D$	Between lead, 6 mm (0.25") from package and center of die contact 	-	4.5	-	nH
Internal Source Inductance	$L_S$		-	7.5	-	
<b>Drain-Source Body Diode Characteristics</b>						
Continuous Source-Drain Diode Current	$I_S$	MOSFET symbol showing the integral reverse p - n junction diode 	-	-	- 9.7	A
Pulsed Diode Forward Current <sup>a</sup>	$I_{SM}$		-	-	- 39	
Body Diode Voltage	$V_{SD}$	$T_J = 25\text{ }^\circ\text{C}$ , $I_S = -9.7\text{ A}$ , $V_{GS} = 0\text{ V}^b$	-	-	- 6.3	V
Body Diode Reverse Recovery Time	$t_{rr}$	$T_J = 25\text{ }^\circ\text{C}$ , $I_F = -9.7\text{ A}$ , $dI/dt = 100\text{ A}/\mu\text{s}^b$	56	110	280	ns
Body Diode Reverse Recovery Charge	$Q_{rr}$		0.17	0.34	0.85	$\mu\text{C}$
Forward Turn-On Time	$t_{on}$	Intrinsic turn-on time is negligible (turn-on is dominated by $L_S$ and $L_D$ )				

**Notes**

- a. Repetitive rating; pulse width limited by maximum junction temperature (see fig. 14).
- b. Pulse width  $\leq 300\text{ }\mu\text{s}$ ; duty cycle  $\leq 2\%$ .

## TYPICAL CHARACTERISTICS (25 °C, unless otherwise noted)

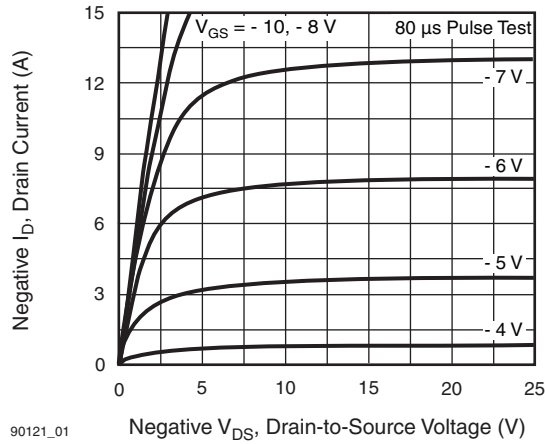

Fig. 1 - Typical Output Characteristics

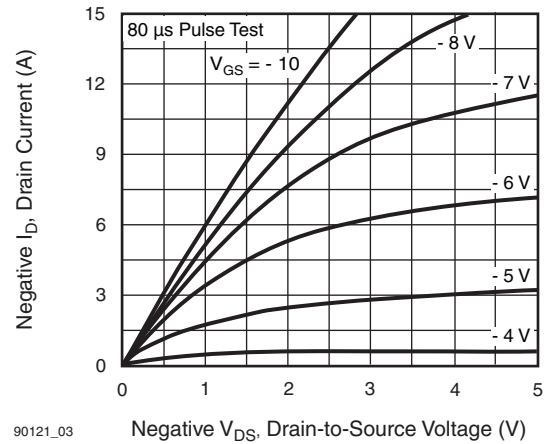

Fig. 3 - Typical Saturation Characteristics

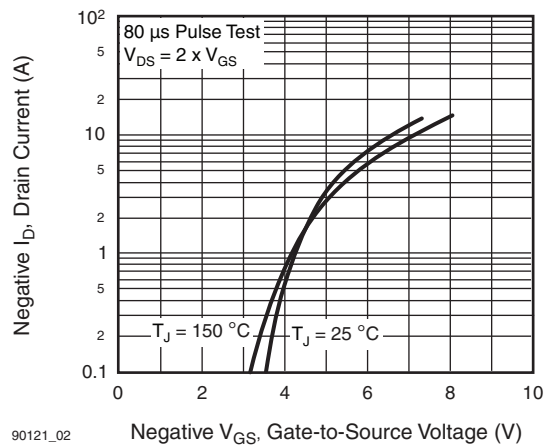

Fig. 2 - Typical Transfer Characteristics

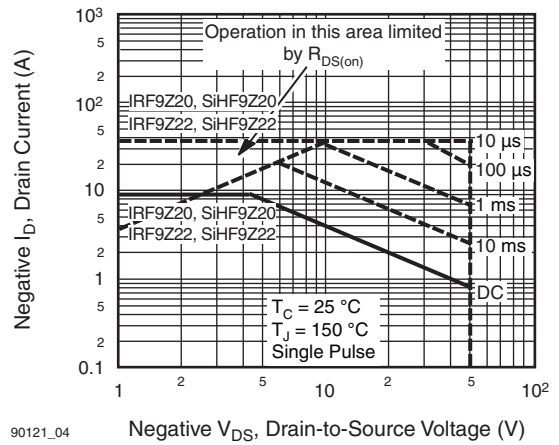
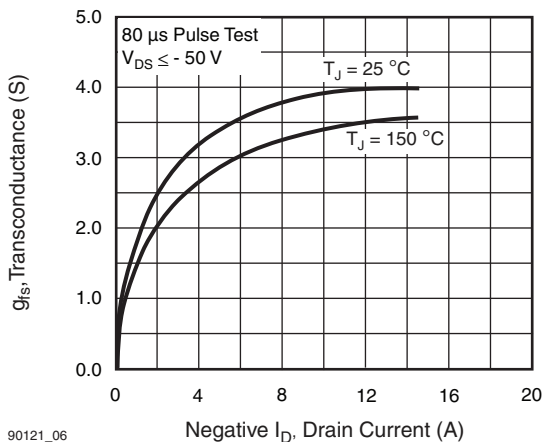
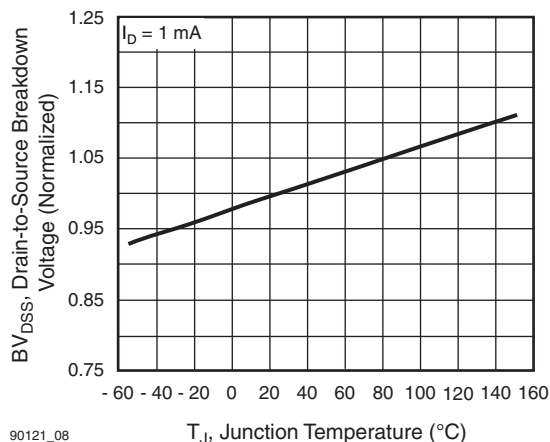

Fig. 4 - Maximum Safe Operating Area



90121\_06

**Fig. 5 - Typical Transconductance vs. Drain Current**



90121\_08

**Fig. 7 - Breakdown Voltage vs. Temperature**

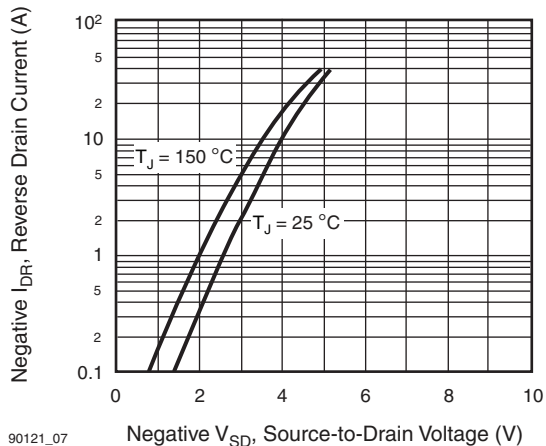

90121\_07

**Fig. 6 - Typical Source-Drain Diode Forward Voltage**

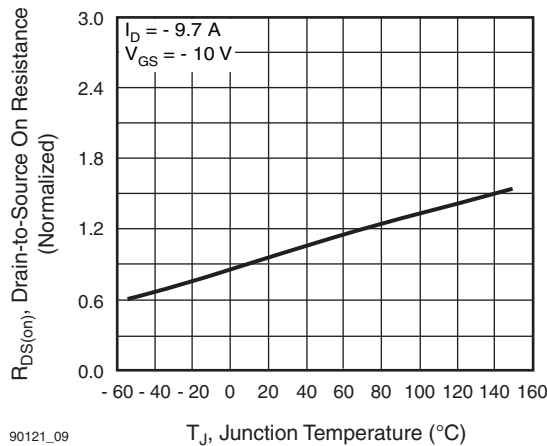

90121\_09

**Fig. 8 - Normalized On-Resistance vs. Temperature**

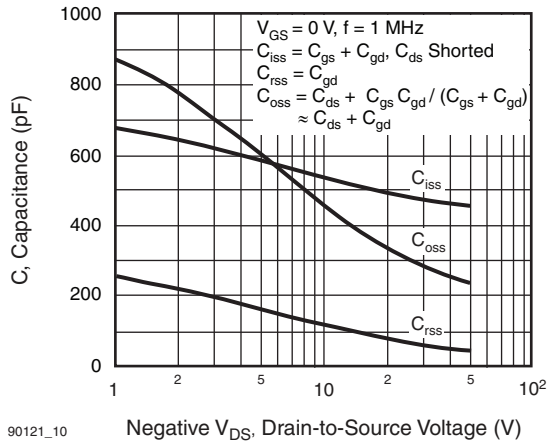

**Fig. 9 - Typical Capacitance vs. Drain-to-Source Voltage**

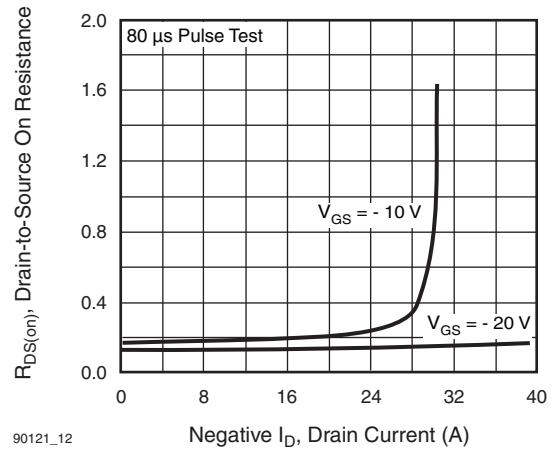

**Fig. 11 - Typical On-Resistance vs. Drain Current**

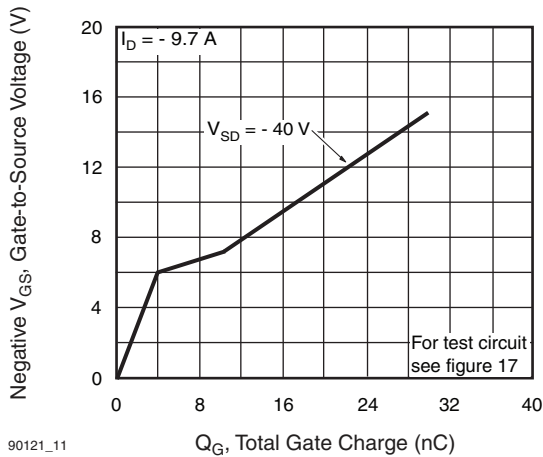

**Fig. 10 - Typical Gate Charge vs. Gate-to-Source Voltage**

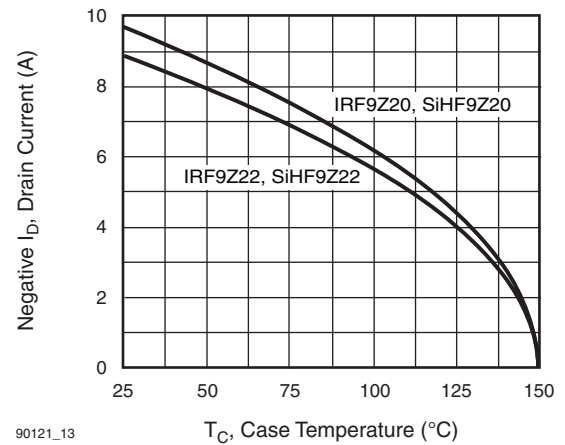

**Fig. 12 - Maximum Drain Current vs. Case Temperature**

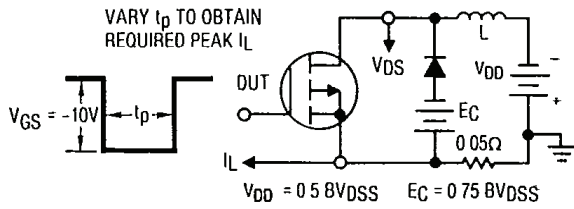

Fig. 13a - Unclamped Inductive Test Circuit

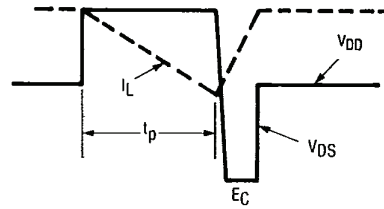
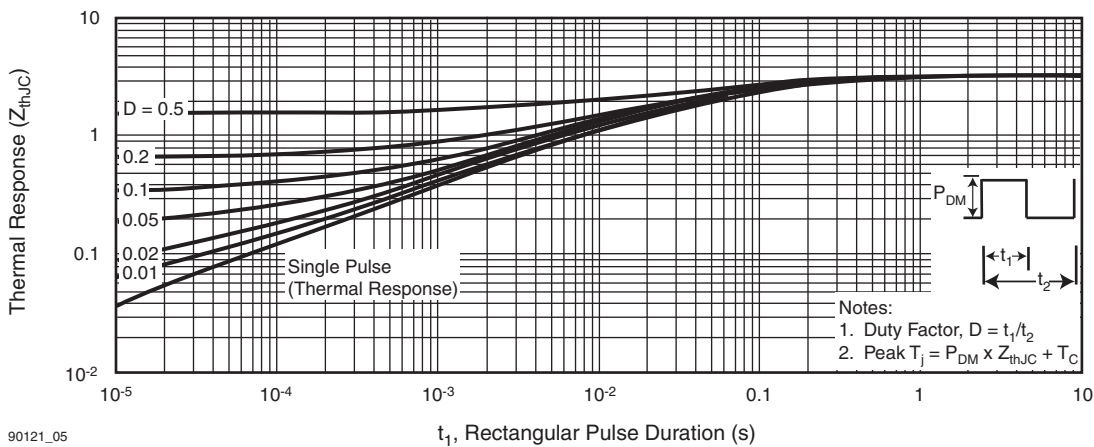

Fig. 13b - Unclamped Inductive Load Test Waveforms



90121\_05

Fig. 14 - Maximum Effective Transient Thermal Impedance, Junction-to-Case vs. Pulse Duration

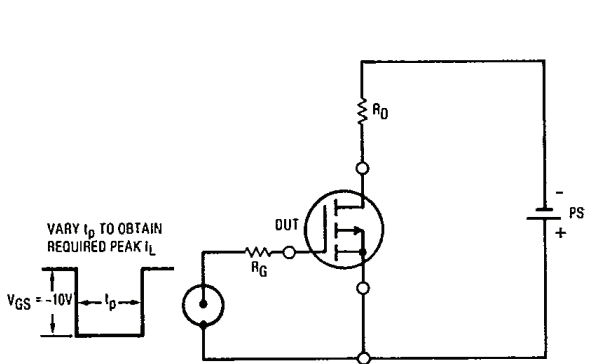

Fig. 15 - Switching Time Test Circuit

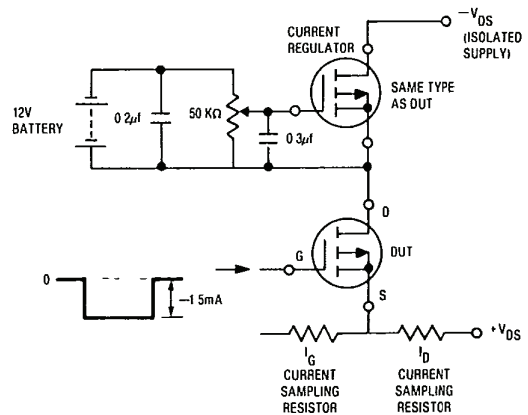
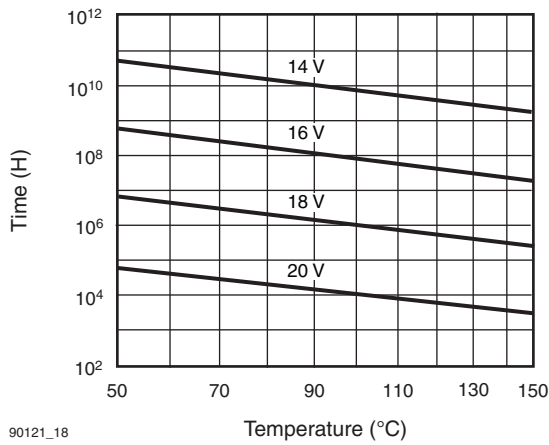
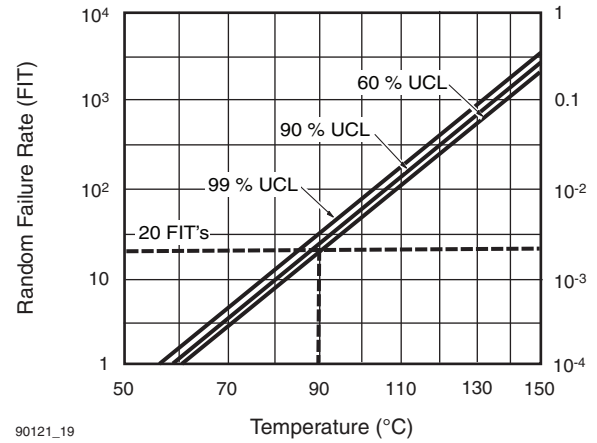

Fig. 16 - Gate Charge Test Circuit



90121\_18

Fig. 17 - Typical Time to Accumulated 1 % Gate Failure



90121\_19

Fig. 18 - Typical High Temperature Reverse Bias (HTRB) Failure Rate

Vishay Siliconix maintains worldwide manufacturing capability. Products may be manufactured at one of several qualified locations. Reliability data for Silicon Technology and Package Reliability represent a composite of all qualified locations. For related documents such as package/tape drawings, part marking, and reliability data, see [www.vishay.com/ppg?90121](http://www.vishay.com/ppg?90121).



## Disclaimer

ALL PRODUCT, PRODUCT SPECIFICATIONS AND DATA ARE SUBJECT TO CHANGE WITHOUT NOTICE TO IMPROVE RELIABILITY, FUNCTION OR DESIGN OR OTHERWISE.

Vishay Intertechnology, Inc., its affiliates, agents, and employees, and all persons acting on its or their behalf (collectively, "Vishay"), disclaim any and all liability for any errors, inaccuracies or incompleteness contained in any datasheet or in any other disclosure relating to any product.

Vishay makes no warranty, representation or guarantee regarding the suitability of the products for any particular purpose or the continuing production of any product. To the maximum extent permitted by applicable law, Vishay disclaims (i) any and all liability arising out of the application or use of any product, (ii) any and all liability, including without limitation special, consequential or incidental damages, and (iii) any and all implied warranties, including warranties of fitness for particular purpose, non-infringement and merchantability.

Statements regarding the suitability of products for certain types of applications are based on Vishay's knowledge of typical requirements that are often placed on Vishay products in generic applications. Such statements are not binding statements about the suitability of products for a particular application. It is the customer's responsibility to validate that a particular product with the properties described in the product specification is suitable for use in a particular application. Parameters provided in datasheets and/or specifications may vary in different applications and performance may vary over time. All operating parameters, including typical parameters, must be validated for each customer application by the customer's technical experts. Product specifications do not expand or otherwise modify Vishay's terms and conditions of purchase, including but not limited to the warranty expressed therein.

Except as expressly indicated in writing, Vishay products are not designed for use in medical, life-saving, or life-sustaining applications or for any other application in which the failure of the Vishay product could result in personal injury or death. Customers using or selling Vishay products not expressly indicated for use in such applications do so at their own risk and agree to fully indemnify and hold Vishay and its distributors harmless from and against any and all claims, liabilities, expenses and damages arising or resulting in connection with such use or sale, including attorneys fees, even if such claim alleges that Vishay or its distributor was negligent regarding the design or manufacture of the part. Please contact authorized Vishay personnel to obtain written terms and conditions regarding products designed for such applications.

No license, express or implied, by estoppel or otherwise, to any intellectual property rights is granted by this document or by any conduct of Vishay. Product names and markings noted herein may be trademarks of their respective owners.

## Material Category Policy

**Vishay Intertechnology, Inc. hereby certifies that all its products that are identified as RoHS-Compliant fulfill the definitions and restrictions defined under Directive 2011/65/EU of The European Parliament and of the Council of June 8, 2011 on the restriction of the use of certain hazardous substances in electrical and electronic equipment (EEE) - recast, unless otherwise specified as non-compliant.**

**Please note that some Vishay documentation may still make reference to RoHS Directive 2002/95/EC. We confirm that all the products identified as being compliant to Directive 2002/95/EC conform to Directive 2011/65/EU.**