

FDS3672

N-Channel PowerTrench® MOSFET 100V, 7.5A, 22mΩ

Features

- $r_{DS(ON)} = 19m\Omega$ (Typ.), $V_{GS} = 10V$, $I_D = 7.5A$
- $Q_g(tot) = 28nC$ (Typ.), $V_{GS} = 10V$
- Low Miller Charge
- Low Q_{RR} Body Diode
- Optimized efficiency at high frequencies
- UIS Capability (Single Pulse and Repetitive Pulse)

Applications

- DC/DC converters and Off-Line UPS
- Distributed Power Architectures and VRMs
- Primary Switch for 24V and 48V Systems
- High Voltage Synchronous Rectifier

Formerly developmental type 82763

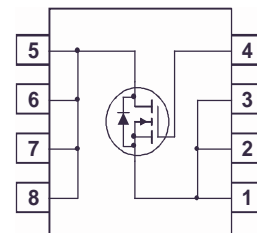
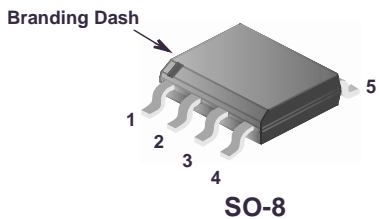

MOSFET Maximum Ratings $T_A = 25^\circ C$ unless otherwise noted

Symbol	Parameter	Ratings	Units
V_{DSS}	Drain to Source Voltage	100	V
V_{GS}	Gate to Source Voltage	± 20	V
I_D	Drain Current		
	Continuous ($T_A = 25^\circ C$, $V_{GS} = 10V$, $R_{\theta JA} = 50^\circ C/W$)	7.5	A
	Continuous ($T_A = 100^\circ C$, $V_{GS} = 10V$, $R_{\theta JA} = 50^\circ C/W$)	4.8	A
	Pulsed	Figure 4	A
E_{AS}	Single Pulse Avalanche Energy (Note 1)	416	mJ
P_D	Power dissipation	2.5	W
	Derate above $25^\circ C$	20	mW/ $^\circ C$
T_J, T_{STG}	Operating and Storage Temperature	-55 to 150	$^\circ C$

Thermal Characteristics

$R_{\theta JA}$	Thermal Resistance, Junction to Ambient at 10 seconds (Note 3)	50	$^\circ C/W$
$R_{\theta JA}$	Thermal Resistance, Junction to Ambient at 1000 seconds (Note 3)	85	$^\circ C/W$
$R_{\theta JC}$	Thermal Resistance, Junction to Case (Note 2)	25	$^\circ C/W$

Package Marking and Ordering Information

Device Marking	Device	Package	Reel Size	Tape Width	Quantity
FDS3672	FDS3672	SO-8	330mm	12mm	2500 units

Electrical Characteristics $T_A = 25^\circ\text{C}$ unless otherwise noted

Symbol	Parameter	Test Conditions	Min	Typ	Max	Units
--------	-----------	-----------------	-----	-----	-----	-------

Off Characteristics

B_{VDSS}	Drain to Source Breakdown Voltage	$I_D = 250\mu\text{A}$, $V_{GS} = 0\text{V}$	100	-	-	V
I_{DSS}	Zero Gate Voltage Drain Current	$V_{DS} = 80\text{V}$ $V_{GS} = 0\text{V}$	-	-	1	μA
		$T_C = 150^\circ\text{C}$	-	-	250	
I_{GSS}	Gate to Source Leakage Current	$V_{GS} = \pm 20\text{V}$	-	-	± 100	nA

On Characteristics

$V_{GS(TH)}$	Gate to Source Threshold Voltage	$V_{GS} = V_{DS}$, $I_D = 250\mu\text{A}$	2	-	4	V
$r_{DS(ON)}$	Drain to Source On Resistance	$I_D = 7.5\text{A}$, $V_{GS} = 10\text{V}$	-	0.019	0.023	Ω
		$I_D = 6.8\text{A}$, $V_{GS} = 6\text{V}$	-	0.023	0.028	
		$I_D = 7.5\text{A}$, $V_{GS} = 10\text{V}$, $T_C = 150^\circ\text{C}$	-	0.035	0.043	

Dynamic Characteristics

C_{ISS}	Input Capacitance	$V_{DS} = 25\text{V}$, $V_{GS} = 0\text{V}$, $f = 1\text{MHz}$	-	2015	-	pF
C_{OSS}	Output Capacitance		-	285	-	pF
C_{RSS}	Reverse Transfer Capacitance		-	70	-	pF
$Q_{g(TOT)}$	Total Gate Charge at 10V	$V_{GS} = 0\text{V}$ to 10V	-	28	37	nC
$Q_{g(TH)}$	Threshold Gate Charge	$V_{GS} = 0\text{V}$ to 2V	-	4	6	nC
Q_{gs}	Gate to Source Gate Charge	$V_{DD} = 50\text{V}$ $I_D = 7.5\text{A}$ $I_g = 1.0\text{mA}$	-	10	-	nC
Q_{gs2}	Gate Charge Threshold to Plateau		-	6.8	-	nC
Q_{gd}	Gate to Drain "Miller" Charge		-	6	-	nC

Switching Characteristics ($V_{GS} = 10\text{V}$)

t_{ON}	Turn-On Time	$V_{DD} = 50\text{V}$, $I_D = 4\text{A}$ $V_{GS} = 10\text{V}$, $R_{GS} = 10\Omega$	-	-	51	ns
$t_{d(ON)}$	Turn-On Delay Time		-	14	-	ns
t_r	Rise Time		-	20	-	ns
$t_{d(OFF)}$	Turn-Off Delay Time		-	37	-	ns
t_f	Fall Time		-	27	-	ns
t_{OFF}	Turn-Off Time		-	-	96	ns

Drain-Source Diode Characteristics

V_{SD}	Source to Drain Diode Voltage	$I_{SD} = 7.5\text{A}$	-	-	1.25	V
		$I_{SD} = 4\text{A}$	-	-	1.0	V
t_{rr}	Reverse Recovery Time	$I_{SD} = 7.5\text{A}$, $dI_{SD}/dt = 100\text{A}/\mu\text{s}$	-	-	55	ns
Q_{RR}	Reverse Recovered Charge	$I_{SD} = 7.5\text{A}$, $dI_{SD}/dt = 100\text{A}/\mu\text{s}$	-	-	90	nC

Notes:

1: Starting $T_j = 25^\circ\text{C}$, $L = 13\text{mH}$, $I_{AS} = 8\text{A}$.

2: $R_{\theta JA}$ is the sum of the junction-to-case and case-to-ambient thermal resistance where the case thermal reference is defined as the solder mounting surface of the drain pins. $R_{\theta JC}$ is guaranteed by design while $R_{\theta CA}$ is determined by the user's board design.

3: $R_{\theta JA}$ is measured with 1.0 in² copper on FR-4 board

Typical Characteristics $T_A = 25^\circ\text{C}$ unless otherwise noted

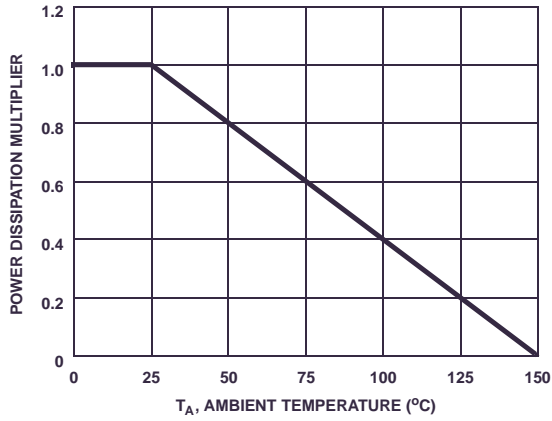

Figure 1. Normalized Power Dissipation vs Ambient Temperature

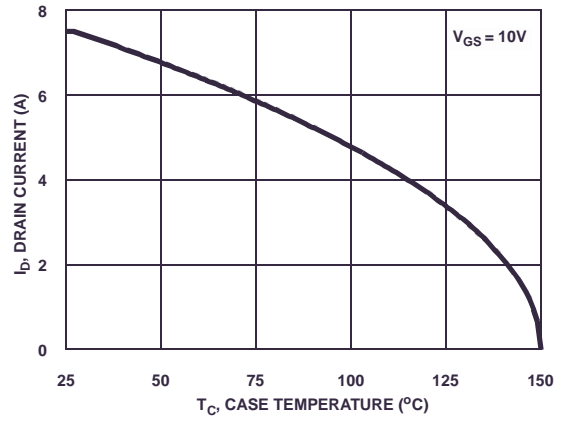

Figure 2. Maximum Continuous Drain Current vs Case Temperature

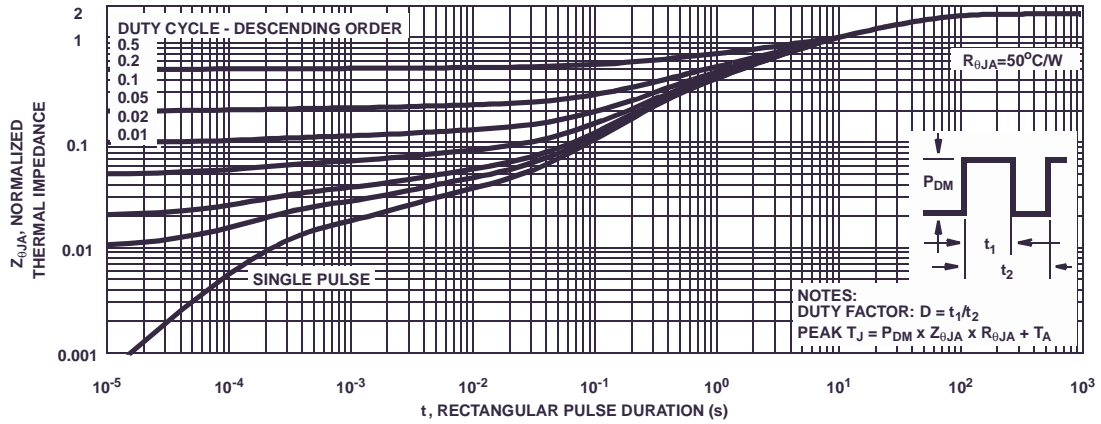

Figure 3. Normalized Maximum Transient Thermal Impedance

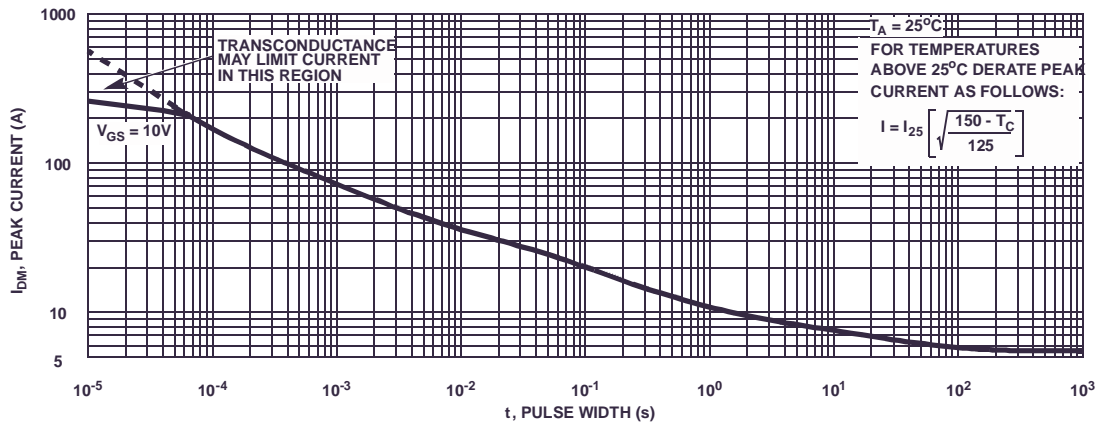

Figure 4. Peak Current Capability

Typical Characteristics $T_A = 25^\circ\text{C}$ unless otherwise noted

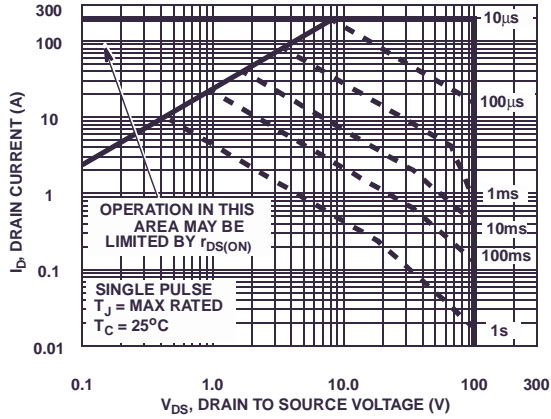

Figure 5. Forward Bias Safe Operating Area

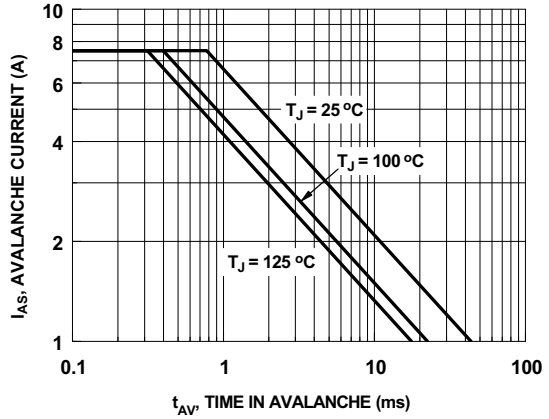

Figure 6. Unclamped Inductive Switching Capability

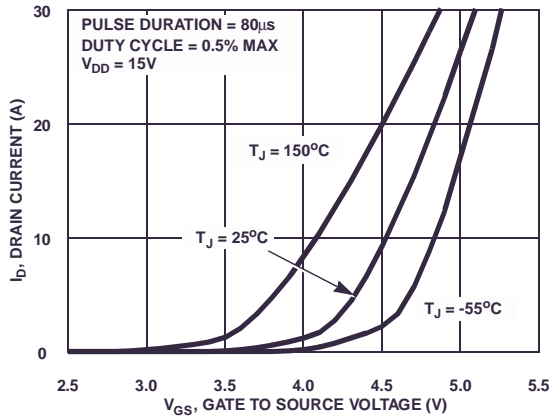

Figure 7. Transfer Characteristics

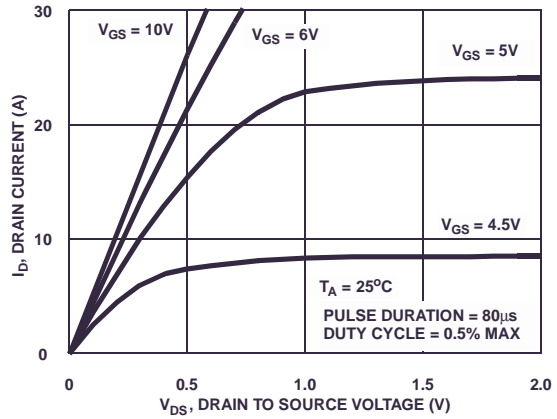

Figure 8. Saturation Characteristics

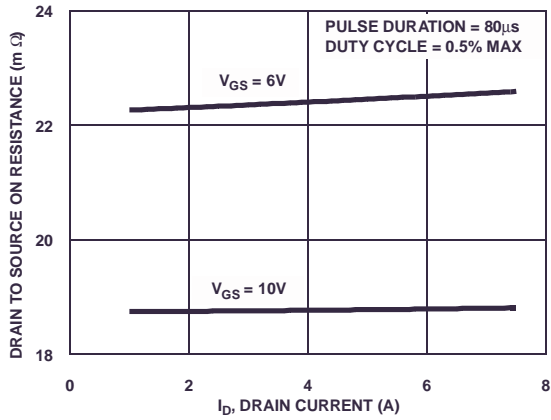

Figure 9. Drain to Source On Resistance vs Drain Current

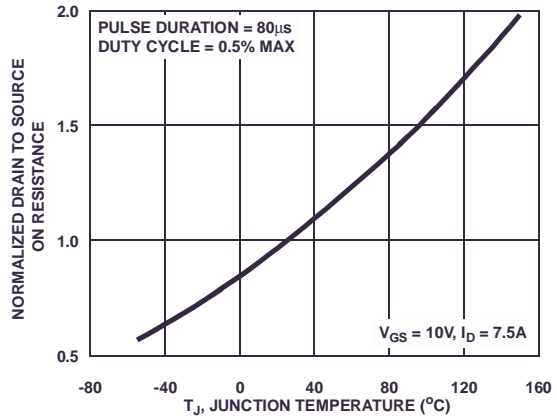

Figure 10. Normalized Drain to Source On Resistance vs Junction Temperature

Typical Characteristics $T_A = 25^\circ\text{C}$ unless otherwise noted

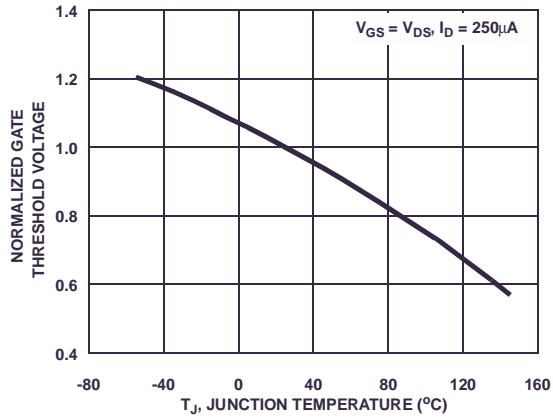

Figure 11. Normalized Gate Threshold Voltage vs Junction Temperature

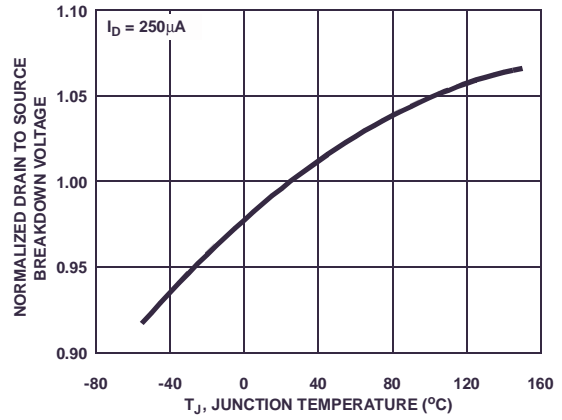

Figure 12. Normalized Drain to Source Breakdown Voltage vs Junction Temperature

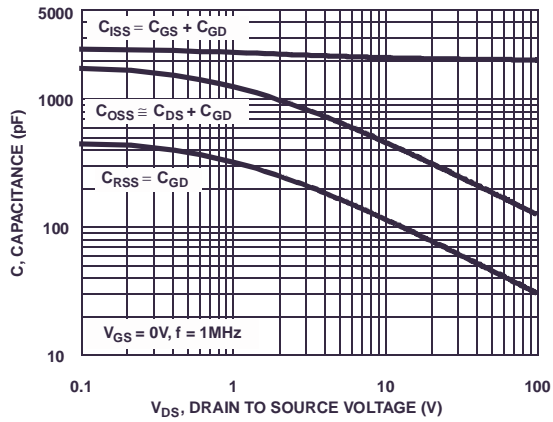

Figure 13. Capacitance vs Drain to Source Voltage

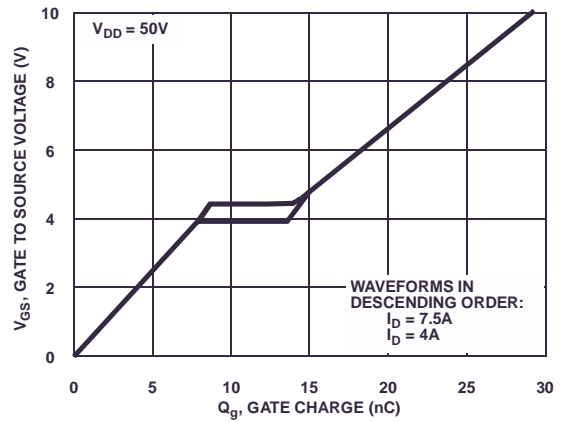

Figure 14. Gate Charge Waveforms for Constant Gate Currents

Test Circuits and Waveforms

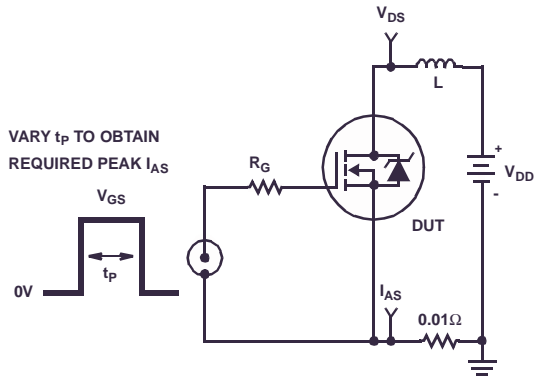

Figure 15. Unclamped Energy Test Circuit

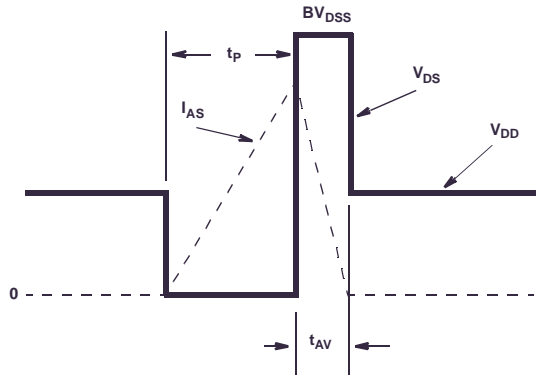

Figure 16. Unclamped Energy Waveforms

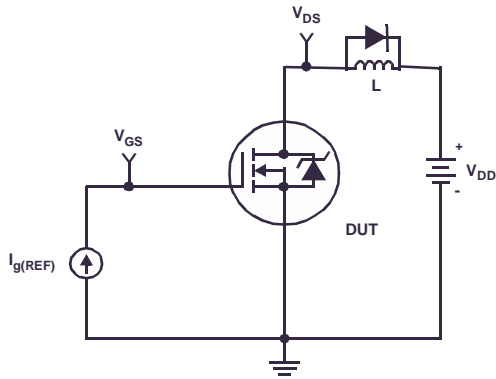

Figure 17. Gate Charge Test Circuit

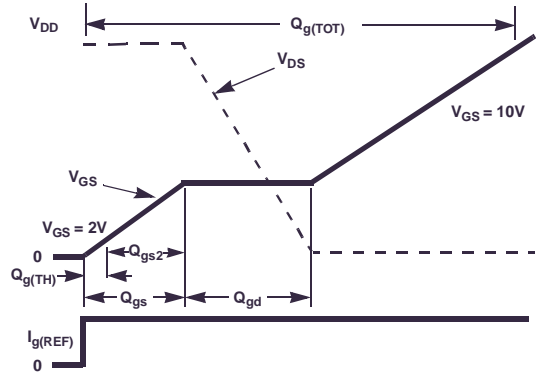

Figure 18. Gate Charge Waveforms

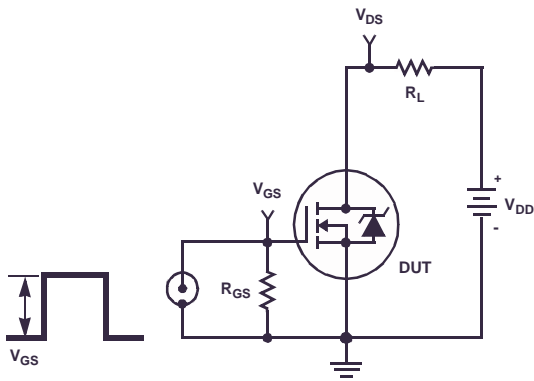

Figure 19. Switching Time Test Circuit

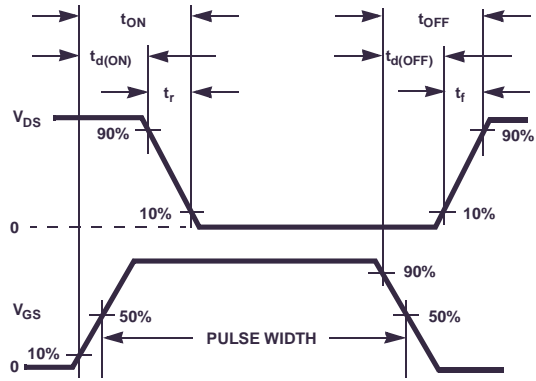







Figure 20. Switching Time Waveforms



TRADEMARKS

The following includes registered and unregistered trademarks and service marks, owned by Fairchild Semiconductor and/or its global subsidiaries, and is not intended to be an exhaustive list of all such trademarks.

- | | | | |
|---|---|--|---|
| 2Cool™ | F-PFST™ | PowerTrench® | The Power Franchise® |
| AccuPower™ | FRFET® | PowerXS™ | the power® |
| AX-CAP™* | Global Power Resource SM | Programmable Active Droop™ | franchise™ |
| BitSiC® | Green Bridge™ | QFET® | TinyBoost™ |
| Build it Now™ | Green FPS™ | QS™ | TinyBuck™ |
| CorePLUS™ | Green FPS™ e-Series™ | Quiet Series™ | TinyCalc™ |
| CorePOWER™ | Gmax™ | RapidConfigure™ | TinyLogic® |
| CROSSVOLT™ | GTO™ |  ™ | TINYOPTO™ |
| CTL™ | IntelliMAX™ | Saving our world, 1mW/W/kW at a time™ | TinyPower™ |
| Current Transfer Logic™ | ISOPLANAR™ | SignalWise™ | TinyPWM™ |
| DEUXPEED® | Marking Small Speakers Sound Louder and Better™ | SmartMax™ | TinyWire™ |
| Dual Cool™ | MegaBuck™ | SMART START™ | TranSiC® |
| EcoSPARK® | MICROCOUPLER™ | Solutions for Your Success™ | TriFault Detect™ |
| EfficientMax™ | MicroFET™ | SPM® | TRUECURRENT®* |
| ESBC™ | MicroPak™ | STEALTH™ | uSerDes™ |
|  ® | MicroPak2™ | SuperFET® |  ® |
| Fairchild® | MillerDrive™ | SuperSOT™-3 | UHC® |
| Fairchild Semiconductor® | MotionMax™ | SuperSOT™-6 | Ultra FRFET™ |
| FACT Quiet Series™ | Motion-SPM™ | SuperSOT™-8 | UniFET™ |
| FACT® | mWSaver™ | SupreMOS® | VCX™ |
| FAST® | OptoHiT™ | SyncFET™ | VisualMax™ |
| FastvCore™ | OPTOLOGIC® | Sync-Lock™ | VoltagePlus™ |
| FETBench™ | OPTOPLANAR® |  ®* | XST™ |
| FlashWriter®* |  ® | | |
| FPS™ | | | |

*Trademarks of System General Corporation, used under license by Fairchild Semiconductor.

DISCLAIMER

FAIRCHILD SEMICONDUCTOR RESERVES THE RIGHT TO MAKE CHANGES WITHOUT FURTHER NOTICE TO ANY PRODUCTS HEREIN TO IMPROVE RELIABILITY, FUNCTION, OR DESIGN. FAIRCHILD DOES NOT ASSUME ANY LIABILITY ARISING OUT OF THE APPLICATION OR USE OF ANY PRODUCT OR CIRCUIT DESCRIBED HEREIN; NEITHER DOES IT CONVEY ANY LICENSE UNDER ITS PATENT RIGHTS, NOR THE RIGHTS OF OTHERS. THESE SPECIFICATIONS DO NOT EXPAND THE TERMS OF FAIRCHILD'S WORLDWIDE TERMS AND CONDITIONS, SPECIFICALLY THE WARRANTY THEREIN, WHICH COVERS THESE PRODUCTS.

LIFE SUPPORT POLICY

FAIRCHILD'S PRODUCTS ARE NOT AUTHORIZED FOR USE AS CRITICAL COMPONENTS IN LIFE SUPPORT DEVICES OR SYSTEMS WITHOUT THE EXPRESS WRITTEN APPROVAL OF FAIRCHILD SEMICONDUCTOR CORPORATION.

As used here in:

- Life support devices or systems are devices or systems which, (a) are intended for surgical implant into the body or (b) support or sustain life, and (c) whose failure to perform when properly used in accordance with instructions for use provided in the labeling, can be reasonably expected to result in a significant injury of the user.
- A critical component in any component of a life support, device, or system whose failure to perform can be reasonably expected to cause the failure of the life support device or system, or to affect its safety or effectiveness.

ANTI-COUNTERFEITING POLICY

Fairchild Semiconductor Corporation's Anti-Counterfeiting Policy. Fairchild's Anti-Counterfeiting Policy is also stated on our external website, www.fairchildsemi.com, under Sales Support.

Counterfeiting of semiconductor parts is a growing problem in the industry. All manufactures of semiconductor products are experiencing counterfeiting of their parts. Customers who inadvertently purchase counterfeit parts experience many problems such as loss of brand reputation, substandard performance, failed application, and increased cost of production and manufacturing delays. Fairchild is taking strong measures to protect ourselves and our customers from the proliferation of counterfeit parts. Fairchild strongly encourages customers to purchase Fairchild parts either directly from Fairchild or from Authorized Fairchild Distributors who are listed by country on our web page cited above. Products customers buy either from Fairchild directly or from Authorized Fairchild Distributors are genuine parts, have full traceability, meet Fairchild's quality standards for handling and storage and provide access to Fairchild's full range of up-to-date technical and product information. Fairchild and our Authorized Distributors will stand behind all warranties and will appropriately address and warranty issues that may arise. Fairchild will not provide any warranty coverage or other assistance for parts bought from Unauthorized Sources. Fairchild is committed to combat this global problem and encourage our customers to do their part in stopping this practice by buying direct or from authorized distributors.

PRODUCT STATUS DEFINITIONS

Definition of Terms

Datasheet Identification	Product Status	Definition
Advance Information	Formative / In Design	Datasheet contains the design specifications for product development. Specifications may change in any manner without notice.
Preliminary	First Production	Datasheet contains preliminary data; supplementary data will be published at a later date. Fairchild Semiconductor reserves the right to make changes at any time without notice to improve design.
No Identification Needed	Full Production	Datasheet contains final specifications. Fairchild Semiconductor reserves the right to make changes at any time without notice to improve the design.
Obsolete	Not In Production	Datasheet contains specifications on a product that is discontinued by Fairchild Semiconductor. The datasheet is for reference information only.