

ZXTP2041F

40V PNP SILICON PLANAR MEDIUM POWER TRANSISTOR

Features

- $V_{(BR)CEO} > -40V$
- High current capability $I_C = -1A$
- Low saturation voltage $V_{CE(sat)} < -500mV @ -1A$
- "Lead Free", RoHS Compliant (Note 1)

Application

- Power MOSFET gate driving
- Low loss power switching

Mechanical Data

- Case: SOT23
- Moisture Sensitivity: Level 1 per J-STD-020
- UL Flammability Rating 94V-0
- Terminals: Matte Tin Finish
- Weight: 0.008 grams (Approximate)



Top View

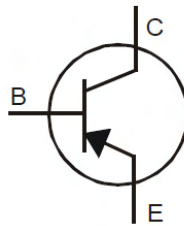

Device symbol

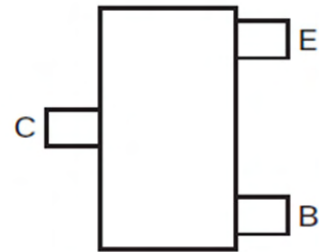

Pin-out Top

Ordering Information (Note 2)

| Product | Marking | Reel size (inches) | Tape width (mm) | Quantity per reel |
|-------------|---------|--------------------|-----------------|-------------------|
| ZXTP2041FTA | P41 | 7 | 8 | 3,000 |

- Notes:
1. No purposefully added lead.
 2. For packaging details, go to our website at <http://www.diodes.com>.

Marking Information

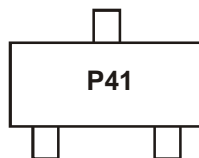

P41 = Product Type Marking Code

Maximum Ratings @ $T_A = 25^\circ\text{C}$ unless otherwise specified

| Characteristic | Symbol | Value | Unit |
|---------------------------------------|-----------|-------|------|
| Collector-Base Voltage | V_{CBO} | -40 | V |
| Collector-Emitter Voltage | V_{CEO} | -40 | V |
| Emitter-Base Voltage | V_{EBO} | -5 | V |
| Continuous Collector Current (Note 3) | I_C | -1 | A |
| Peak Pulse Current | I_{CM} | -2 | A |
| Peak Base Current | I_{BM} | -1 | A |

Thermal Characteristics @ $T_A = 25^\circ\text{C}$ unless otherwise specified

| Characteristic | Symbol | Value | Unit |
|--|-----------------|-------------|--------------------|
| Collector Power Dissipation (Note 3) | P_D | 350 | mW |
| Thermal Resistance, Junction to Ambient (Note 3) | $R_{\theta JA}$ | 357 | $^\circ\text{C/W}$ |
| Operating and Storage Temperature Range | T_J, T_{STG} | -55 to +150 | $^\circ\text{C}$ |

Notes: 3. For the device mounted on 15mm x 15mm x 1.6mm FR4 PCB with high coverage of single sided 1oz copper, in still air conditions.

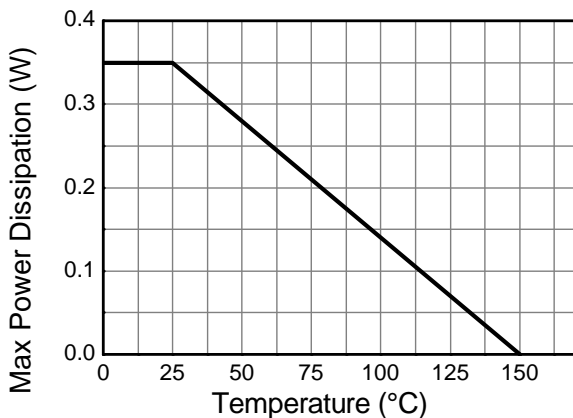

Derating Curve

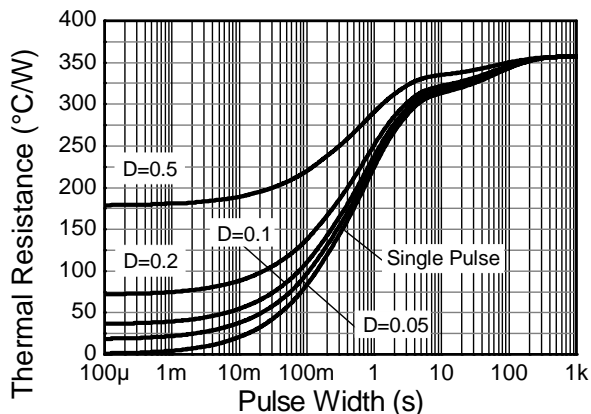

Transient Thermal Impedance

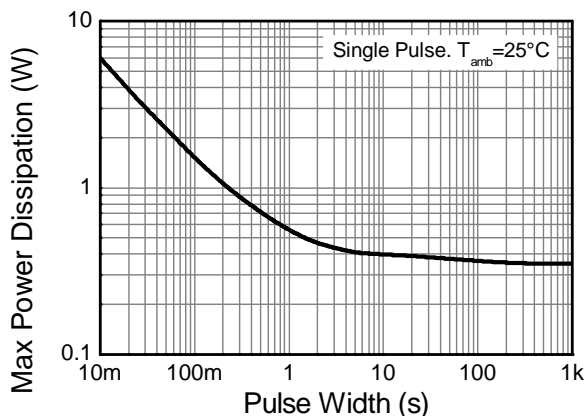

Pulse Power Dissipation

Electrical Characteristics @T_A = 25°C unless otherwise specified

| Characteristic | Symbol | Min | Typ. | Max | Unit | Test Condition |
|---|----------------------|------------------|------|-------|------|--|
| Collector-Base Breakdown Voltage | V _{(BR)CBO} | -40 | - | - | V | I _C = -100μA |
| Collector-Emitter Breakdown Voltage (Note 4) | V _{(BR)CEO} | -40 | - | - | V | I _C = -10mA |
| Emitter-Base Breakdown Voltage | V _{(BR)EBO} | -5 | - | - | V | I _E = -100μA |
| Collector Cutoff Current | I _{CBO} | - | - | -100 | nA | V _{CB} = -30V |
| Emitter Cutoff Current | I _{EBO} | - | - | -100 | nA | V _{EB} = -4V |
| Emitter Cutoff Current | I _{CES} | - | - | -100 | nA | V _{CE} = -30V |
| DC current transfer Static ratio (Note 4) | h _{FE} | 300 | - | - | - | I _C = -1mA, V _{CE} = -5V |
| | | 300 | - | 800 | | I _C = -100mA, V _{CE} = -5V |
| | | 250 | - | - | | I _C = -500mA, V _{CE} = -5V |
| | | 160 | - | - | | I _C = -1A, V _{CE} = -5V |
| | | 30 | - | - | | I _C = -2A, V _{CE} = -5V |
| Collector-Emitter Saturation Voltage (Note 4) | V _{CE(sat)} | - | - | -0.20 | V | I _C = -100mA, I _B = -1mA |
| | | - | - | -0.35 | | I _C = -500mA, I _B = -20mA |
| | | - | - | -0.50 | | I _C = -1A, I _B = -100mA |
| Base-Emitter Saturation Voltage (Note 4) | V _{BE(sat)} | - | - | -1.1 | V | I _C = -1A, I _B = -100mA |
| Base-Emitter Turn-on Voltage (Note 4) | V _{BE(on)} | - | - | -1.0 | V | I _C = -1A, V _{CE} = -5V |
| Transitional Frequency | f _T | 150 | 300 | - | MHz | I _C = -50mA, V _{CE} = -10V, f = 100MHz |
| Output capacitance | C _{obo} | - | - | 10 | pF | V _{CB} = -10V, f = 1MHz, |
| Switching Time | Delay Time | t _(d) | - | 34.9 | ns | V _{CC} = -10V, I _C = -500mA, I _{B1} = -I _{B2} = 25mA |
| | Rise Time | t _(r) | - | 19.2 | | |
| | Storage Time | t _(s) | - | 249 | | |
| | Fall Time | t _(f) | - | 62 | | |

Notes: 4. Measured under pulsed conditions. Pulse width = 300μs. Duty cycle ≤2%.

Typical Characteristics

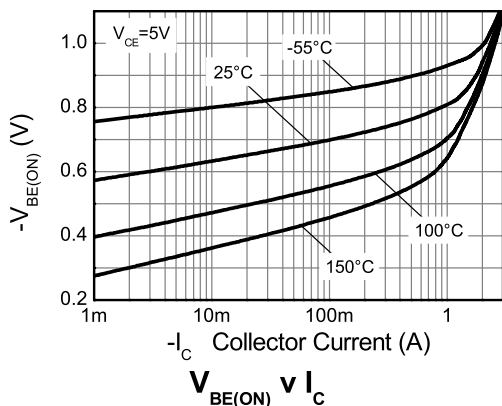
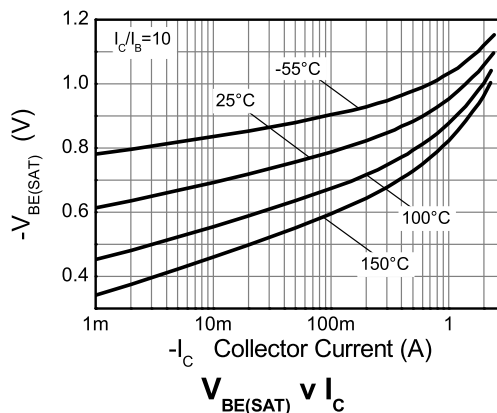
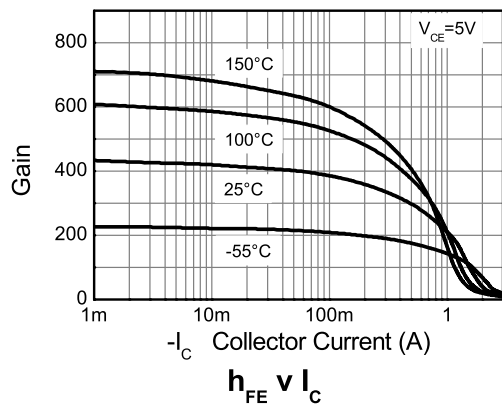
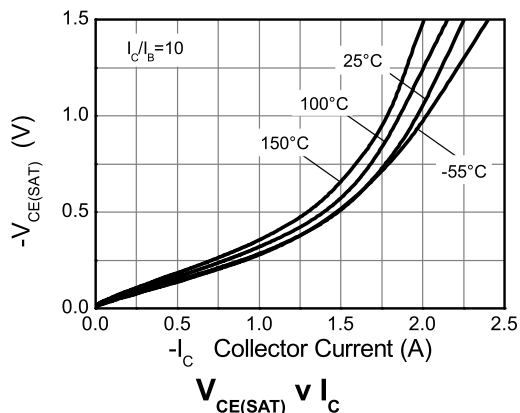
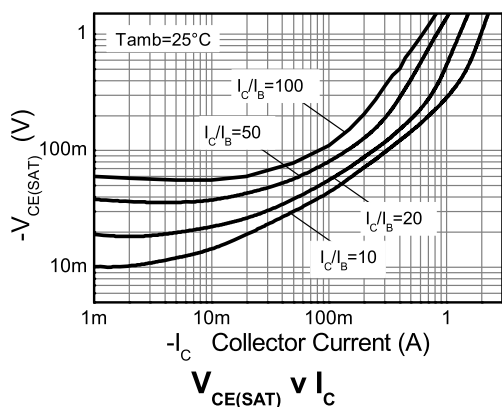

Package Outline Dimensions

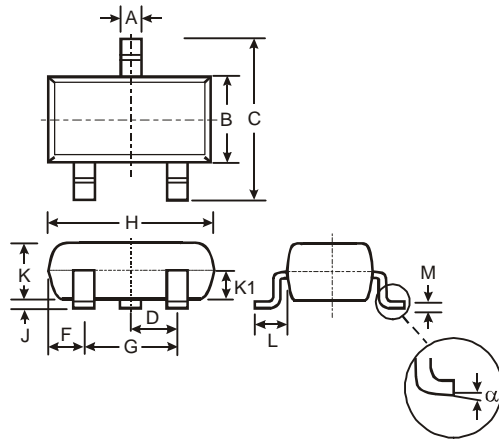

| SOT23 | | | |
|----------------------|-------|------|-------|
| Dim | Min | Max | Typ |
| A | 0.37 | 0.51 | 0.40 |
| B | 1.20 | 1.40 | 1.30 |
| C | 2.30 | 2.50 | 2.40 |
| D | 0.89 | 1.03 | 0.915 |
| F | 0.45 | 0.60 | 0.535 |
| G | 1.78 | 2.05 | 1.83 |
| H | 2.80 | 3.00 | 2.90 |
| J | 0.013 | 0.10 | 0.05 |
| K | 0.903 | 1.10 | 1.00 |
| K1 | - | - | 0.400 |
| L | 0.45 | 0.61 | 0.55 |
| M | 0.085 | 0.18 | 0.11 |
| α | 0° | 8° | - |
| All Dimensions in mm | | | |

Suggested Pad Layout

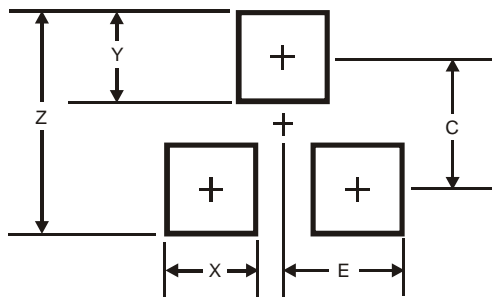

| Dimensions | Value (in mm) |
|------------|---------------|
| Z | 2.9 |
| X | 0.8 |
| Y | 0.9 |
| C | 2.0 |
| E | 1.35 |

IMPORTANT NOTICE

DIODES INCORPORATED MAKES NO WARRANTY OF ANY KIND, EXPRESS OR IMPLIED, WITH REGARDS TO THIS DOCUMENT, INCLUDING, BUT NOT LIMITED TO, THE IMPLIED WARRANTIES OF MERCHANTABILITY AND FITNESS FOR A PARTICULAR PURPOSE (AND THEIR EQUIVALENTS UNDER THE LAWS OF ANY JURISDICTION).

Diodes Incorporated and its subsidiaries reserve the right to make modifications, enhancements, improvements, corrections or other changes without further notice to this document and any product described herein. Diodes Incorporated does not assume any liability arising out of the application or use of this document or any product described herein; neither does Diodes Incorporated convey any license under its patent or trademark rights, nor the rights of others. Any Customer or user of this document or products described herein in such applications shall assume all risks of such use and will agree to hold Diodes Incorporated and all the companies whose products are represented on Diodes Incorporated website, harmless against all damages.

Diodes Incorporated does not warrant or accept any liability whatsoever in respect of any products purchased through unauthorized sales channel. Should Customers purchase or use Diodes Incorporated products for any unintended or unauthorized application, Customers shall indemnify and hold Diodes Incorporated and its representatives harmless against all claims, damages, expenses, and attorney fees arising out of, directly or indirectly, any claim of personal injury or death associated with such unintended or unauthorized application.

Products described herein may be covered by one or more United States, international or foreign patents pending. Product names and markings noted herein may also be covered by one or more United States, international or foreign trademarks.

LIFE SUPPORT

Diodes Incorporated products are specifically not authorized for use as critical components in life support devices or systems without the express written approval of the Chief Executive Officer of Diodes Incorporated. As used herein:

A. Life support devices or systems are devices or systems which:

1. are intended to implant into the body, or
2. support or sustain life and whose failure to perform when properly used in accordance with instructions for use provided in the labeling can be reasonably expected to result in significant injury to the user.

B. A critical component is any component in a life support device or system whose failure to perform can be reasonably expected to cause the failure of the life support device or to affect its safety or effectiveness.

Customers represent that they have all necessary expertise in the safety and regulatory ramifications of their life support devices or systems, and acknowledge and agree that they are solely responsible for all legal, regulatory and safety-related requirements concerning their products and any use of Diodes Incorporated products in such safety-critical, life support devices or systems, notwithstanding any devices- or systems-related information or support that may be provided by Diodes Incorporated. Further, Customers must fully indemnify Diodes Incorporated and its representatives against any damages arising out of the use of Diodes Incorporated products in such safety-critical, life support devices or systems.

Copyright © 2010, Diodes Incorporated

www.diodes.com