FCX555

180V High voltage PNP switching transistor in SOT89

Summary

$BV_{CEV} > -180V$

Description

Packaged in the SOT89 outline this new high gain medium power PNP transistor offers 180V forward blocking capability making it ideal for use in VOIC and various driving and power management functions.

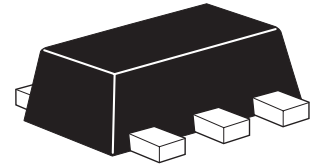

Features

- 180 volts forward blocking

Applications

- Voice over internet protocol (VOIC)
- MOSFET gate drivers
- Power switches
- Motor control

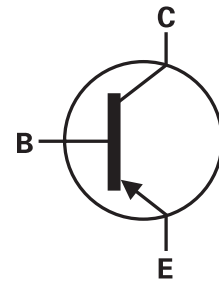

Ordering information

Device	Reel size	Tape width	Quantity per reel
FCX555TA	7"	12mm embossed	1,000

Device marking

555

Pin out - top view

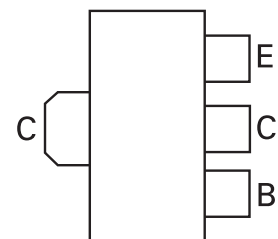

Absolute maximum ratings

Parameter	Symbol	Limit	Unit
Collector-base voltage	V_{CBO}	-180	V
Collector-emitter voltage	V_{CEV}	-180	V
Emitter-base voltage	V_{EBO}	-7	V
Continuous collector current ^(a)	I_C	-0.7	A
Peak pulse current	I_{CM}	-2	A
Power dissipation at $T_A = 25^\circ\text{C}^{(a)}$	P_D	1.5	W
Linear derating factor		12	mW/°C
Power dissipation at $T_A = 25^\circ\text{C}^{(b)}$	P_D	2.1	W
Linear derating factor		16.8	mW/°C
Operating and storage temperature range	$T_j; T_{stg}$	-55 to +150	°C

Thermal resistance

Parameter	Symbol	Value	Unit
Junction to ambient ^(a)	$R\theta_{JA}$	83	°C/W

NOTES:

- (a) For a device surface mounted on 25mm x 25mm x 1.6mm FR4 PCB with high coverage of single sided 1oz copper, in still air conditions.
- (b) For a device surface mounted on 50mm x 50mm x 1.6mm FR4 PCB with high coverage of single sided 1oz copper, in still air conditions.

Electrical characteristics

Parameter	Symbol	Min.	Typ.	Max.	Unit	Conditions
Collector-base breakdown voltage	BV_{CBO}	-180			V	$I_C = -100\mu A$
Collector-emitter breakdown voltage	BV_{CEV}	-180			V	$I_C = -1\mu A$, $-0.3V < V_{BE} < 1V$
Collector-emitter breakdown voltage	BV_{CER}	-180			V	$I_C = -1\mu A$, $R_B \leq 1k\Omega$
Emitter-base breakdown voltage	BV_{EBO}	-7	-8.1		V	$I_E = -100\mu A$
Collector-emitter breakdown voltage	BV_{CEO}	-150			V	$I_C = -10mA^{(*)}$
Collector cut-off current	I_{CBO}		<1	-20 -10	nA μA	$V_{CB} = -144V$ $V_{CB} = -144V$, $T_{AMB} = 100^\circ C$
Emitter cut-off current	I_{EBO}		<1	-20	nA	$V_{EB} = -6V$
Collector emitter saturation voltage	$V_{CE(SAT)}$			-300 -400	mV mV	$I_C = -0.1A$, $I_B = -10mA^{(*)}$ $I_C = -0.25A$, $I_B = -25mA^{(*)}$
Base-emitter saturation voltage	$V_{BE(SAT)}$			-1000	mV	$I_C = -250mA$, $I_B = -25mA^{(*)}$
Base-emitter turn-on voltage	$V_{BE(ON)}$			-950	mV	$I_C = -250mA$, $V_{CE} = -5V^{(*)}$
Static forward current transfer ratio	h_{FE}	100 100		300		$I_C = -10mA$, $V_{CE} = -5V^{(*)}$ $I_C = -100mA$, $V_{CE} = -5V^{(*)}$
Transition frequency	f_T		100		MHz	$I_C = -50mA$, $V_{CE} = -10V$, $f = 100MHz$
Output capacitance	C_{OBO}			10	pF	$V_{CB} = -10V$, $f = 1MHz^{(*)}$

NOTES:

(*) Measured under pulsed conditions. Pulse width $\leq 300\mu s$; duty cycle $\leq 2\%$.

Typical characteristics

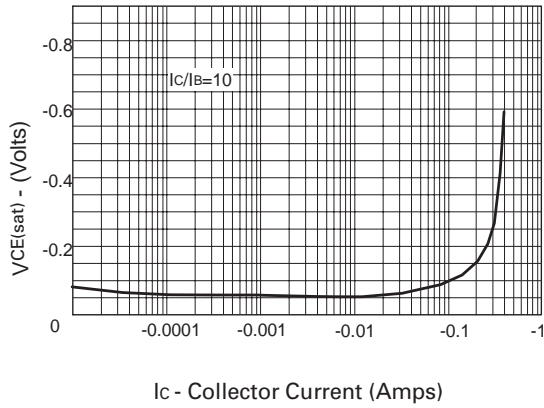

$V_{CE(sat)}$ v I_C

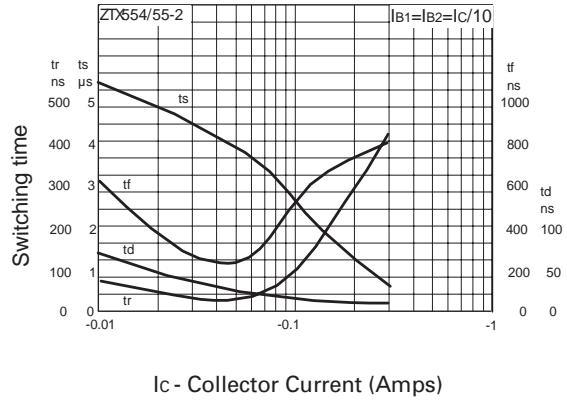

Switching Speeds

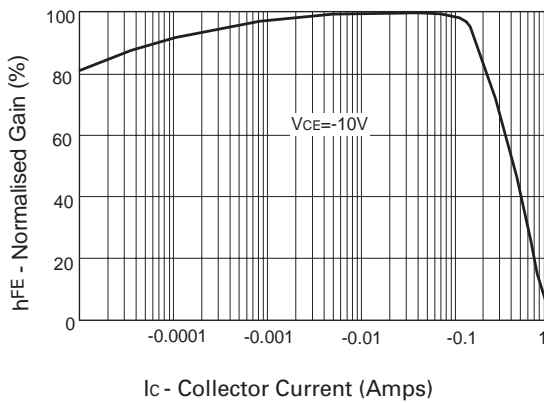

h_{FE} v I_C

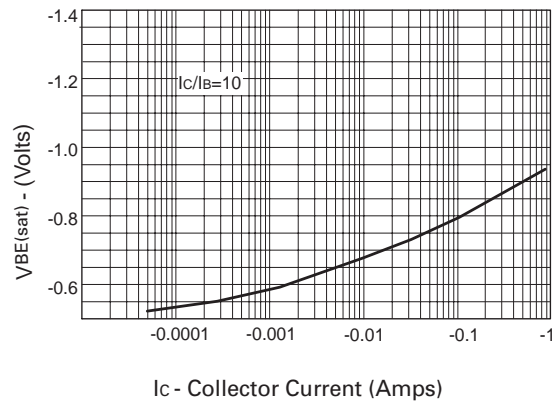

$V_{BE(sat)}$ v I_C

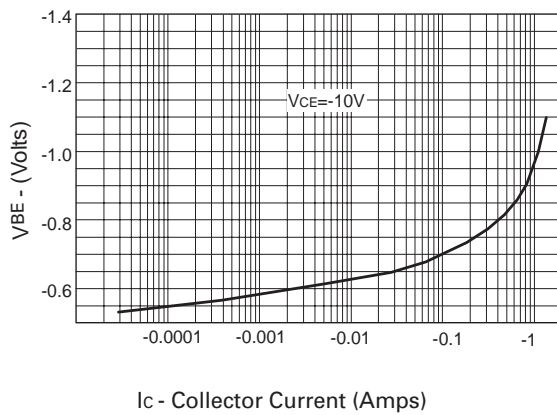

$V_{BE(on)}$ v I_C

Intentionally left blank

SOT89 Packaging details

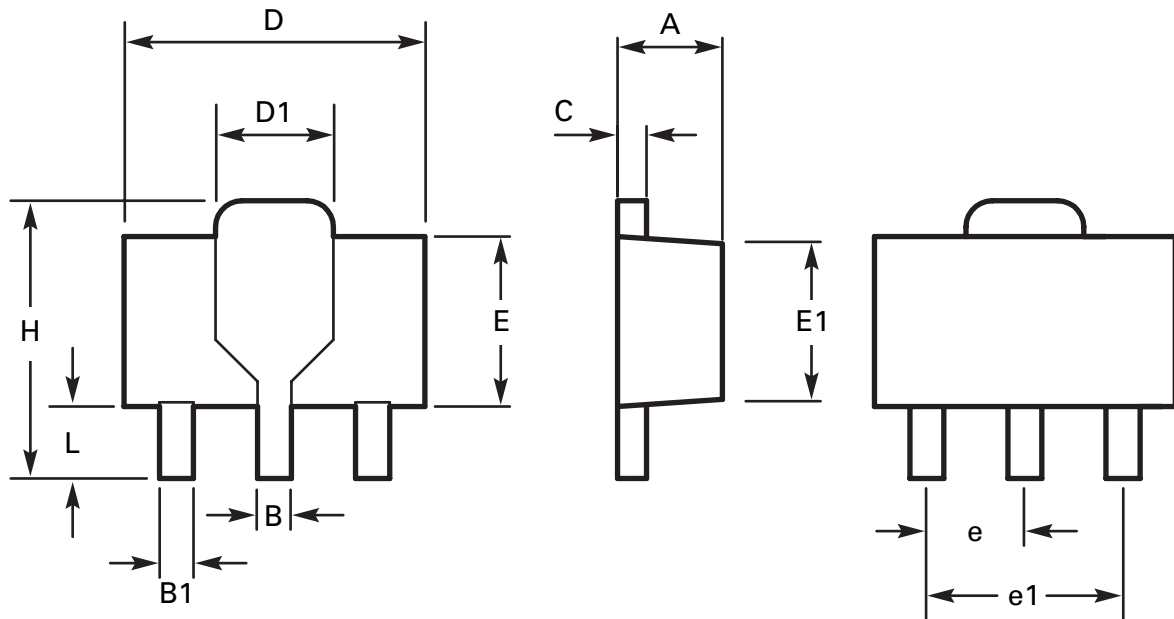

DIM	Millimeters		Inches		DIM	Millimeters		Inches	
	Min	Max	Min	Max		Min	Max	Min	Max
A	1.40	1.60	0.550	0.630	E1	2.13	2.29	0.084	0.090
B	0.44	0.56	0.017	0.022	e	1.50 BSC		0.059 BSC	
B1	0.36	0.48	0.014	0.019	e1	3.00 BSC		0.118 BSC	
C	0.35	0.44	0.014	0.019	H	3.94	4.25	0.155	0.167
D	4.40	4.60	0.173	0.181	L	0.89	1.20	0.155	0.167
E	2.29	2.60	0.090	0.102		-	-	-	-

Note: Controlling dimensions are in millimeters. Approximate dimensions are provided in inches

Europe

Zetex GmbH
Streitfeldstraße 19
D-81673 München
Germany

Telefon: (49) 89 45 49 49 0
Fax: (49) 89 45 49 49 49
europe.sales@zetex.com

Americas

Zetex Inc
700 Veterans Memorial Highway
Hauppauge, NY 11788
USA

Telephone: (1) 631 360 2222
Fax: (1) 631 360 8222
usa.sales@zetex.com

Asia Pacific

Zetex (Asia Ltd)
3701-04 Metroplaza Tower 1
Hing Fong Road, Kwai Fong
Hong Kong

Telephone: (852) 26100 611
Fax: (852) 24250 494
asia.sales@zetex.com

Corporate Headquarters

Zetex Semiconductors plc
Zetex Technology Park, Chadderton
Oldham, OL9 9LL
United Kingdom

Telephone (44) 161 622 4444
Fax: (44) 161 622 4446
hq@zetex.com

These offices are supported by agents and distributors in major countries world-wide.

This publication is issued to provide outline information only which (unless agreed by the company in writing) may not be used, applied or reproduced for any purpose or form part of any order or contact or be regarded as a representation relating to the products or services concerned. The company reserves the right to alter without notice the specification, design, price or conditions of supply of any product or service.