

SKM 600GA176D



SEMITRANS® 4

Trench IGBT Modules

SKM 600GA176D

Features

- Homogeneous Si
- Trench = Trenchgate technology
- $V_{CE(sat)}$ with positive temperature coefficient
- High short circuit capability, self limiting to $6 \times I_C$

Typical Applications*

- AC inverter drives mains 575 - 790 V AC
- Public transport (auxiliary systems)

Remarks

- $I_{DC} \leq 500$ A limited for $T_{Terminal} = 100^\circ\text{C}$

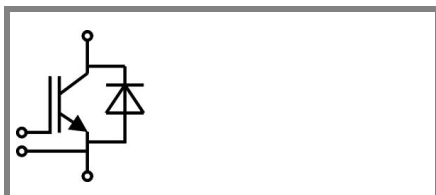

GA

Absolute Maximum Ratings		$T_{case} = 25^\circ\text{C}$, unless otherwise specified			
Symbol	Conditions	Values			Units
IGBT					
V_{CES}	$T_j = 25^\circ\text{C}$	1700			V
I_C	$T_j = 150^\circ\text{C}$	$T_c = 25^\circ\text{C}$	660		A
		$T_c = 80^\circ\text{C}$	470		A
I_{CRM}	$I_{CRM} = 2 \times I_{Cnom}$	800			A
V_{GES}		± 20			V
t_{psc}	$V_{CC} = 1200$ V; $V_{GE} \leq 20$ V; $T_j = 125^\circ\text{C}$ $V_{CES} < 1700$ V	10			μs
Inverse Diode					
I_F	$T_j = 150^\circ\text{C}$	$T_c = 25^\circ\text{C}$	600		A
		$T_c = 80^\circ\text{C}$	410		A
I_{FRM}	$I_{FRM} = 2 \times I_{Fnom}$	800			A
I_{FSM}	$t_p = 10$ ms; sin.	$T_j = 150^\circ\text{C}$	3800		A
Module					
$I_{t(RMS)}$		500			A
T_{vj}		- 40 ... +150			$^\circ\text{C}$
T_{stg}		- 40 ... +125			$^\circ\text{C}$
V_{isol}	AC, 1 min.	4000			V

Characteristics		$T_{case} = 25^\circ\text{C}$, unless otherwise specified				
Symbol	Conditions	min.	typ.	max.	Units	
IGBT						
$V_{GE(th)}$	$V_{GE} = V_{CE}$, $I_C = 16$ mA	5,2	5,8	6,4	V	
I_{CES}	$V_{GE} = 0$ V, $V_{CE} = V_{CES}$			4	mA	
V_{CE0}		$T_j = 25^\circ\text{C}$	1		1,2	V
		$T_j = 125^\circ\text{C}$	0,9		1,1	V
r_{CE}	$V_{GE} = 15$ V	$T_j = 25^\circ\text{C}$	2,5		3,1	m Ω
		$T_j = 125^\circ\text{C}$	3,9		4,5	m Ω
$V_{CE(sat)}$	$I_{Cnom} = 400$ A, $V_{GE} = 15$ V	$T_j = 25^\circ\text{C}_{chiplev.}$	2		2,45	V
		$T_j = 125^\circ\text{C}_{chiplev.}$	2,45		2,9	V
C_{res}	$V_{CE} = 25$, $V_{GE} = 0$ V	$f = 1$ MHz	28,4		nF	
C_{oes}			1,46		nF	
C_{res}			1,17		nF	
$t_{d(on)}$	$R_{Gon} = 3 \Omega$	$V_{CC} = 1200$ V $I_C = 400$ A	290		ns	
t_r			70		ns	
E_{on}	$R_{Goff} = 3 \Omega$	$T_j = 125^\circ\text{C}$ $V_{GE} = \pm 15$ V	255		mJ	
$t_{d(off)}$			890		ns	
t_f			160		ns	
E_{off}			155		mJ	
$R_{th(j-c)}$	per IGBT	0,044			K/W	

SKM 600GA176D



SEMITRANS® 4

Trench IGBT Modules

SKM 600GA176D

Features

- Homogeneous Si
- Trench = Trenchgate technology
- $V_{CE(sat)}$ with positive temperature coefficient
- High short circuit capability, self limiting to $6 \times I_C$

Typical Applications*

- AC inverter drives mains 575 - 790 V AC
- Public transport (auxiliary systems)

Remarks

- $I_{DC} \leq 500$ A limited for $T_{Terminal} = 100^\circ\text{C}$

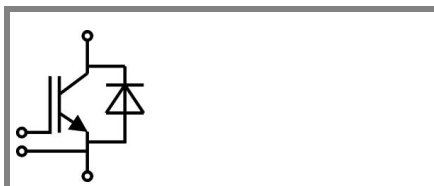

GA

Characteristics

Symbol	Conditions	min.	typ.	max.	Units
Inverse Diode					
$V_F = V_{EC}$	$I_{Fnom} = 400$ A; $V_{GE} = 0$ V				
	$T_j = 25^\circ\text{C}_{chiplev.}$		1,6	1,9	V
	$T_j = 125^\circ\text{C}_{chiplev.}$		1,6	1,9	V
V_{F0}			1,1	1,3	V
r_F			1,3	1,5	mΩ
I_{RRM}	$I_F = 400$ A				A
Q_{rr}	$di/dt = 5700$ A/μs		510		μC
E_{rr}	$V_{GE} = -15$ V; $V_{CC} = 1200$ V		102		mJ
$R_{th(j-c)D}$	per diode			0,09	K/W
Module					
L_{CE}			15	20	nH
R_{CC+EE}	res., terminal-chip	$T_{case} = 25^\circ\text{C}$	0,18		mΩ
		$T_{case} = 125^\circ\text{C}$	0,22		mΩ
$R_{th(c-s)}$	per module			0,038	K/W
M_s	to heat sink M6		3	5	Nm
M_t	to terminals M6 (M4)		2,5 (1,1)	5 (2)	Nm
w				330	g

This is an electrostatic discharge sensitive device (ESDS), international standard IEC 60747-1, Chapter IX.

* The specifications of our components may not be considered as an assurance of component characteristics. Components have to be tested for the respective application. Adjustments may be necessary. The use of SEMIKRON products in life support appliances and systems is subject to prior specification and written approval by SEMIKRON. We therefore strongly recommend prior consultation of our personal.

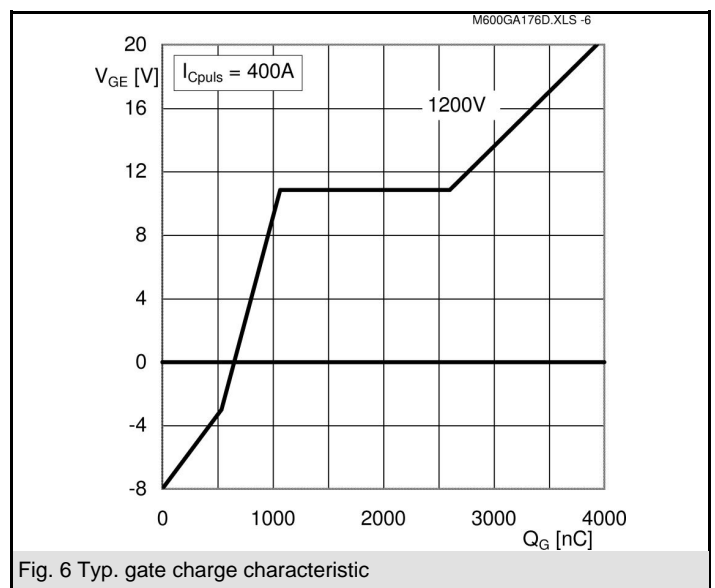
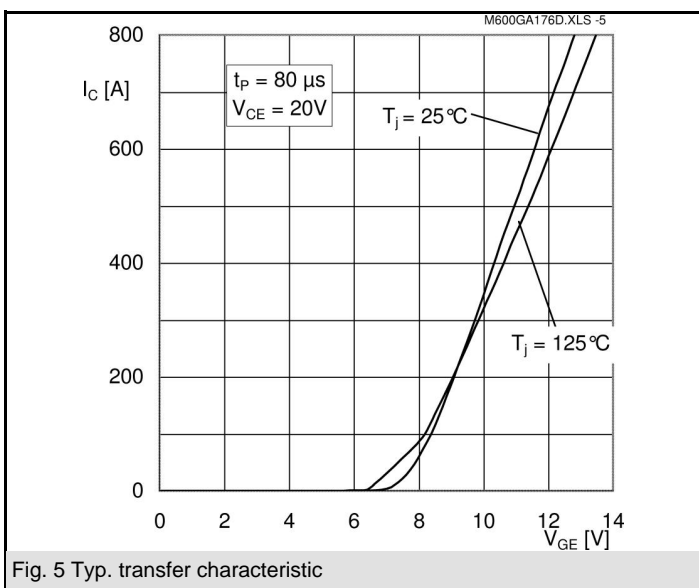
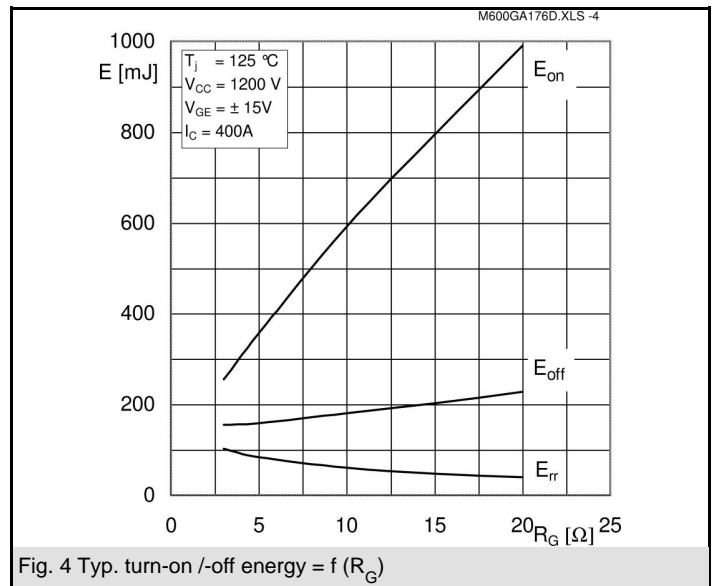
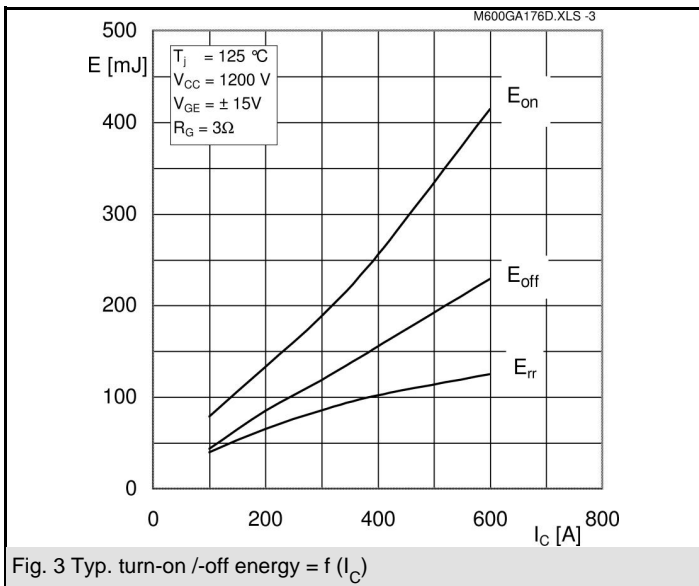
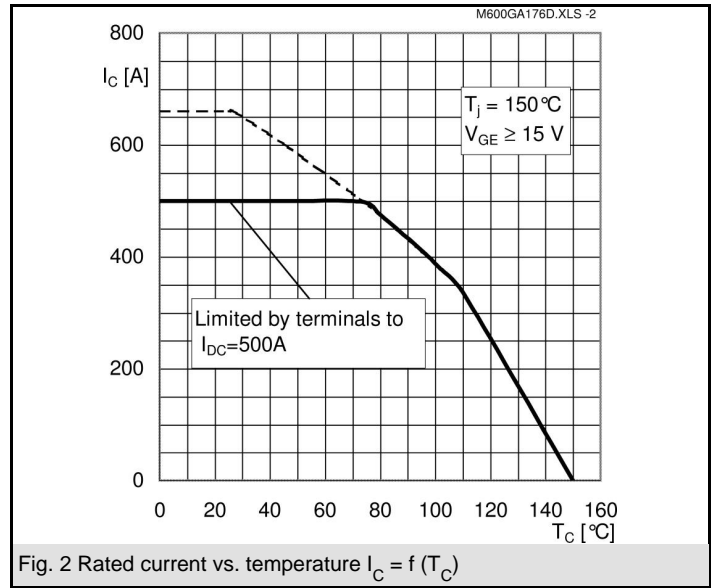
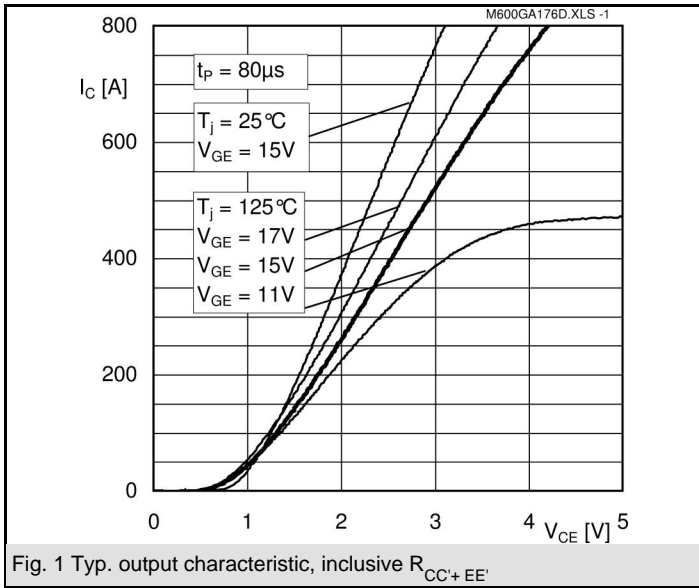

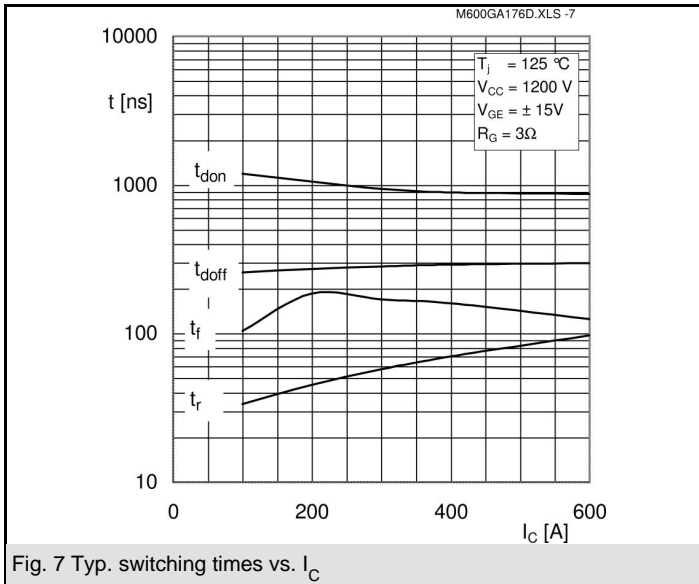

Fig. 7 Typ. switching times vs. I_C

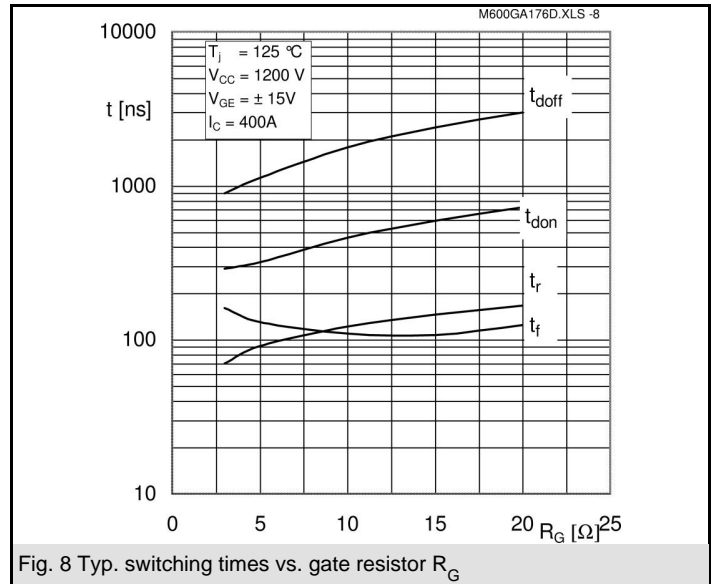

Fig. 8 Typ. switching times vs. gate resistor R_G

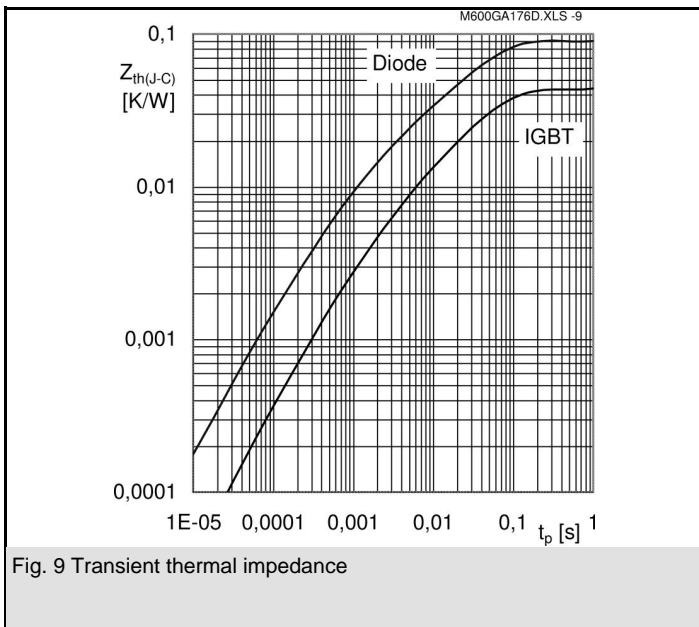

Fig. 9 Transient thermal impedance

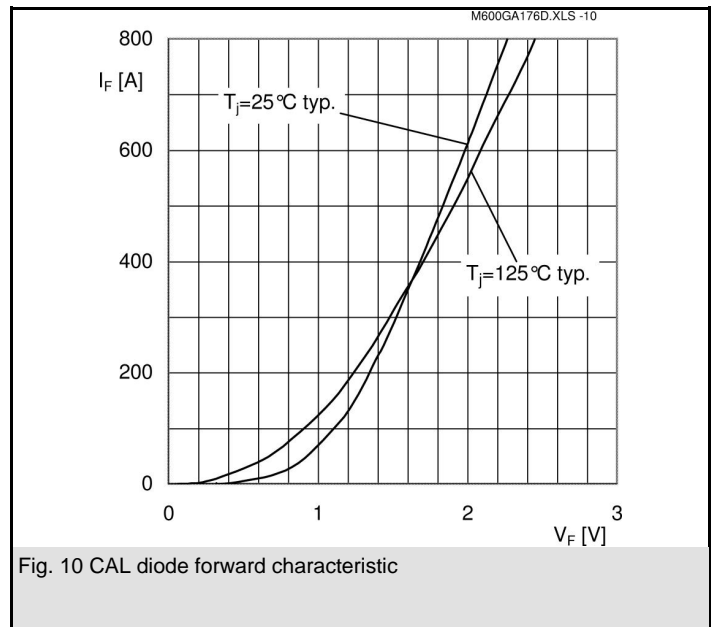

Fig. 10 CAL diode forward characteristic

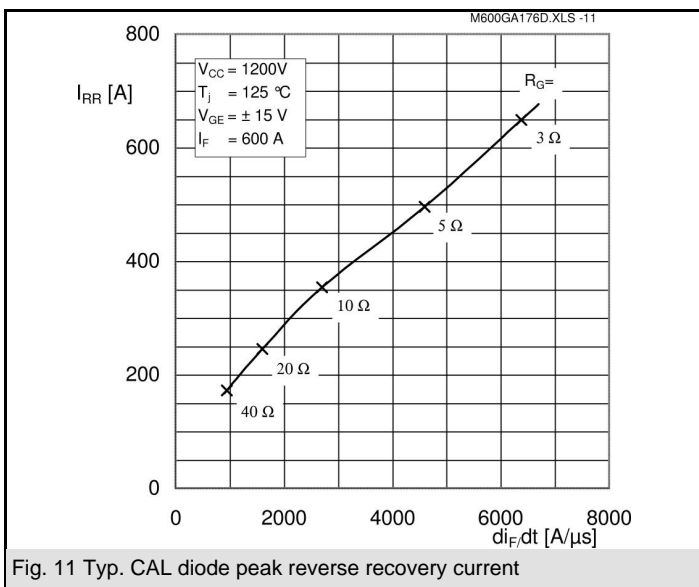

Fig. 11 Typ. CAL diode peak reverse recovery current

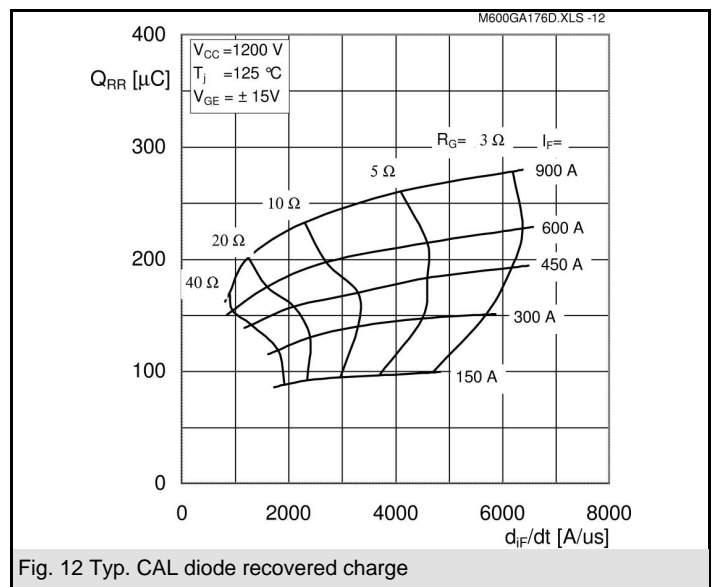

Fig. 12 Typ. CAL diode recovered charge

SKM 600GA176D

UL Recognized

CASED59

File no. 63 532

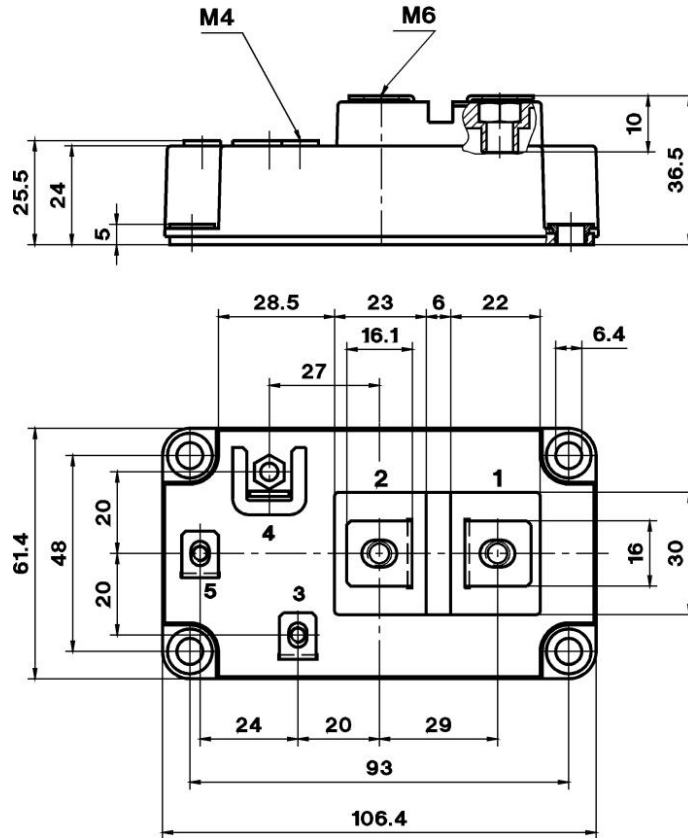

Case D 59

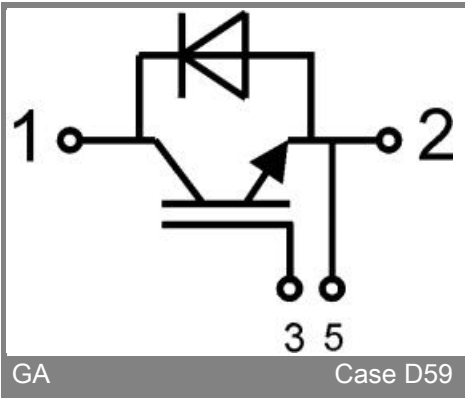

GA

Case D59