

SKM150GAR12T4



SEMITRANS®2

Fast IGBT4 Modules

SKM150GAR12T4

Features

- IGBT4 = 4. Generation (Trench)IGBT
- VCEsat with positive temperature coefficient
- High short circuit capability, self limiting to $6 \times I_{CNOM}$
- Soft switching 4. Generation CAL diode (CAL4)

Typical Applications

- DC/DC – converter
- Brake chopper
- Switched reluctance motor
- DC – Motor

Remarks

- Case temperature limited to $T_c = 125^\circ\text{C}$ max, recomm.
Top = $-40 \dots +150^\circ\text{C}$, product rel. results valid for $T_j = 150^\circ$

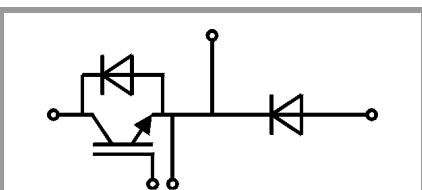

GAR

Absolute Maximum Ratings					
Symbol	Conditions		Values	Unit	
IGBT					
V_{CES}			1200	V	
I_C	$T_j = 175^\circ\text{C}$	$T_c = 25^\circ\text{C}$	232	A	
		$T_c = 80^\circ\text{C}$	179	A	
I_{Cnom}			150	A	
I_{CRM}	$I_{CRM} = 3 \times I_{Cnom}$		450	A	
V_{GES}			-20 ... 20	V	
t_{psc}	$V_{CC} = 800\text{ V}$ $V_{GE} \leq 15\text{ V}$ $V_{CES} \leq 1200\text{ V}$	$T_j = 150^\circ\text{C}$	10		μs
T_j			-40 ... 175	$^\circ\text{C}$	
Inverse diode					
I_F	$T_j = 175^\circ\text{C}$	$T_c = 25^\circ\text{C}$	189	A	
		$T_c = 80^\circ\text{C}$	141	A	
I_{Fnom}			150	A	
I_{FRM}	$I_{FRM} = 3 \times I_{Fnom}$		450	A	
I_{FSM}	$t_p = 10\text{ ms, sin } 180^\circ, T_j = 25^\circ\text{C}$		900	A	
T_j			-40 ... 175	$^\circ\text{C}$	
Freewheeling diode					
I_F	$T_j = 175^\circ\text{C}$	$T_c = 25^\circ\text{C}$	189	A	
		$T_c = 80^\circ\text{C}$	141	A	
I_{Fnom}			150	A	
I_{FRM}	$I_{FRM} = 3 \times I_{Fnom}$		450	A	
I_{FSM}	$t_p = 10\text{ ms, sin } 180^\circ, T_j = 25^\circ\text{C}$		900	A	
T_j			-40 ... 175	$^\circ\text{C}$	
Module					
$I_{t(RMS)}$			200	A	
T_{stg}			-40 ... 125	$^\circ\text{C}$	
V_{isol}	AC sinus 50Hz, $t = 1\text{ min}$		4000	V	

Characteristics						
Symbol	Conditions		min.	typ.	max.	Unit
IGBT						
$V_{CE(sat)}$	$I_C = 150\text{ A}$ $V_{GE} = 15\text{ V}$ chipelevel	$T_j = 25^\circ\text{C}$	1.8	2.05		V
		$T_j = 150^\circ\text{C}$	2.2	2.4		V
V_{CE0}		$T_j = 25^\circ\text{C}$	0.8	0.9		V
		$T_j = 150^\circ\text{C}$	0.7	0.8		V
r_{CE}	$V_{GE} = 15\text{ V}$	$T_j = 25^\circ\text{C}$	6.7	7.7		$\text{m}\Omega$
		$T_j = 150^\circ\text{C}$	10.0	10.7		$\text{m}\Omega$
$V_{GE(th)}$	$V_{GE} = V_{CE}, I_C = 6\text{ mA}$		5	5.8	6.5	V
I_{CES}	$V_{GE} = 0\text{ V}$ $V_{CE} = 1200\text{ V}$	$T_j = 25^\circ\text{C}$	0.1	0.3		mA
		$T_j = 150^\circ\text{C}$				mA
C_{ies}	$V_{CE} = 25\text{ V}$ $V_{GE} = 0\text{ V}$	$f = 1\text{ MHz}$	9.3			nF
C_{oes}		$f = 1\text{ MHz}$	0.58			nF
C_{res}		$f = 1\text{ MHz}$	0.51			nF
Q_G	$V_{GE} = -8\text{ V} \dots +15\text{ V}$		850			nC
R_{Gint}	$T_j = 25^\circ\text{C}$		5.0			Ω

SKM150GAR12T4



SEMITRANS®2

Fast IGBT4 Modules

SKM150GAR12T4

Features

- IGBT4 = 4. Generation (Trench)IGBT
- VCEsat with positive temperature coefficient
- High short circuit capability, self limiting to $6 \times I_{CNOM}$
- Soft switching 4. Generation CAL diode (CAL4)

Typical Applications

- DC/DC – converter
- Brake chopper
- Switched reluctance motor
- DC – Motor

Remarks

- Case temperature limited to $T_c = 125^\circ\text{C}$ max, recomm.
Top = $-40 \dots +150^\circ\text{C}$, product rel. results valid for $T_j = 150^\circ$

Characteristics						
Symbol	Conditions		min.	typ.	max.	Unit
$t_{d(on)}$	$V_{CC} = 600\text{ V}$	$T_j = 150^\circ\text{C}$		180		ns
t_r	$I_C = 150\text{ A}$	$T_j = 150^\circ\text{C}$		42		ns
E_{on}	$V_{GE} = \pm 15\text{ V}$	$T_j = 150^\circ\text{C}$		19.2		mJ
$t_{d(off)}$	$R_{G\ on} = 1\ \Omega$	$T_j = 150^\circ\text{C}$		410		ns
t_f	$R_{G\ off} = 1\ \Omega$	$T_j = 150^\circ\text{C}$		72		ns
E_{off}	$di/dt_{on} = 3400\text{ A}/\mu\text{s}$	$T_j = 150^\circ\text{C}$		15.8		mJ
$R_{th(j-c)}$	per IGBT				0.19	K/W
Inverse diode						
$V_F = V_{EC}$	$I_F = 150\text{ A}$	$T_j = 25^\circ\text{C}$		2.14	2.46	V
	$V_{GE} = 0\text{ V}$	$T_j = 150^\circ\text{C}$		2.07	2.38	V
	chip					
V_{F0}		$T_j = 25^\circ\text{C}$		1.3	1.5	V
		$T_j = 150^\circ\text{C}$		0.9	1.1	V
r_F		$T_j = 25^\circ\text{C}$		5.6	6.4	m Ω
		$T_j = 150^\circ\text{C}$		7.8	8.5	m Ω
I_{RRM}	$I_F = 150\text{ A}$	$T_j = 150^\circ\text{C}$		120		A
Q_{rr}	$di/dt_{off} = 3100\text{ A}/\mu\text{s}$	$T_j = 150^\circ\text{C}$		31.3		μC
E_{rr}	$V_{GE} = \pm 15\text{ V}$	$T_j = 150^\circ\text{C}$		13		mJ
	$V_{CC} = 600\text{ V}$					
$R_{th(j-c)}$	per diode				0.31	K/W
Freewheeling diode						
$V_F = V_{EC}$	$I_F = 150\text{ A}$	$T_j = 25^\circ\text{C}$		2.14	2.46	V
	$V_{GE} = 0\text{ V}$	$T_j = 150^\circ\text{C}$		2.07	2.38	V
	chip					
V_{F0}		$T_j = 25^\circ\text{C}$		1.3	1.5	V
		$T_j = 150^\circ\text{C}$		0.9	1.1	V
r_F		$T_j = 25^\circ\text{C}$		5.6	6.4	m Ω
		$T_j = 150^\circ\text{C}$		7.8	8.5	m Ω
I_{RRM}	$I_F = 150\text{ A}$	$T_j = 150^\circ\text{C}$		120		A
Q_{rr}	$di/dt_{off} = 3100\text{ A}/\mu\text{s}$	$T_j = 150^\circ\text{C}$		31.3		μC
E_{rr}	$V_{GE} = \pm 15\text{ V}$	$T_j = 150^\circ\text{C}$		13		mJ
	$V_{CC} = 600\text{ V}$					
$R_{th(j-c)}$	per Diode				0.31	K/W
Module						
L_{CE}					30	nH
$R_{CC+EE'}$	terminal-chip	$T_C = 25^\circ\text{C}$		0.65		m Ω
		$T_C = 125^\circ\text{C}$		1		m Ω
$R_{th(c-s)}$	per module			0.04	0.05	K/W
M_s	to heat sink M6			3	5	Nm
M_t		to terminals M5		2.5	5	Nm
						Nm
w					160	g

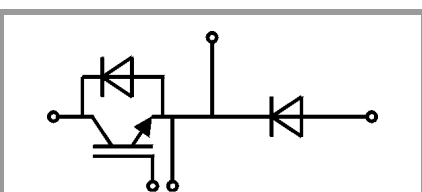

GAR

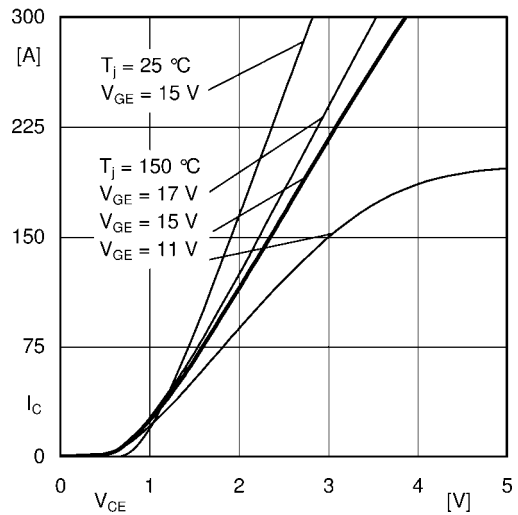

Fig. 1: Typ. output characteristic, inclusive $R_{CC'+EE'}$

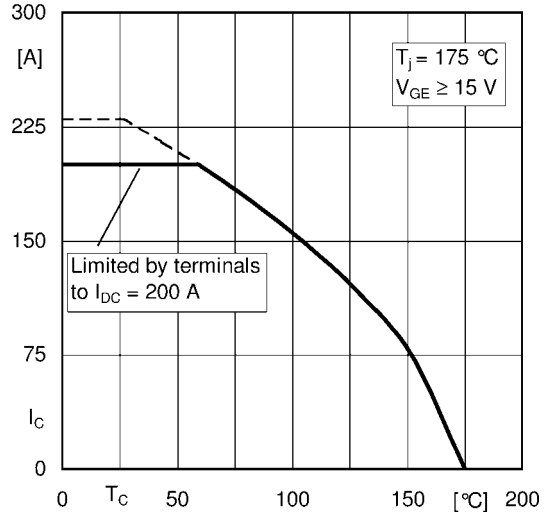

Fig. 2: Rated current vs. temperature $I_C = f(T_C)$

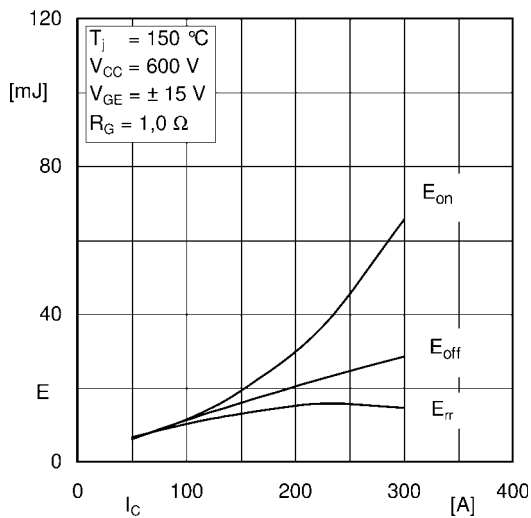

Fig. 3: Typ. turn-on /-off energy = $f(I_C)$

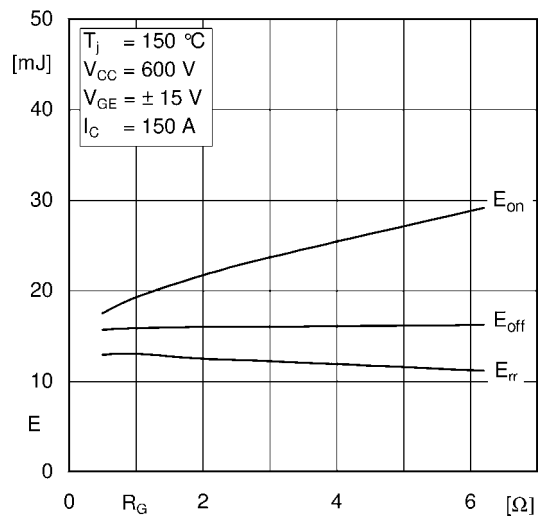

Fig. 4: Typ. turn-on /-off energy = $f(R_G)$

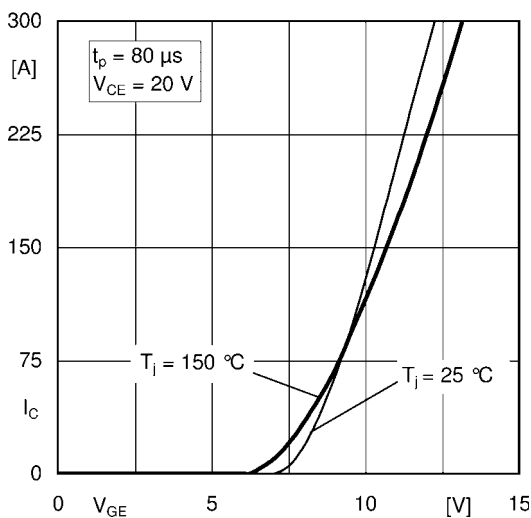

Fig. 5: Typ. transfer characteristic

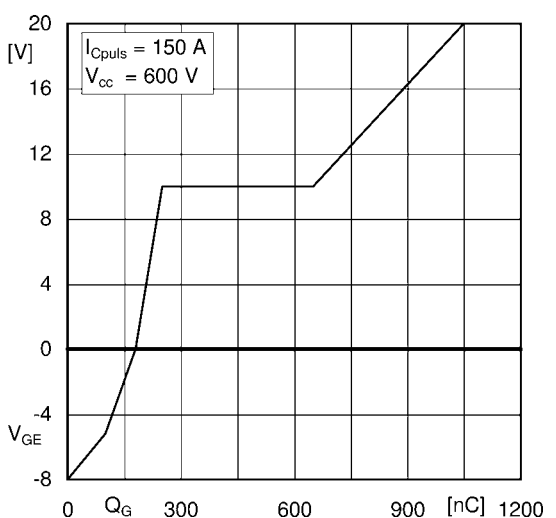

Fig. 6: Typ. gate charge characteristic

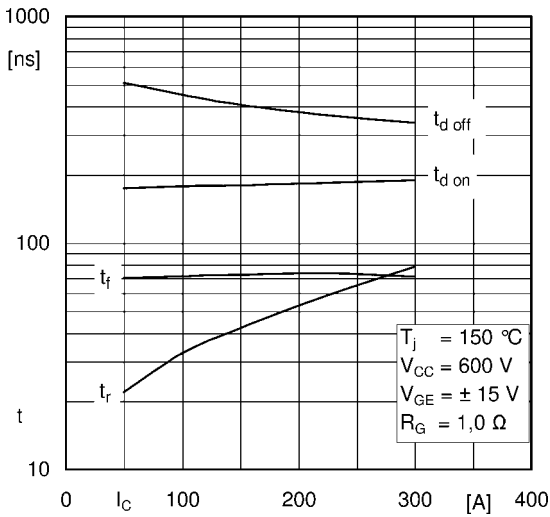

Fig. 7: Typ. switching times vs. I_C

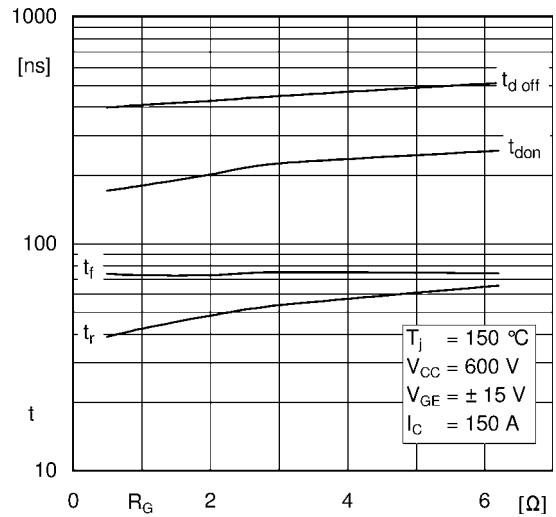

Fig. 8: Typ. switching times vs. gate resistor R_G

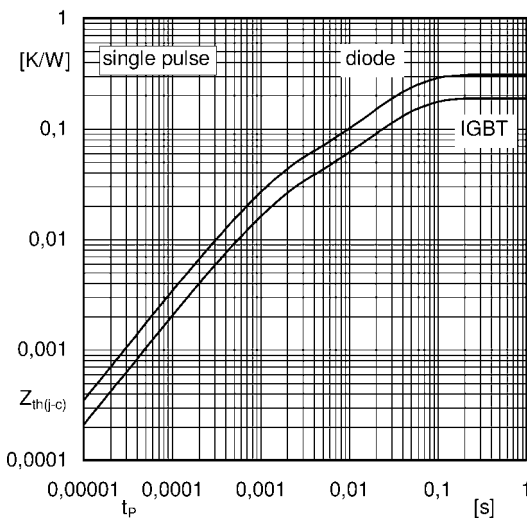

Fig. 9: Transient thermal impedance

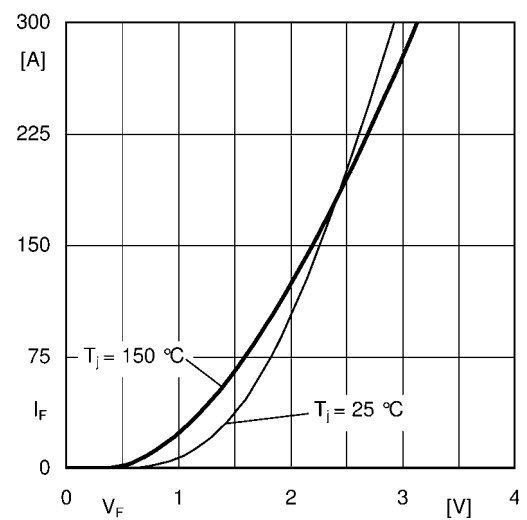

Fig. 10: CAL diode forward characteristic

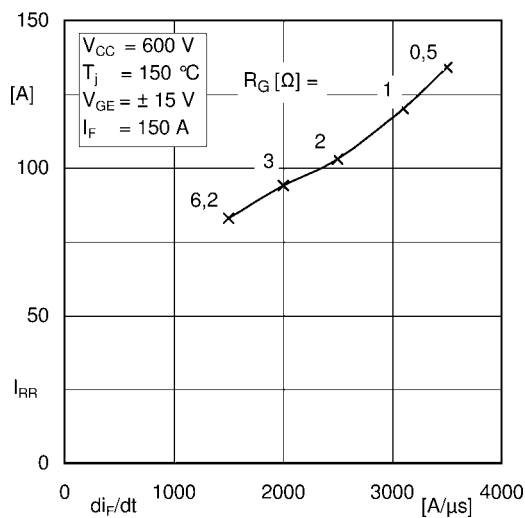

Fig. 11: CAL diode peak reverse recovery current

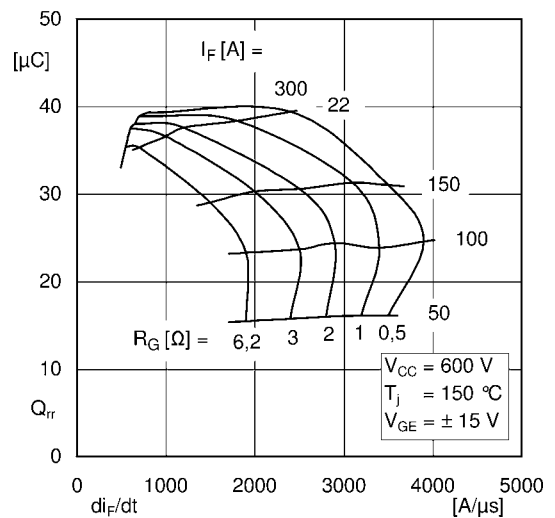
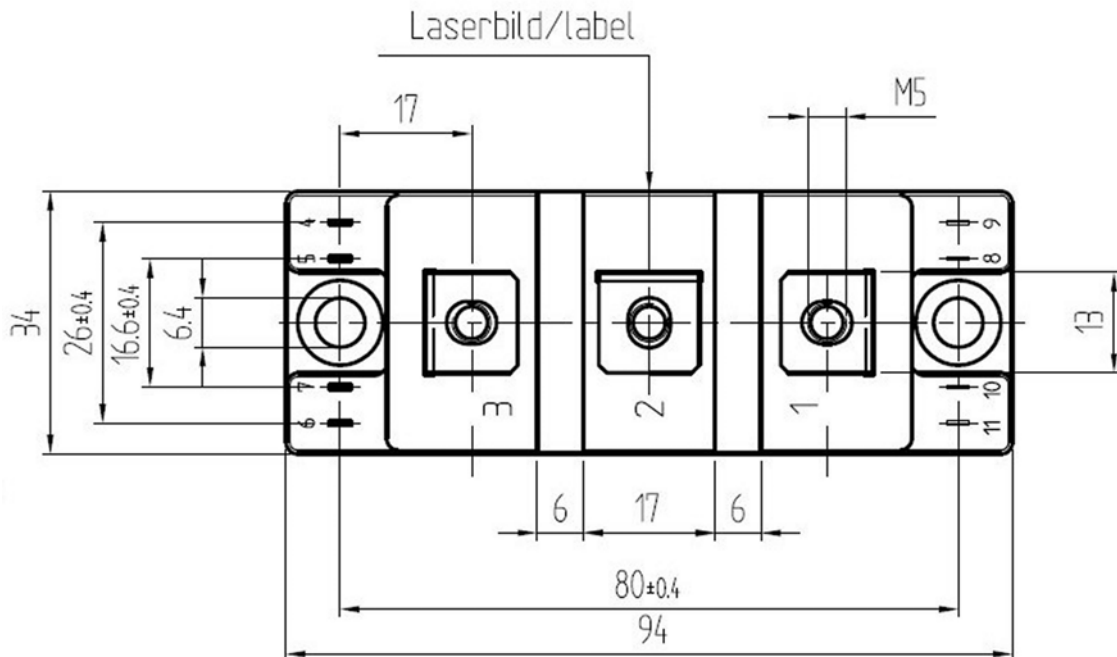
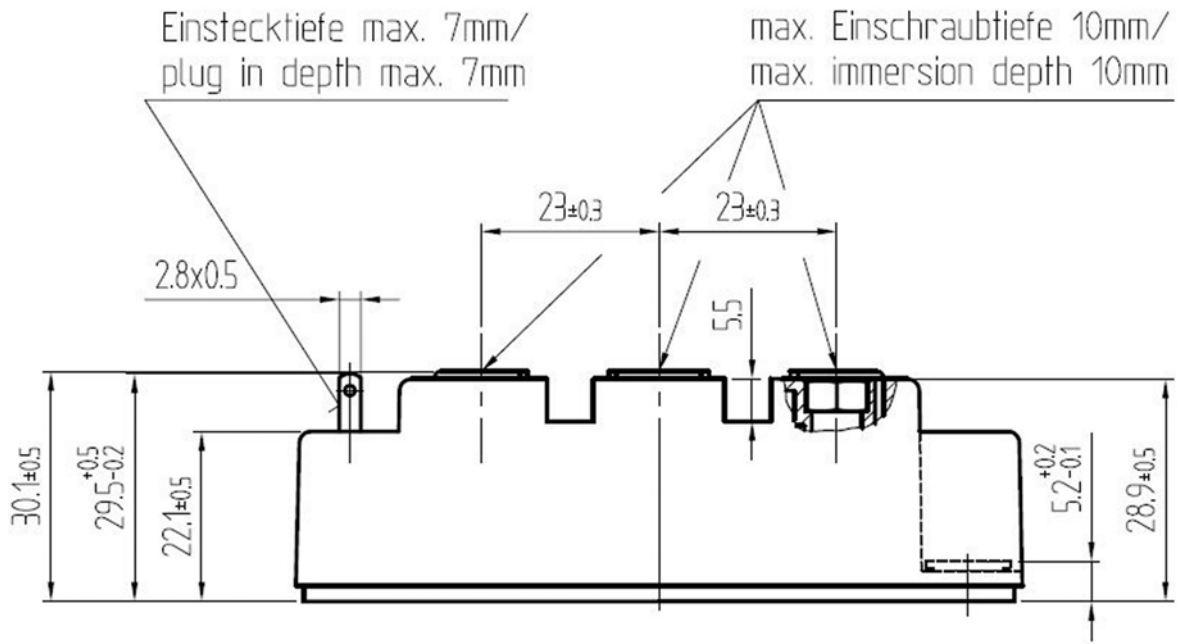
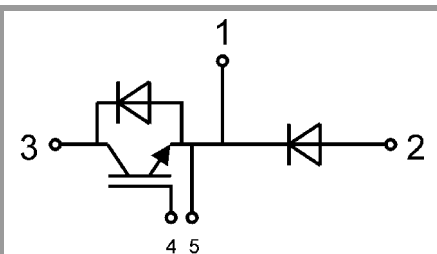

Fig. 12: Typ. CAL diode peak reverse recovery charge

SKM150GAR12T4



Semitrans 2



GAR

This is an electrostatic discharge sensitive device (ESDS), international standard IEC 60747-1, Chapter IX.

This technical information specifies semiconductor devices but promises no characteristics. No warranty or guarantee expressed or implied is made regarding delivery, performance or suitability.