

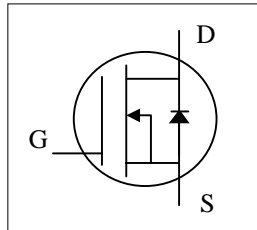

- ▼ Low on-resistance
- ▼ Capable of 2.5V gate drive
- ▼ Low drive current
- ▼ Surface mount package



$BV_{DSS}$	18V
$R_{DS(ON)}$	25m $\Omega$
$I_D$	35A

### Description

The Advanced Power MOSFETs from APEC provide the designer with the best combination of fast switching, ruggedized device design, ultra low on-resistance and cost-effectiveness.

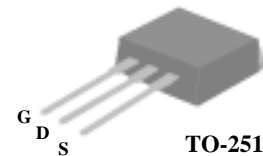

### Absolute Maximum Ratings

Symbol	Parameter	Rating	Units
$V_{DS}$	Drain-Source Voltage	18	V
$V_{GS}$	Gate-Source Voltage	$\pm 8$	V
$I_D @ T_C=25^\circ C$	Continuous Drain Current, $V_{GS} @ 4.5V$	35	A
$I_D @ T_C=125^\circ C$	Continuous Drain Current, $V_{GS} @ 4.5V$	16	A
$I_{DM}$	Pulsed Drain Current <sup>1</sup>	90	A
$P_D @ T_C=25^\circ C$	Total Power Dissipation	50	W
	Linear Derating Factor	0.4	W/ $^\circ C$
$T_{STG}$	Storage Temperature Range	-55 to 150	$^\circ C$
$T_J$	Operating Junction Temperature Range	-55 to 150	$^\circ C$

### Thermal Data

Symbol	Parameter	Value	Unit
Rthj-c	Thermal Resistance Junction-case	Max. 2.5	$^\circ C/W$
Rthj-a	Thermal Resistance Junction-ambient	Max. 110	$^\circ C/W$



**Electrical Characteristics @T<sub>j</sub>=25°C(unless otherwise specified)**

Symbol	Parameter	Test Conditions	Min.	Typ.	Max.	Units
BV <sub>DSS</sub>	Drain-Source Breakdown Voltage	V <sub>GS</sub> =0V, I <sub>D</sub> =250uA	18	-	-	V
ΔBV <sub>DSS</sub> /ΔT <sub>j</sub>	Breakdown Voltage Temperature Coefficient	Reference to 25°C, I <sub>D</sub> =1mA	-	0.03	-	V/°C
R <sub>DS(ON)</sub>	Static Drain-Source On-Resistance	V <sub>GS</sub> =4.5V, I <sub>D</sub> =6A	-	-	25	mΩ
		V <sub>GS</sub> =2.5V, I <sub>D</sub> =5.2A	-	-	40	mΩ
V <sub>GS(th)</sub>	Gate Threshold Voltage	V <sub>DS</sub> =V <sub>GS</sub> , I <sub>D</sub> =250uA	0.5	-	1	V
g <sub>fs</sub>	Forward Transconductance	V <sub>DS</sub> =10V, I <sub>D</sub> =6A	-	18	-	S
I <sub>DSS</sub>	Drain-Source Leakage Current (T <sub>j</sub> =25°C)	V <sub>DS</sub> =18V, V <sub>GS</sub> =0V	-	-	25	uA
	Drain-Source Leakage Current (T <sub>j</sub> =125°C)	V <sub>DS</sub> =18V, V <sub>GS</sub> =0V	-	-	250	uA
I <sub>GSS</sub>	Gate-Source Leakage	V <sub>GS</sub> = ± 8V	-	-	±100	nA
Q <sub>g</sub>	Total Gate Charge <sup>2</sup>	I <sub>D</sub> =18A	-	17.5	-	nC
Q <sub>gs</sub>	Gate-Source Charge	V <sub>DS</sub> =18V	-	1.2	-	nC
Q <sub>gd</sub>	Gate-Drain ("Miller") Charge	V <sub>GS</sub> =5V	-	7.9	-	nC
t <sub>d(on)</sub>	Turn-on Delay Time <sup>2</sup>	V <sub>DS</sub> =10V	-	7.3	-	ns
t <sub>r</sub>	Rise Time	I <sub>D</sub> =18A	-	98	-	ns
t <sub>d(off)</sub>	Turn-off Delay Time	R <sub>G</sub> =3.3Ω, V <sub>GS</sub> =5V	-	25.6	-	ns
t <sub>f</sub>	Fall Time	R <sub>D</sub> =0.56Ω	-	98	-	ns
C <sub>ISS</sub>	Input Capacitance	V <sub>GS</sub> =0V	-	527	-	pF
C <sub>OSS</sub>	Output Capacitance	V <sub>DS</sub> =18V	-	258	-	pF
C <sub>rSS</sub>	Reverse Transfer Capacitance	f=1.0MHz	-	112	-	pF

**Source-Drain Diode**

Symbol	Parameter	Test Conditions	Min.	Typ.	Max.	Units
I <sub>S</sub>	Continuous Source Current ( Body Diode )	V <sub>D</sub> =V <sub>G</sub> =0V , V <sub>S</sub> =1.3V	-	-	35	A
I <sub>SM</sub>	Pulsed Source Current ( Body Diode ) <sup>1</sup>		-	-	90	A
V <sub>SD</sub>	Forward On Voltage <sup>2</sup>	T <sub>j</sub> =25°C, I <sub>S</sub> =35A, V <sub>GS</sub> =0V	-	-	1.3	V

**Notes:**

- 1.Pulse width limited by safe operating area.
- 2.Pulse width ≤300us , duty cycle ≤2%.

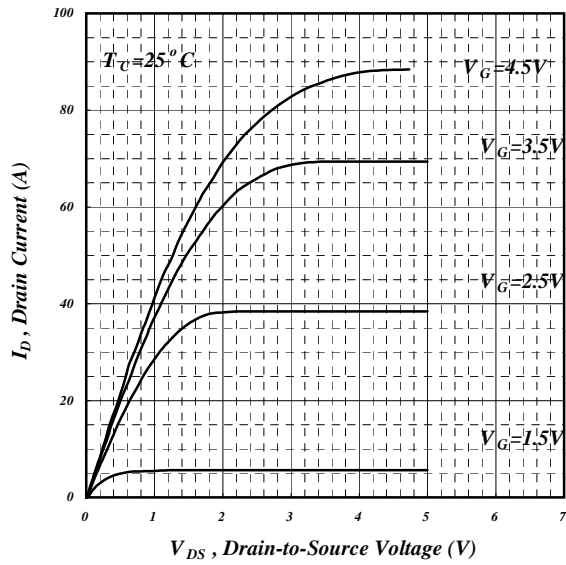

Fig 1. Typical Output Characteristics

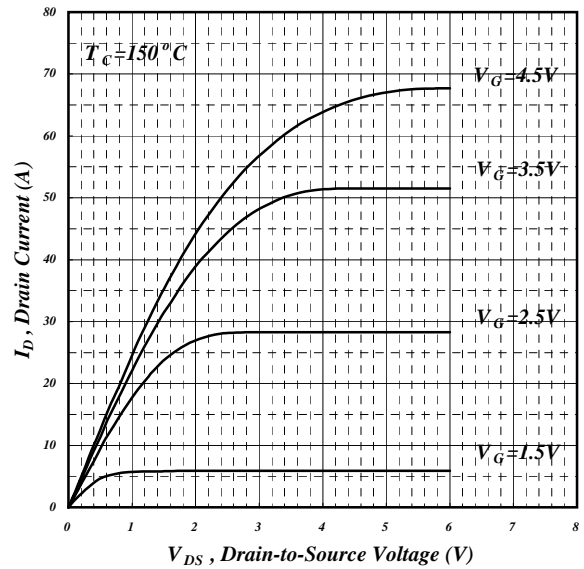
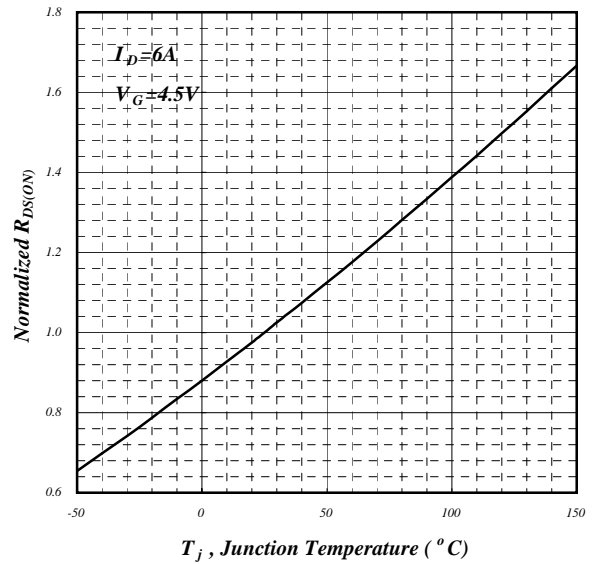
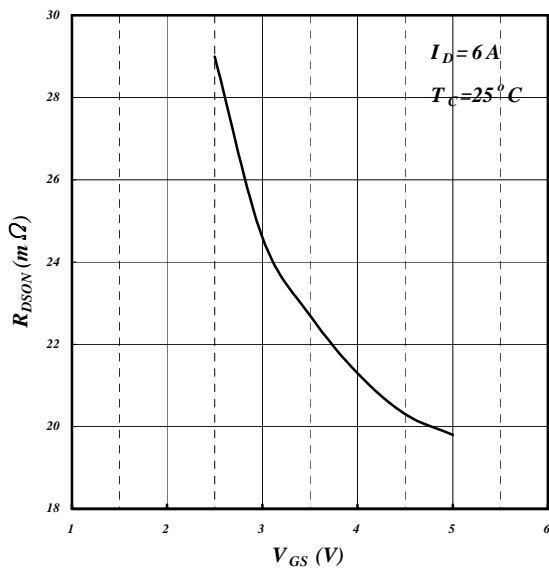

Fig 2. Typical Output Characteristics



v.s. Junction Temperature

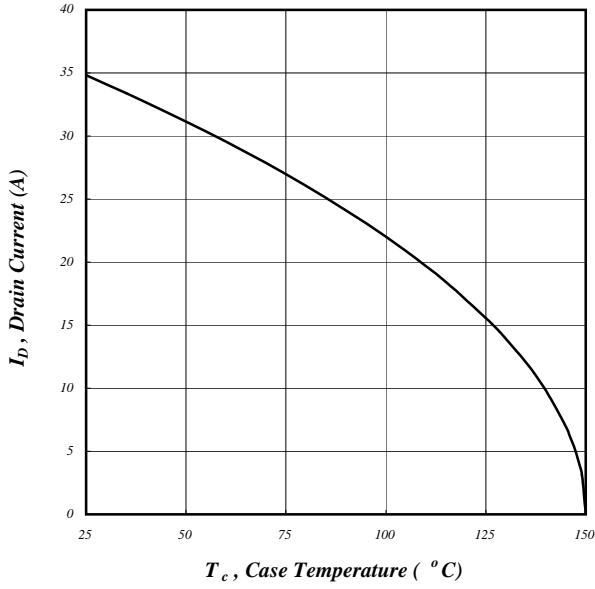

Fig 5. Maximum Drain Current v.s. Case Temperature

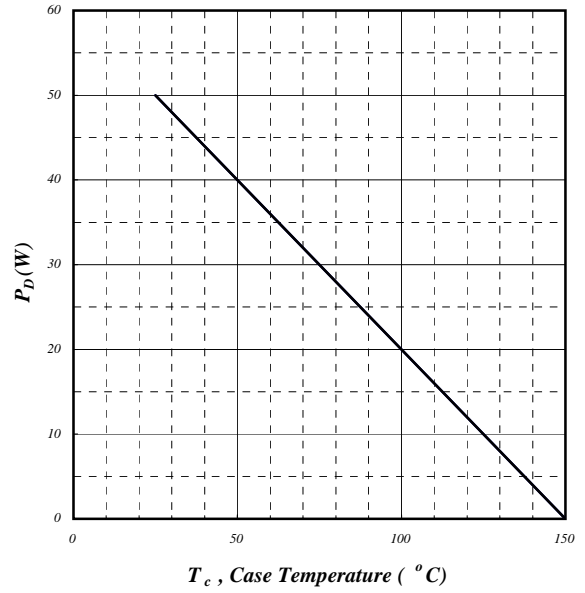
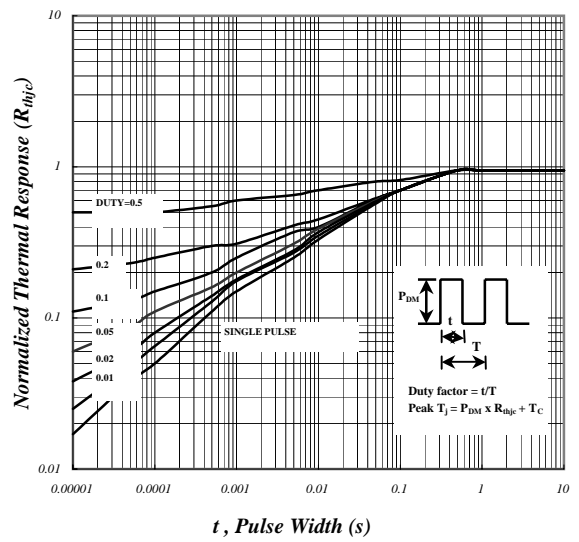
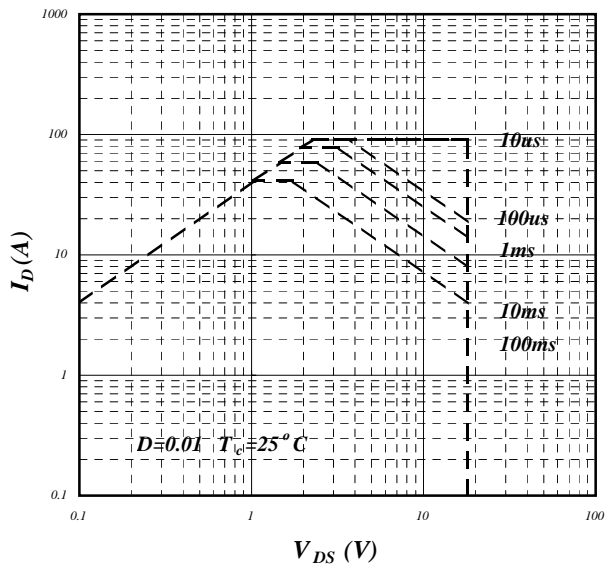

Fig 6. Typical Power Dissipation



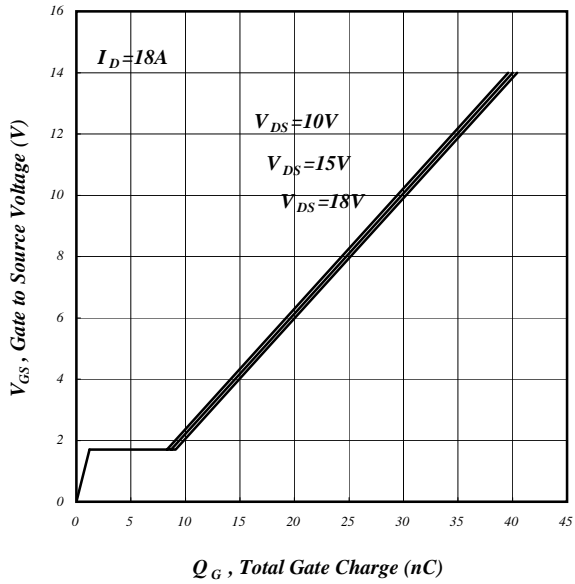

Fig 9. Gate Charge Characteristics

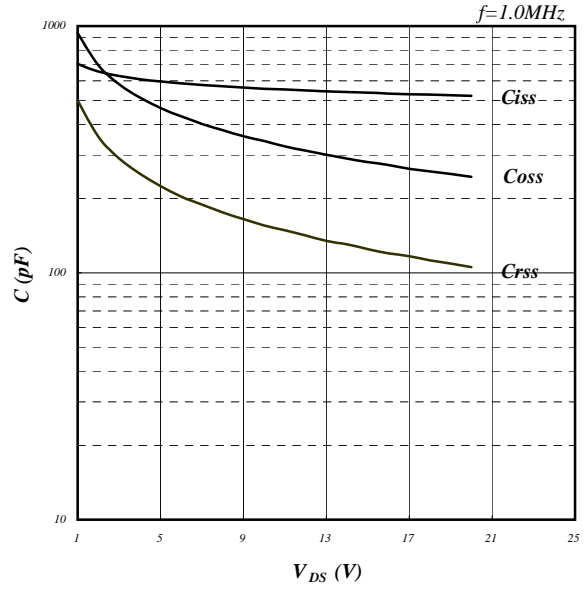
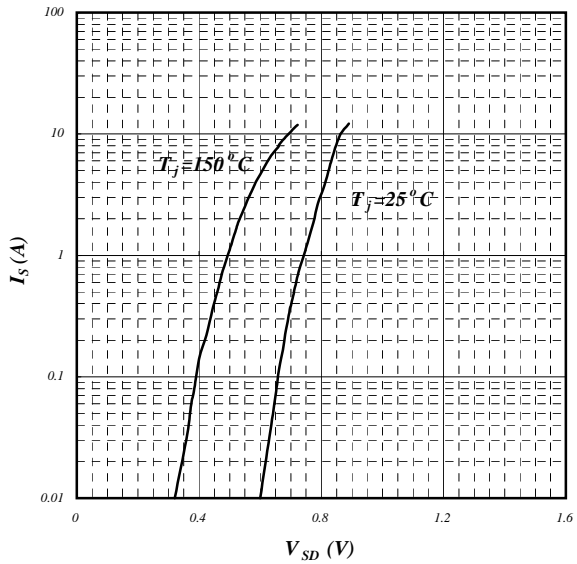
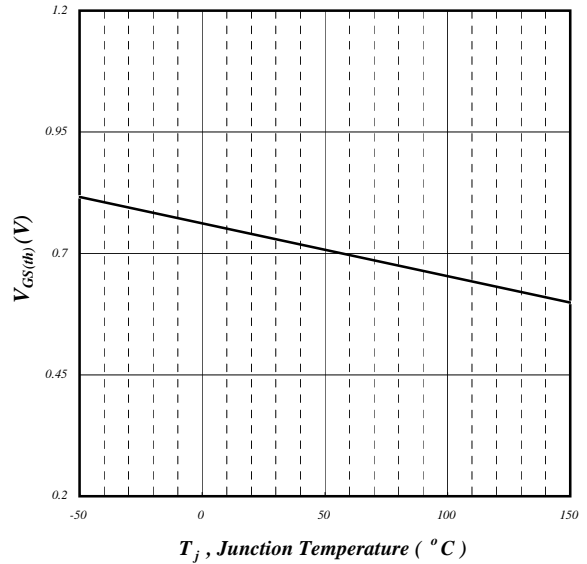

Fig 10. Typical Capacitance Characteristics



Reverse Diode



Junction Temperature

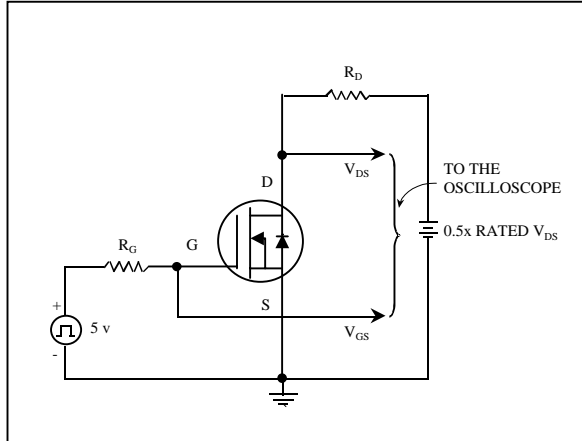

Fig 13. Switching Time Circuit

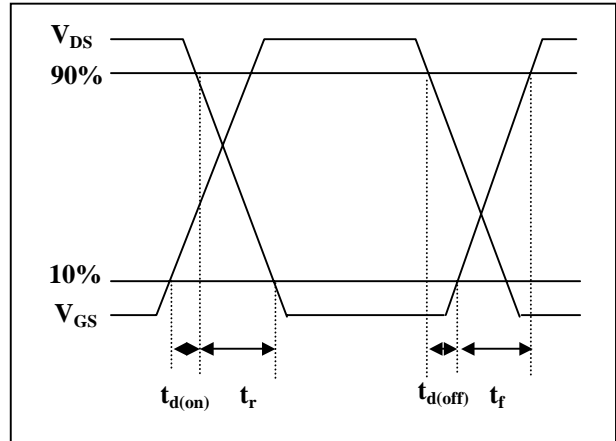

Fig 14. Switching Time Waveform

