

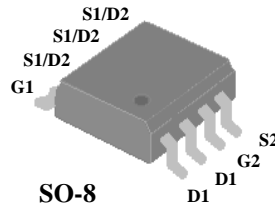

- ▼ Low On-resistance
- ▼ Fast Switching Characteristic
- ▼ Surface Mount Package
- ▼ RoHS Compliant & Halogen-Free



| | | |
|------|--------------|----------------|
| CH-1 | BV_{DSS} | 30V |
| | $R_{DS(ON)}$ | 15.8m Ω |
| | I_D | 9A |
| CH-2 | BV_{DSS} | 30V |
| | $R_{DS(ON)}$ | 15.8m Ω |
| | I_D | 9A |

Description

Advanced Power MOSFETs from APEC provide the designer with the best combination of fast switching, ruggedized device design, ultra low on-resistance and cost-effectiveness.

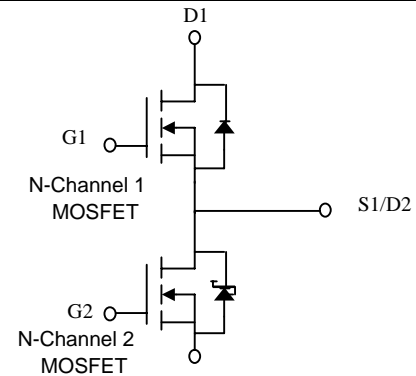

Absolute Maximum Ratings

| Symbol | Parameter | Rating | | Units |
|--------------------------|---------------------------------------|------------|----------|------------|
| | | CH-1 | CH2 | |
| V_{DS} | Drain-Source Voltage | 30 | 30 | V |
| V_{GS} | Gate-Source Voltage | ± 20 | ± 20 | V |
| $I_D @ T_A = 25^\circ C$ | Continuous Drain Current ³ | 9 | 9 | A |
| $I_D @ T_A = 70^\circ C$ | Continuous Drain Current ³ | 7.2 | 7.2 | A |
| I_{DM} | Pulsed Drain Current ¹ | 40 | 40 | A |
| $P_D @ T_A = 25^\circ C$ | Total Power Dissipation | 2.0 | | W |
| T_{STG} | Storage Temperature Range | -55 to 150 | | $^\circ C$ |
| T_J | Operating Junction Temperature Range | -55 to 150 | | $^\circ C$ |

Thermal Data

| Symbol | Parameter | Value | Unit |
|-------------|---|-------|--------------|
| R_{thj-a} | Maximum Thermal Resistance, Junction-ambient ³ | 62.5 | $^\circ C/W$ |



AP6910GSM-HF

CH-1 Electrical Characteristics @T_j=25°C(unless otherwise specified)

| Symbol | Parameter | Test Conditions | Min. | Typ. | Max. | Units |
|---------------------|--|--|------|------|------|-------|
| B _V DSS | Drain-Source Breakdown Voltage | V _{GS} =0V, I _D =250uA | 30 | - | - | V |
| R _{DS(ON)} | Static Drain-Source On-Resistance ² | V _{GS} =10V, I _D =9A | - | - | 15.8 | mΩ |
| | | V _{GS} =4.5V, I _D =6A | - | - | 23 | mΩ |
| V _{GS(th)} | Gate Threshold Voltage | V _{DS} =V _{GS} , I _D =250uA | 1 | - | 3 | V |
| g _{fs} | Forward Transconductance | V _{DS} =5V, I _D =9A | - | 16 | - | S |
| I _{DSS} | Drain-Source Leakage Current | V _{DS} =30V, V _{GS} =0V | - | - | 1 | uA |
| I _{GSS} | Gate-Source Leakage | V _{GS} =±20V, V _{DS} =0V | - | - | ±100 | nA |
| Q _g | Total Gate Charge ² | I _D =9A | - | 6 | 9.6 | nC |
| Q _{gs} | Gate-Source Charge | V _{DS} =15V | - | 1.4 | - | nC |
| Q _{gd} | Gate-Drain ("Miller") Charge | V _{GS} =4.5V | - | 3.4 | - | nC |
| t _{d(on)} | Turn-on Delay Time ² | V _{DS} =15V | - | 6 | - | ns |
| t _r | Rise Time | I _D =9A | - | 30 | - | ns |
| t _{d(off)} | Turn-off Delay Time | R _G =3Ω, V _{GS} =10V | - | 16 | - | ns |
| t _f | Fall Time | R _D =1.7Ω | - | 5 | - | ns |
| C _{iss} | Input Capacitance | V _{GS} =0V | - | 400 | 640 | pF |
| C _{oss} | Output Capacitance | V _{DS} =25V | - | 135 | - | pF |
| C _{rss} | Reverse Transfer Capacitance | f=1.0MHz | - | 80 | - | pF |
| R _g | Gate Resistance | f=1.0MHz | - | 3.5 | 5.3 | Ω |

Source-Drain Diode

| Symbol | Parameter | Test Conditions | Min. | Typ. | Max. | Units |
|-----------------|------------------------------------|---|------|------|------|-------|
| V _{SD} | Forward On Voltage ² | I _S =1A, V _{GS} =0V | - | - | 1 | V |
| t _{rr} | Reverse Recovery Time ² | I _S =9A, V _{GS} =0V | - | 20 | - | ns |
| Q _{rr} | Reverse Recovery Charge | dI/dt=100A/μs | - | 13 | - | nC |

**CH-2 Electrical Characteristics @T_j=25°C(unless otherwise specified)**

| Symbol | Parameter | Test Conditions | Min. | Typ. | Max. | Units |
|---------------------|--|--|------|------|------|-------|
| BV _{DSS} | Drain-Source Breakdown Voltage | V _{GS} =0V, I _D =250uA | 30 | - | - | V |
| R _{DS(ON)} | Static Drain-Source On-Resistance ² | V _{GS} =10V, I _D =9A | - | - | 15.8 | mΩ |
| | | V _{GS} =4.5V, I _D =6A | - | - | 25.2 | mΩ |
| V _{GS(th)} | Gate Threshold Voltage | V _{DS} =V _{GS} , I _D =250uA | 1 | - | 3 | V |
| g _{fs} | Forward Transconductance | V _{DS} =5V, I _D =9A | - | 16 | - | S |
| I _{DSS} | Drain-Source Leakage Current | V _{DS} =30V, V _{GS} =0V | - | - | 100 | uA |
| I _{GSS} | Gate-Source Leakage | V _{GS} =±20V, V _{DS} =0V | - | - | ±100 | nA |
| Q _g | Total Gate Charge ² | I _D =9A | - | 6 | 9.6 | nC |
| Q _{gs} | Gate-Source Charge | V _{DS} =15V | - | 1.2 | - | nC |
| Q _{gd} | Gate-Drain ("Miller") Charge | V _{GS} =4.5V | - | 3.4 | - | nC |
| t _{d(on)} | Turn-on Delay Time ² | V _{DS} =15V | - | 6 | - | ns |
| t _r | Rise Time | I _D =9A | - | 28 | - | ns |
| t _{d(off)} | Turn-off Delay Time | R _G =3Ω, V _{GS} =10V | - | 16 | - | ns |
| t _f | Fall Time | R _D =1.7Ω | - | 5 | - | ns |
| C _{iss} | Input Capacitance | V _{GS} =0V | - | 430 | 700 | pF |
| C _{oss} | Output Capacitance | V _{DS} =25V | - | 325 | - | pF |
| C _{rss} | Reverse Transfer Capacitance | f=1.0MHz | - | 120 | - | pF |
| R _g | Gate Resistance | f=1.0MHz | - | 3 | 4.5 | Ω |

Source-Drain Diode

| Symbol | Parameter | Test Conditions | Min. | Typ. | Max. | Units |
|-----------------|------------------------------------|---|------|------|------|-------|
| V _{SD} | Forward On Voltage ² | I _S =1A, V _{GS} =0V | - | - | 0.6 | V |
| t _{rr} | Reverse Recovery Time ² | I _S =9A, V _{GS} =0V | - | 22 | - | ns |
| Q _{rr} | Reverse Recovery Charge | dI/dt=100A/μs | - | 13 | - | nC |

Notes:

- 1.Pulse width limited by Max. junction temperature.
- 2.Pulse test
- 3.Surface mounted on 1 in² copper pad of FR4 board , t ≤10sec ; 135°C/W when mounted on min. copper pad.

THIS PRODUCT IS SENSITIVE TO ELECTROSTATIC DISCHARGE, PLEASE HANDLE WITH CAUTION.

USE OF THIS PRODUCT AS A CRITICAL COMPONENT IN LIFE SUPPORT OR OTHER SIMILAR SYSTEMS IS NOT AUTHORIZED.

APEC DOES NOT ASSUME ANY LIABILITY ARISING OUT OF THE APPLICATION OR USE OF ANY PRODUCT OR CIRCUIT DESCRIBED HEREIN; NEITHER DOES IT CONVEY ANY LICENSE UNDER ITS PATENT RIGHTS, NOR THE RIGHTS OF OTHERS.

APEC RESERVES THE RIGHT TO MAKE CHANGES WITHOUT FURTHER NOTICE TO ANY PRODUCTS HEREIN TO IMPROVE RELIABILITY, FUNCTION OR DESIGN.



AP6910GSM-HF

Channel-1

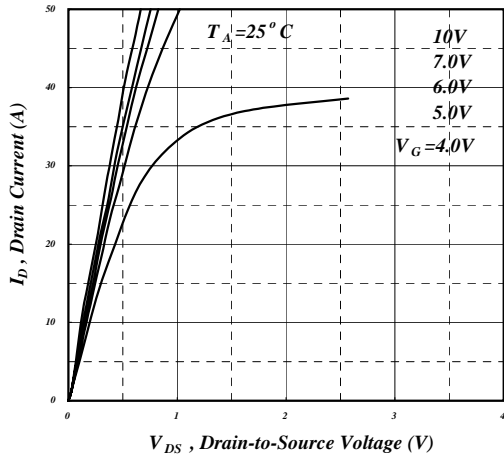

Fig 1. Typical Output Characteristics

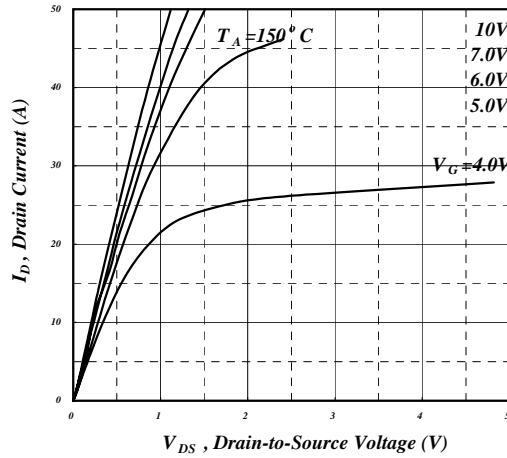

Fig 2. Typical Output Characteristics

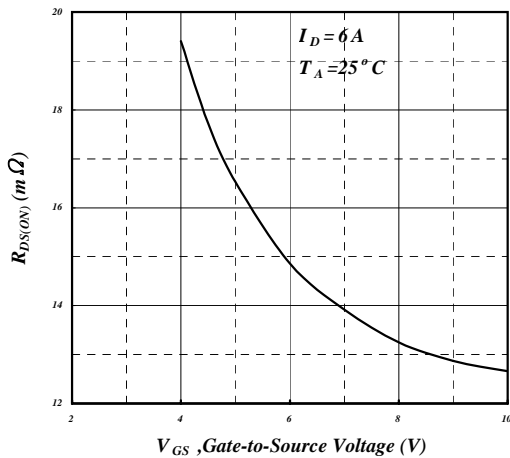

Fig 3. On-Resistance v.s. Gate Voltage

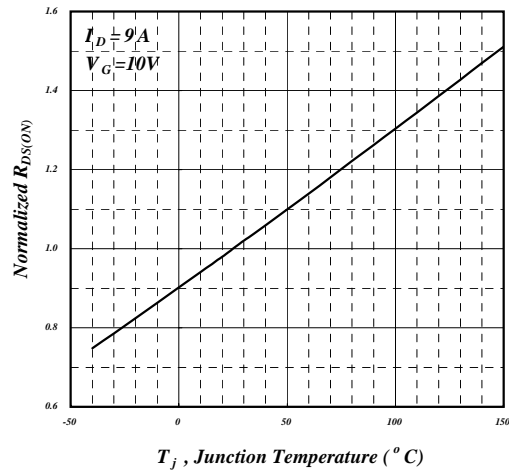

Fig 4. Normalized On-Resistance v.s. Junction Temperature

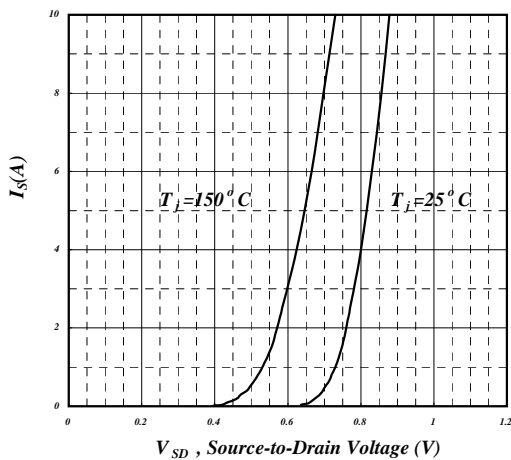

Fig 5. Forward Characteristic of Reverse Diode

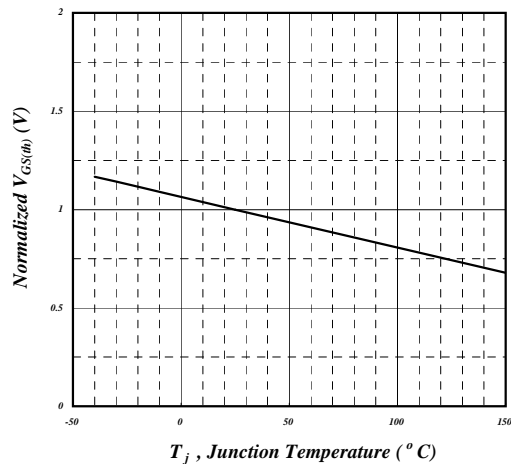

Fig 6. Gate Threshold Voltage v.s. Junction Temperature



Channel-1

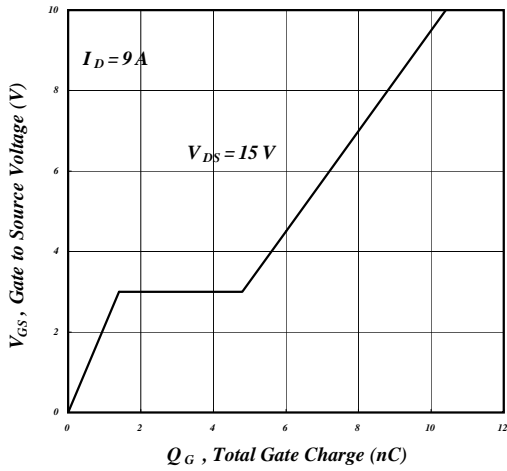

Fig 7. Gate Charge Characteristics

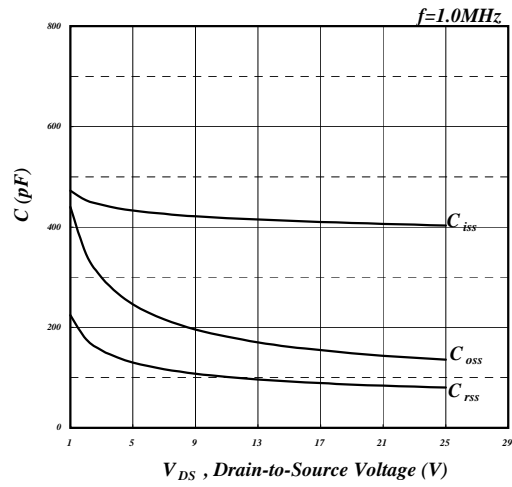

Fig 8. Typical Capacitance Characteristics

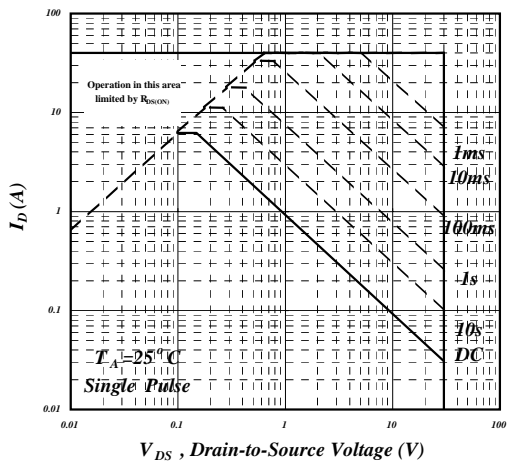

Fig 9. Maximum Safe Operating Area

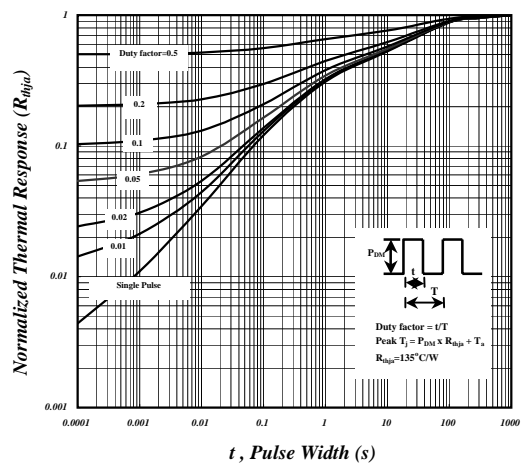

Fig 10. Effective Transient Thermal Impedance

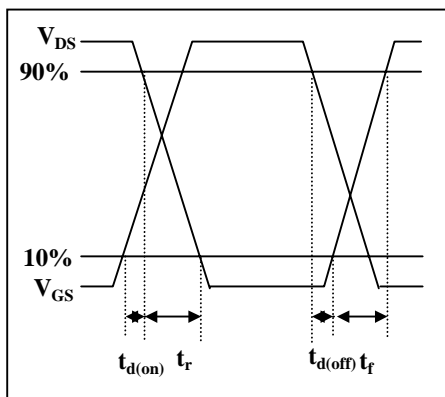

Fig 11. Switching Time Waveform

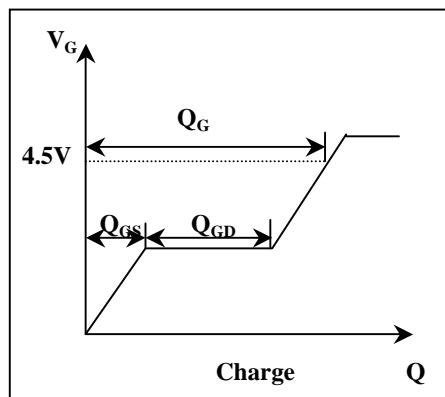

Fig 12. Gate Charge Waveform



Channel-2

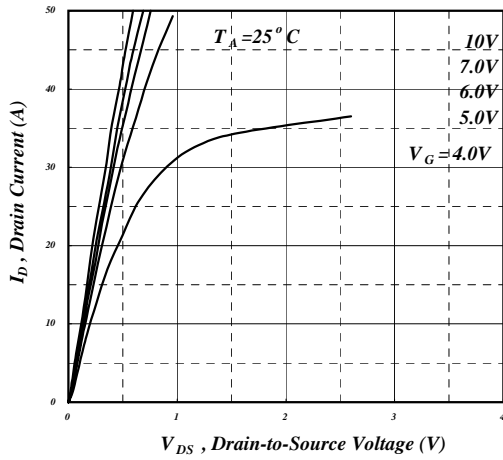

Fig 1. Typical Output Characteristics

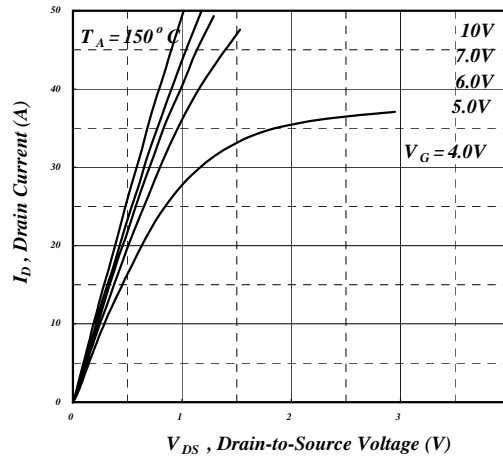

Fig 2. Typical Output Characteristics

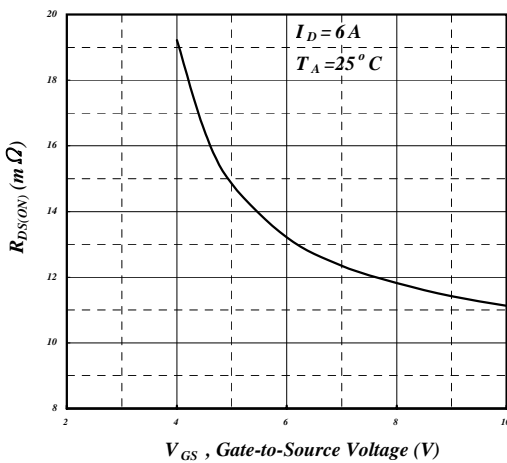

Fig 3. On-Resistance v.s. Gate Voltage

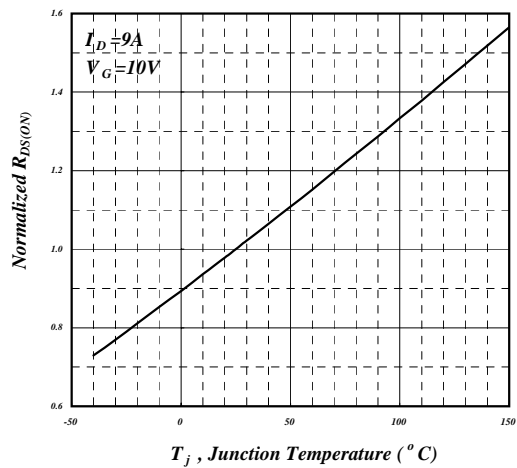

Fig 4. Normalized On-Resistance v.s. Junction Temperature

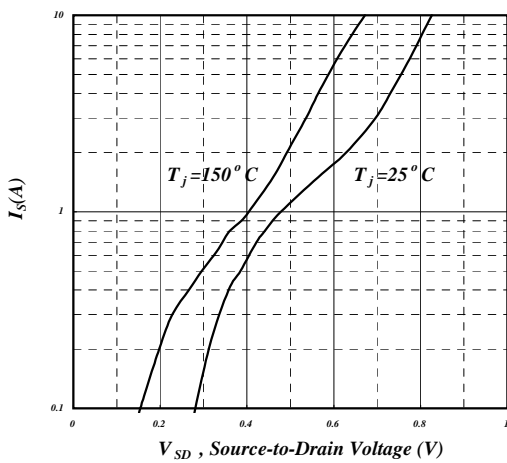

Fig 5. Forward Characteristic of Reverse Diode

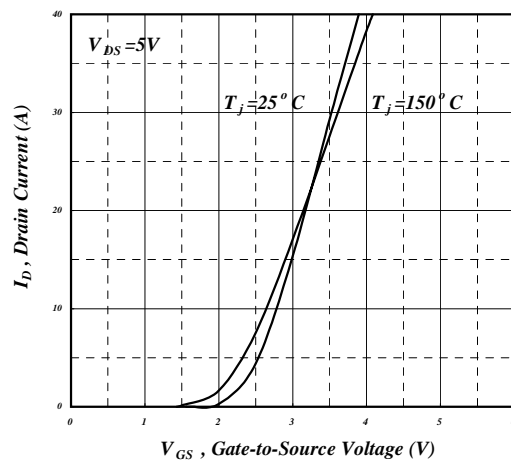

Fig 6. Transfer Characteristics



Channel-2

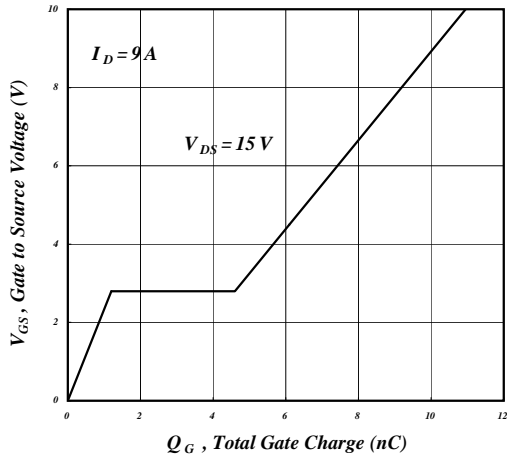

Fig 7. Gate Charge Characteristics

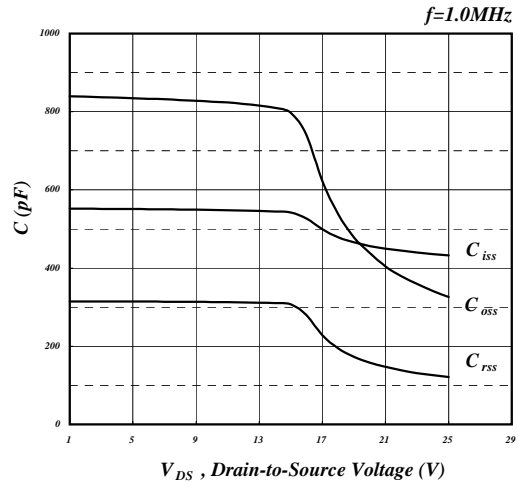

Fig 8. Typical Capacitance Characteristics

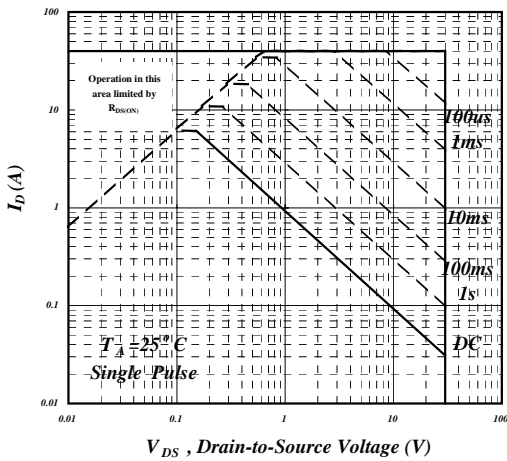

Fig 9. Maximum Safe Operating Area

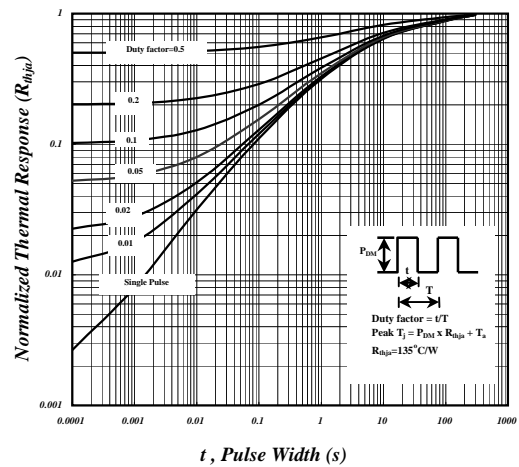

Fig 10. Effective Transient Thermal Impedance

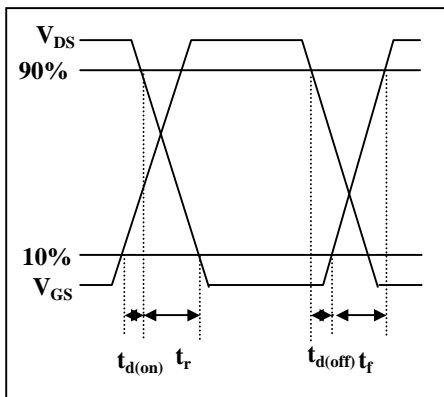

Fig 11. Switching Time Waveform

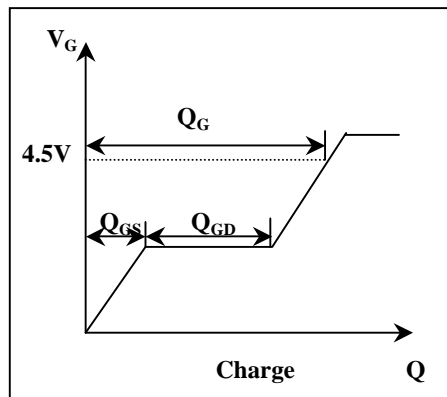

Fig 12. Gate Charge Waveform