

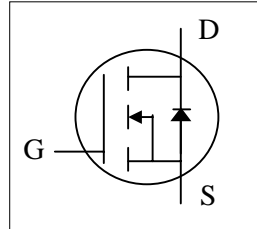

- ▼ Low Gate Charge
- ▼ Simple Drive Requirement
- ▼ Fast Switching



BV_{DSS}	30V
$R_{DS(ON)}$	80m Ω
I_D	15A

Description

TO-252 package is widely preferred for all commercial-industrial surface mount applications and suited for low voltage applications such as DC/DC converters. The through-hole version (AP15N03GJ) is available for low-profile applications.

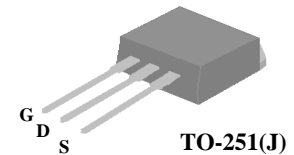
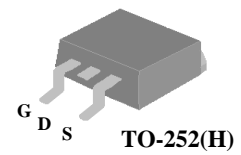

Absolute Maximum Ratings

Symbol	Parameter	Rating	Units
V_{DS}	Drain-Source Voltage	30	V
V_{GS}	Gate-Source Voltage	± 20	V
$I_D @ T_C = 25^\circ C$	Continuous Drain Current, $V_{GS} @ 10V$	15	A
$I_D @ T_C = 100^\circ C$	Continuous Drain Current, $V_{GS} @ 10V$	9	A
I_{DM}	Pulsed Drain Current ¹	50	A
$P_D @ T_C = 25^\circ C$	Total Power Dissipation	26	W
	Linear Derating Factor	0.21	W/ $^\circ C$
T_{STG}	Storage Temperature Range	-55 to 150	$^\circ C$
T_J	Operating Junction Temperature Range	-55 to 150	$^\circ C$

Thermal Data

Symbol	Parameter	Value	Unit
R_{thj-c}	Maximum Thermal Resistance, Junction-case	4.8	$^\circ C/W$
R_{thj-a}	Maximum Thermal Resistance, Junction-ambient (PCB mount) ³	62.5	$^\circ C/W$
R_{thj-a}	Maximum Thermal Resistance, Junction-ambient	110	$^\circ C/W$



AP15N03GH/J

Electrical Characteristics @T_j=25°C (unless otherwise specified)

Symbol	Parameter	Test Conditions	Min.	Typ.	Max.	Units
BV _{DSS}	Drain-Source Breakdown Voltage	V _{GS} =0V, I _D =250uA	30	-	-	V
ΔBV _{DSS} /ΔT _j	Breakdown Voltage Temperature Coefficient	Reference to 25°C, I _D =1mA	-	0.037	-	V/°C
R _{DS(ON)}	Static Drain-Source On-Resistance ²	V _{GS} =10V, I _D =8A	-	-	80	mΩ
		V _{GS} =4.5V, I _D =6A	-	-	100	mΩ
V _{GS(th)}	Gate Threshold Voltage	V _{DS} =V _{GS} , I _D =250uA	1	-	3	V
g _{fs}	Forward Transconductance	V _{DS} =10V, I _D =8A	-	7	-	S
I _{DSS}	Drain-Source Leakage Current	V _{DS} =30V, V _{GS} =0V	-	-	1	uA
	Drain-Source Leakage Current (T _j =150°C)	V _{DS} =24V, V _{GS} =0V	-	-	25	uA
I _{GSS}	Gate-Source Leakage	V _{GS} =±20V	-	-	±100	nA
Q _g	Total Gate Charge ²	I _D =8A	-	4.6	-	nC
Q _{gs}	Gate-Source Charge	V _{DS} =24V	-	1.1	-	nC
Q _{gd}	Gate-Drain ("Miller") Charge	V _{GS} =5V	-	3	-	nC
t _{d(on)}	Turn-on Delay Time ²	V _{DS} =15V	-	4.9	-	ns
t _r	Rise Time	I _D =8A	-	22.5	-	ns
t _{d(off)}	Turn-off Delay Time	R _G =3.4Ω, V _{GS} =10V	-	12.2	-	ns
t _f	Fall Time	R _D =1.9Ω	-	3.3	-	ns
C _{iss}	Input Capacitance	V _{GS} =0V	-	160	-	pF
C _{oss}	Output Capacitance	V _{DS} =25V	-	107	-	pF
C _{riss}	Reverse Transfer Capacitance	f=1.0MHz	-	32	-	pF

Source-Drain Diode

Symbol	Parameter	Test Conditions	Min.	Typ.	Max.	Units
I _S	Continuous Source Current (Body Diode)	V _D =V _G =0V, V _S =1.3V	-	-	15	A
I _{SM}	Pulsed Source Current (Body Diode) ¹		-	-	50	A
V _{SD}	Forward On Voltage ²	I _S =15A, V _{GS} =0V	-	-	1.3	V

Notes:

1. Pulse width limited by Maximum junction temperature.
2. Pulse test
3. Surface mounted on 1 in² copper pad of FR4 board

THIS PRODUCT IS SENSITIVE TO ELECTROSTATIC DISCHARGE, PLEASE HANDLE WITH CAUTION.

USE OF THIS PRODUCT AS A CRITICAL COMPONENT IN LIFE SUPPORT OR OTHER SIMILAR SYSTEMS IS NOT AUTHORIZED.

APEC DOES NOT ASSUME ANY LIABILITY ARISING OUT OF THE APPLICATION OR USE OF ANY PRODUCT OR CIRCUIT DESCRIBED HEREIN; NEITHER DOES IT CONVEY ANY LICENSE UNDER ITS PATENT RIGHTS, NOR THE RIGHTS OF OTHERS.

APEC RESERVES THE RIGHT TO MAKE CHANGES WITHOUT FURTHER NOTICE TO ANY PRODUCTS HEREIN TO IMPROVE RELIABILITY, FUNCTION OR DESIGN.

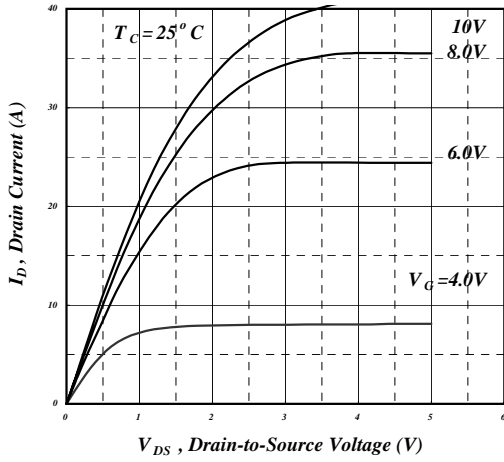

Fig 1. Typical Output Characteristics

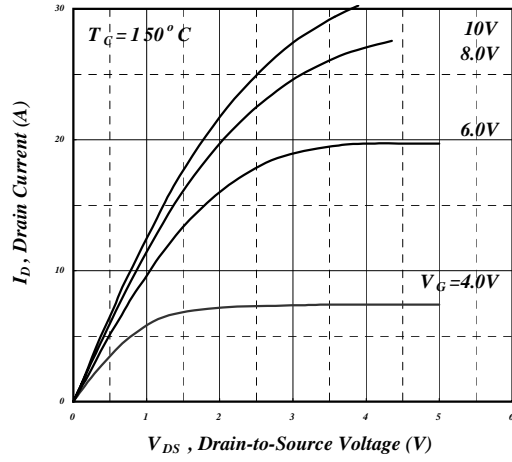

Fig 2. Typical Output Characteristics

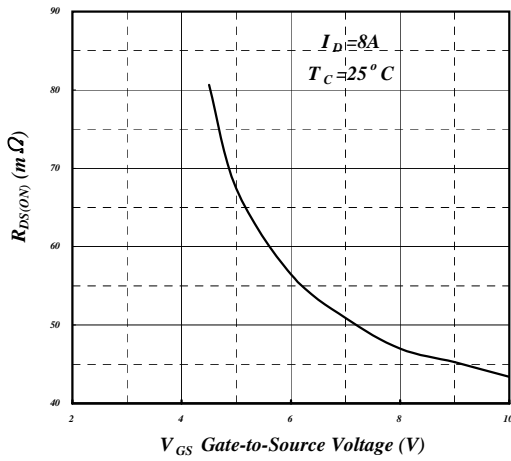

Fig 3. On-Resistance v.s. Gate Voltage

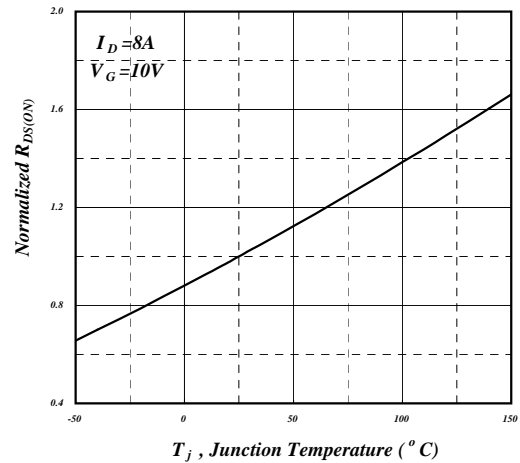

Fig 4. Normalized On-Resistance v.s. Junction Temperature

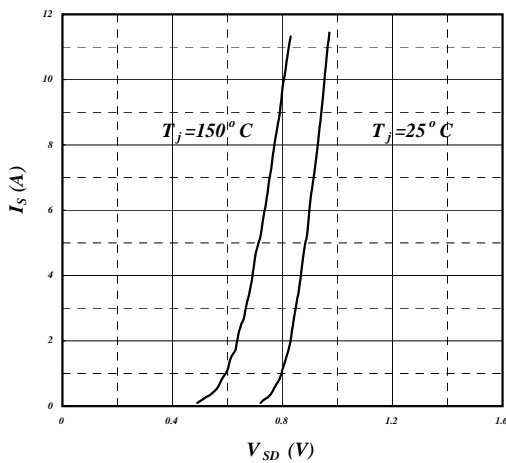

Fig 5. Forward Characteristic of Reverse Diode

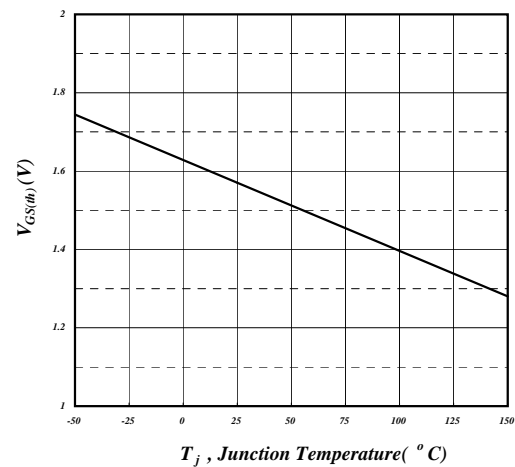

Fig 6. Gate Threshold Voltage v.s. Junction Temperature

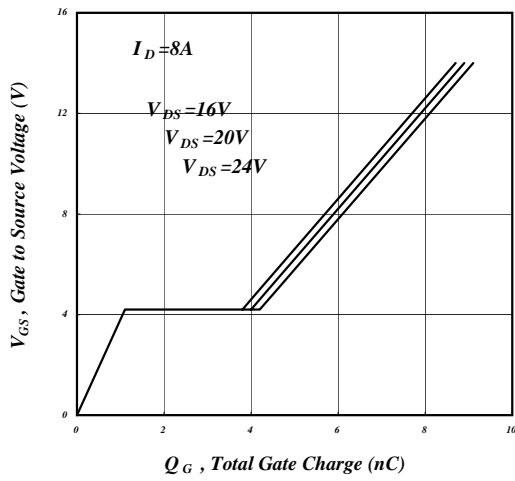

Fig 7. Gate Charge Characteristics

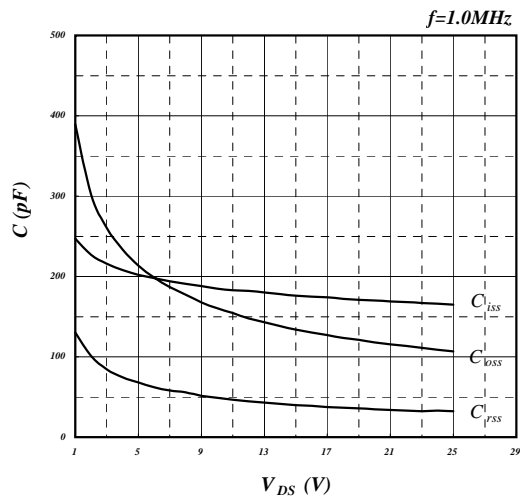

Fig 8. Typical Capacitance Characteristics

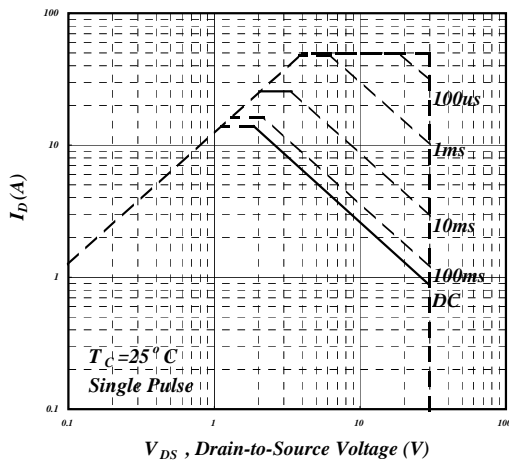

Fig 9. Maximum Safe Operating Area

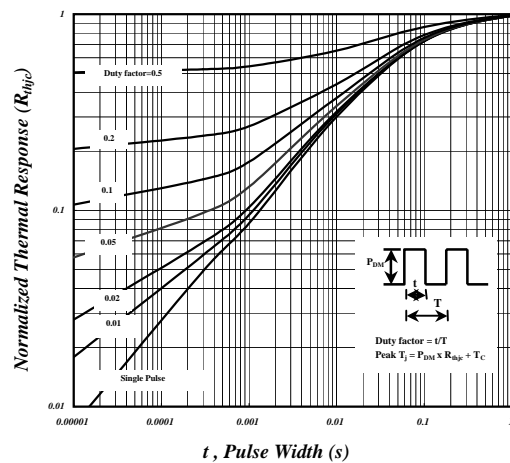

Fig 10. Effective Transient Thermal Impedance

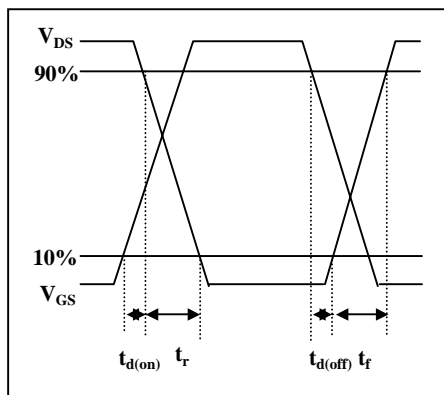

Fig 11. Switching Time Waveform

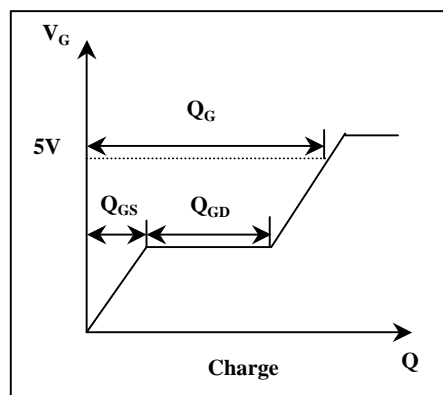
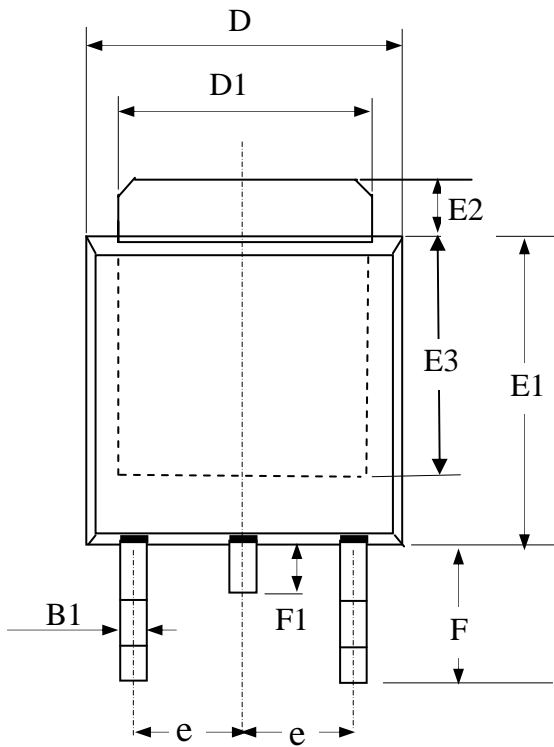

Fig 12. Gate Charge Waveform



Package Outline : TO-252



SYMBOLS	Millimeters		
	MIN	NOM	MAX
A2	1.80	2.30	2.80
A3	0.40	0.50	0.60
B1	0.40	0.70	1.00
D	6.00	6.50	7.00
D1	4.80	5.35	5.90
E3	3.50	4.00	4.50
F	2.20	2.63	3.05
F1	0.50	0.85	1.20
E1	5.10	5.70	6.30
E2	0.50	1.10	1.80
e	--	2.30	--
C	0.35	0.50	0.65

- 1.All Dimensions Are in Millimeters.
- 2.Dimension Does Not Include Mold Protrusions.

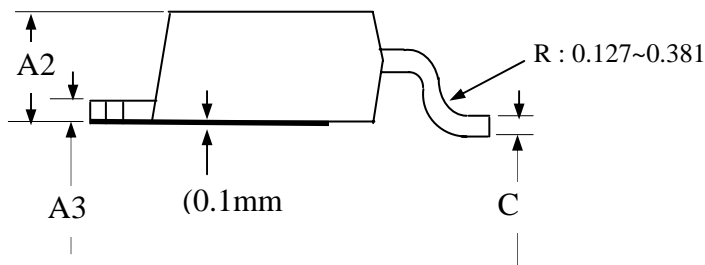

Part Marking Information & Packing : TO-252

Laser Marking

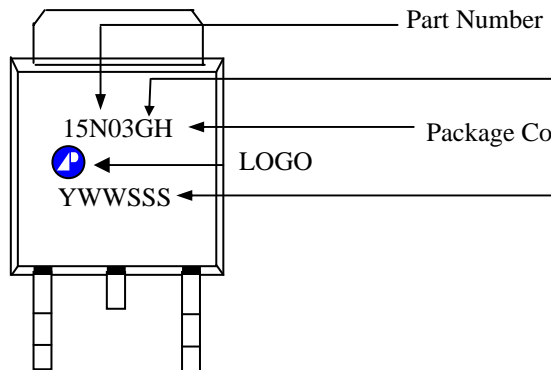

Meet Rohs requirement for low voltage MOSFET only

Date Code (YWWSSS)

Y : Last Digit Of The Year

WW : Week

SSS : Sequence



Package Outline : TO-251

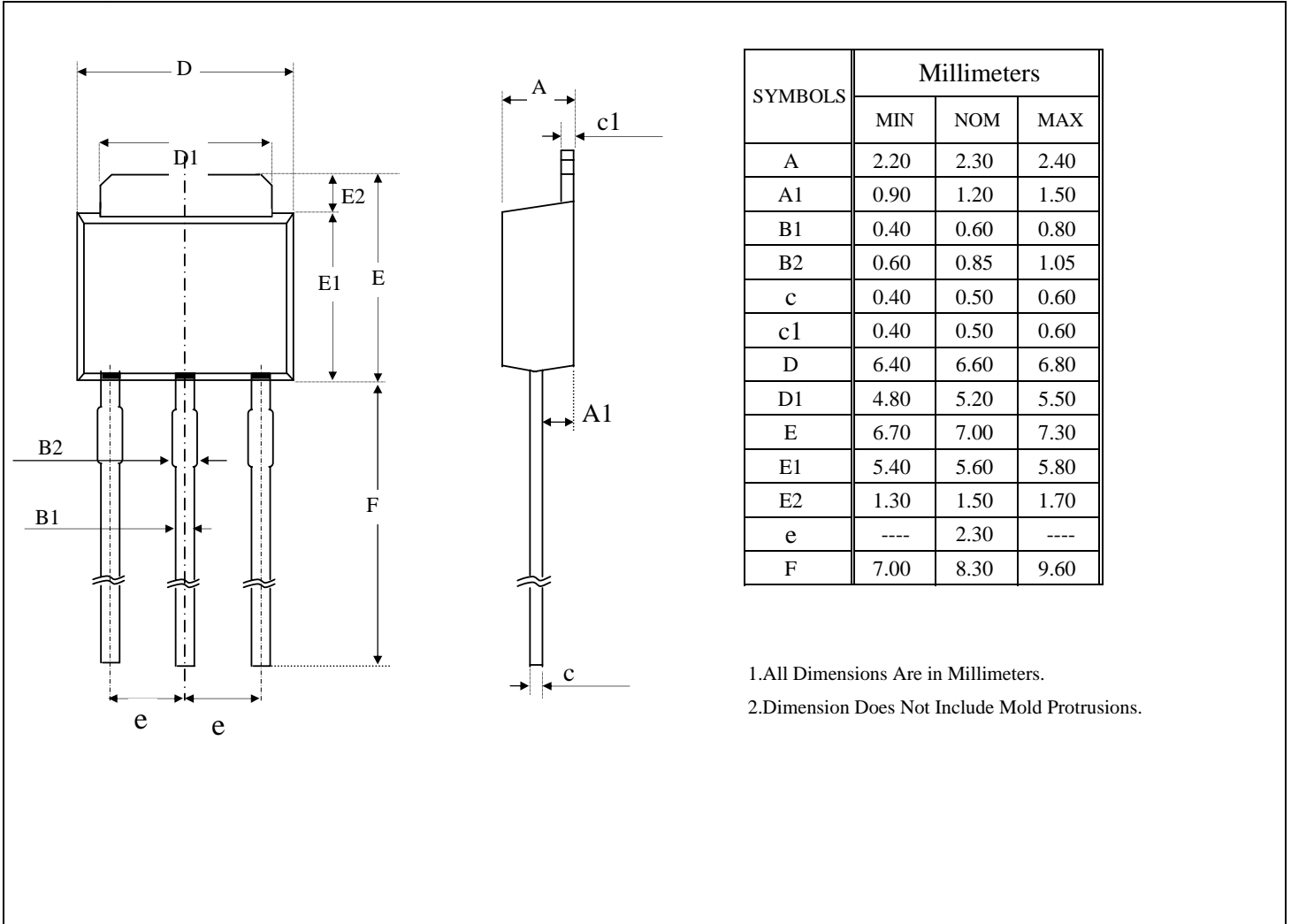

Part Marking Information & Packing : TO-251

