

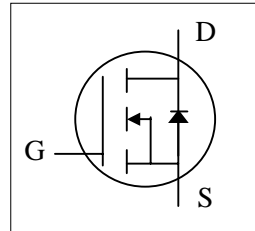

- ▼ **Low Gate Charge**
- ▼ **Simple Drive Requirement**
- ▼ **Fast Switching Characteristic**



| | |
|--------------|---------------|
| BV_{DSS} | 200V |
| $R_{DS(ON)}$ | 170m Ω |
| I_D | 18A |

Description

Advanced Power MOSFETs from APEC provide the designer with the best combination of fast switching, ruggedized device design, low on-resistance and cost-effectiveness.

The TO-220CFM isolation package is widely preferred for commercial-industrial through hole applications.

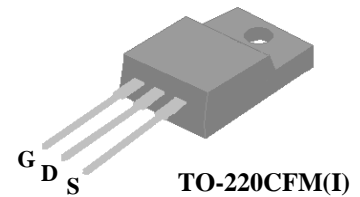

Absolute Maximum Ratings

| Symbol | Parameter | Rating | Units |
|-----------------------|--|------------|---------------|
| V_{DS} | Drain-Source Voltage | 200 | V |
| V_{GS} | Gate-Source Voltage | ± 20 | V |
| $I_D@T_C=25^\circ C$ | Continuous Drain Current, V_{GS} @ 10V | 18 | A |
| $I_D@T_C=100^\circ C$ | Continuous Drain Current, V_{GS} @ 10V | 9.5 | A |
| I_{DM} | Pulsed Drain Current ¹ | 60 | A |
| $P_D@T_C=25^\circ C$ | Total Power Dissipation | 34.7 | W |
| | Linear Derating Factor | 0.28 | W/ $^\circ C$ |
| T_{STG} | Storage Temperature Range | -55 to 150 | $^\circ C$ |
| T_J | Operating Junction Temperature Range | -55 to 150 | $^\circ C$ |

Thermal Data

| Symbol | Parameter | Value | Units |
|--------|--|-------|--------------|
| Rthj-c | Maximum Thermal Resistance, Junction-case | 3.6 | $^\circ C/W$ |
| Rthj-a | Maximum Thermal Resistance, Junction-ambient | 65 | $^\circ C/W$ |



AP18N20GI

Electrical Characteristics @T_j=25°C(unless otherwise specified)

| Symbol | Parameter | Test Conditions | Min. | Typ. | Max. | Units |
|---------------------|--|--|------|------|------|-------|
| BV _{DSS} | Drain-Source Breakdown Voltage | V _{GS} =0V, I _D =1mA | 200 | - | - | V |
| R _{DS(ON)} | Static Drain-Source On-Resistance ² | V _{GS} =10V, I _D =8A | - | - | 170 | mΩ |
| V _{GS(th)} | Gate Threshold Voltage | V _{DS} =V _{GS} , I _D =250uA | 2 | - | 4 | V |
| g _{fs} | Forward Transconductance | V _{DS} =10V, I _D =10A | - | 9.5 | - | S |
| I _{DSS} | Drain-Source Leakage Current | V _{DS} =200V, V _{GS} =0V | - | - | 10 | uA |
| | Drain-Source Leakage Current (T _j =150°C) | V _{DS} =160V, V _{GS} =0V | - | - | 100 | uA |
| I _{GSS} | Gate-Source Leakage | V _{GS} =±20V | - | - | ±100 | nA |
| Q _g | Total Gate Charge ² | I _D =10A | - | 19 | 30 | nC |
| Q _{gs} | Gate-Source Charge | V _{DS} =160V | - | 5 | - | nC |
| Q _{gd} | Gate-Drain ("Miller") Charge | V _{GS} =10V | - | 6 | - | nC |
| t _{d(on)} | Turn-on Delay Time ² | V _{DD} =100V | - | 9 | - | ns |
| t _r | Rise Time | I _D =11A | - | 21 | - | ns |
| t _{d(off)} | Turn-off Delay Time | R _G =9.1Ω, V _{GS} =10V | - | 25 | - | ns |
| t _f | Fall Time | R _D =9.1Ω | - | 19 | - | ns |
| C _{iss} | Input Capacitance | V _{GS} =0V | - | 1065 | 1700 | pF |
| C _{oss} | Output Capacitance | V _{DS} =25V | - | 185 | - | pF |
| C _{rss} | Reverse Transfer Capacitance | f=1.0MHz | - | 3 | - | pF |
| R _g | Gate Resistance | f=1.0MHz | - | 1.6 | 2.4 | Ω |

Source-Drain Diode

| Symbol | Parameter | Test Conditions | Min. | Typ. | Max. | Units |
|-----------------|------------------------------------|--|------|------|------|-------|
| V _{SD} | Forward On Voltage ² | I _S =10A, V _{GS} =0V | - | - | 1.3 | V |
| t _{rr} | Reverse Recovery Time ² | I _S =10A, V _{GS} =0V | - | 180 | - | ns |
| Q _{rr} | Reverse Recovery Charge | dI/dt=100A/μs | - | 1150 | - | nC |

Notes:

- 1.Pulse width limited by Max junction temperature.
- 2.Pulse test

THIS PRODUCT IS SENSITIVE TO ELECTROSTATIC DISCHARGE, PLEASE HANDLE WITH CAUTION.

USE OF THIS PRODUCT AS A CRITICAL COMPONENT IN LIFE SUPPORT OR OTHER SIMILAR SYSTEMS IS NOT AUTHORIZED.

APEC DOES NOT ASSUME ANY LIABILITY ARISING OUT OF THE APPLICATION OR USE OF ANY PRODUCT OR CIRCUIT DESCRIBED HEREIN; NEITHER DOES IT CONVEY ANY LICENSE UNDER ITS PATENT RIGHTS, NOR THE RIGHTS OF OTHERS.

APEC RESERVES THE RIGHT TO MAKE CHANGES WITHOUT FURTHER NOTICE TO ANY PRODUCTS HEREIN TO IMPROVE RELIABILITY, FUNCTION OR DESIGN.

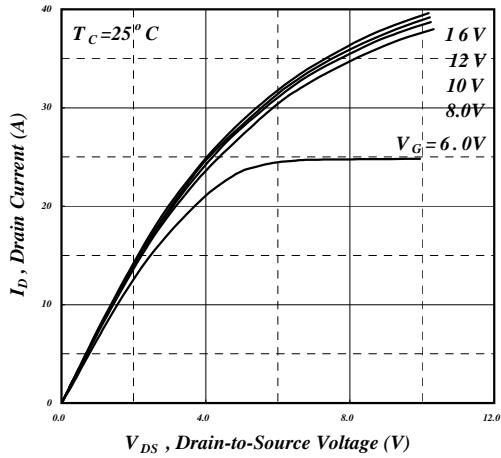

Fig 1. Typical Output Characteristics

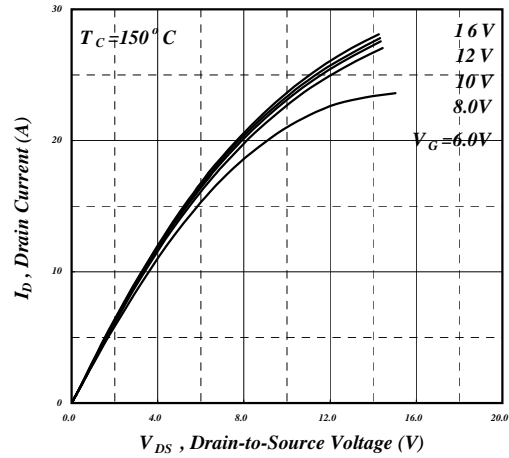

Fig 2. Typical Output Characteristics

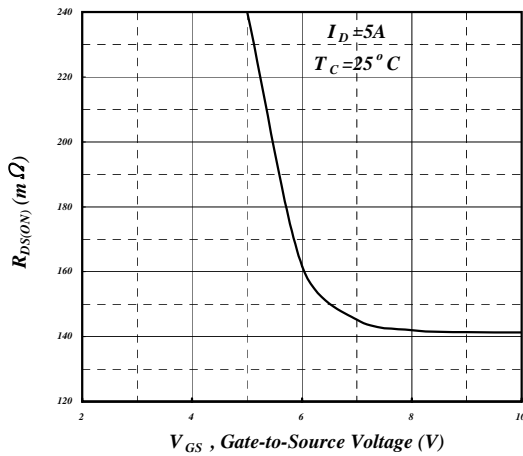

Fig 3. On-Resistance v.s. Gate Voltage

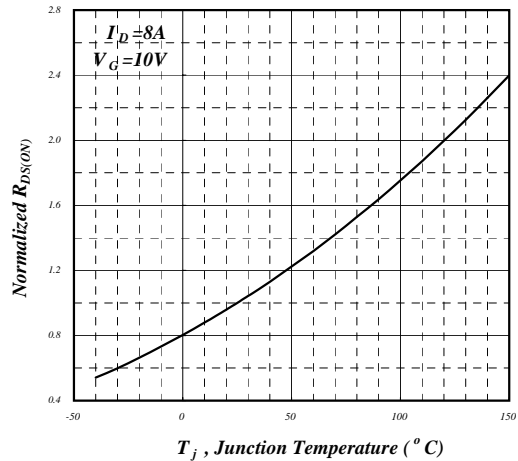

Fig 4. Normalized On-Resistance v.s. Junction Temperature

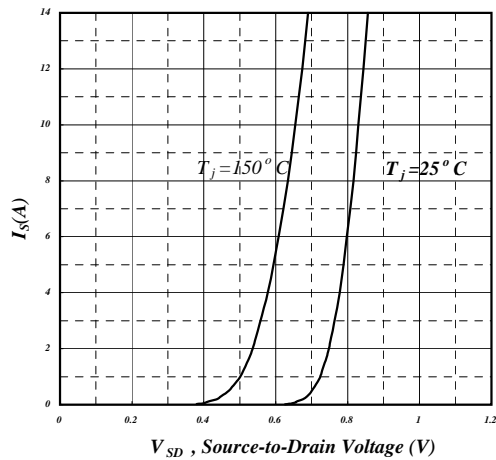

Fig 5. Forward Characteristic of Reverse Diode

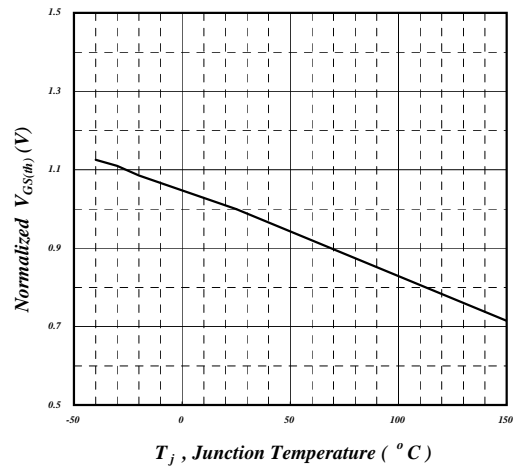

Fig 6. Gate Threshold Voltage v.s. Junction Temperature

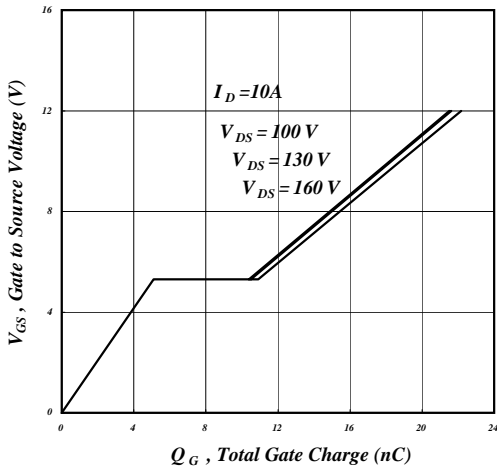

Fig 7. Gate Charge Characteristics

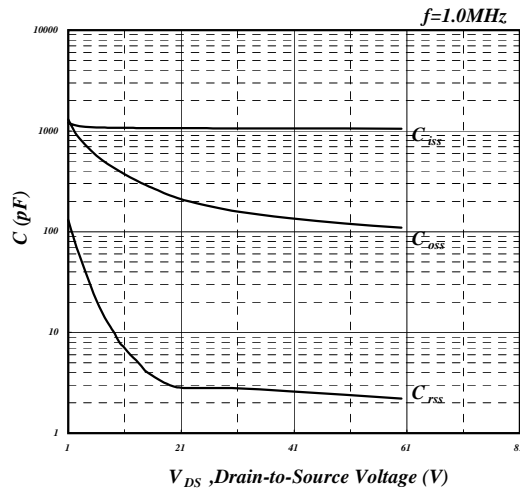

Fig 8. Typical Capacitance Characteristics

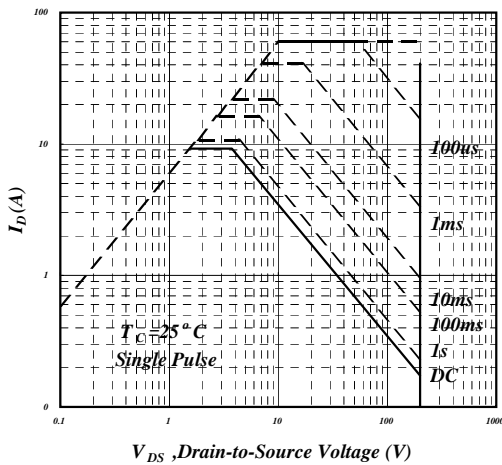

Fig 9. Maximum Safe Operating Area

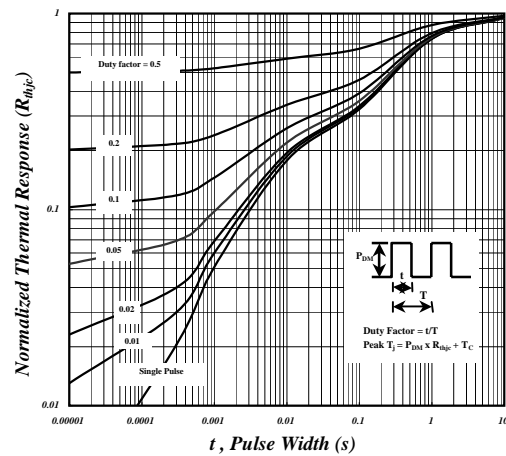

Fig 10. Effective Transient Thermal Impedance

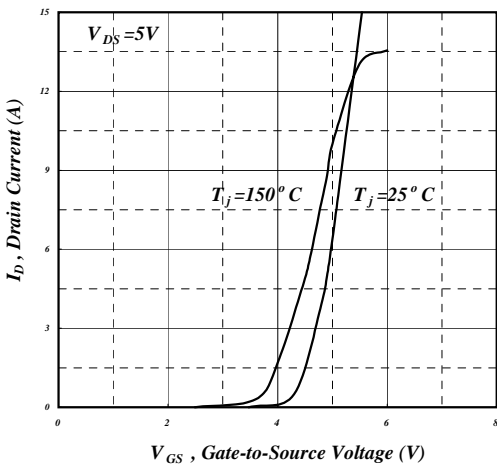

Fig 11. Transfer Characteristics

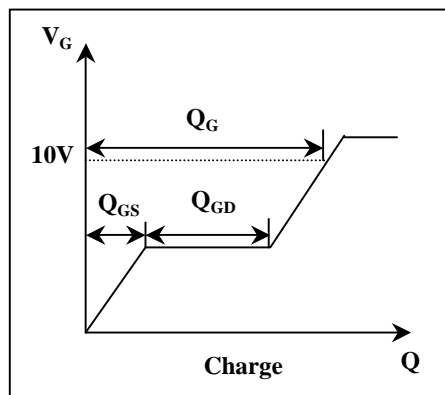
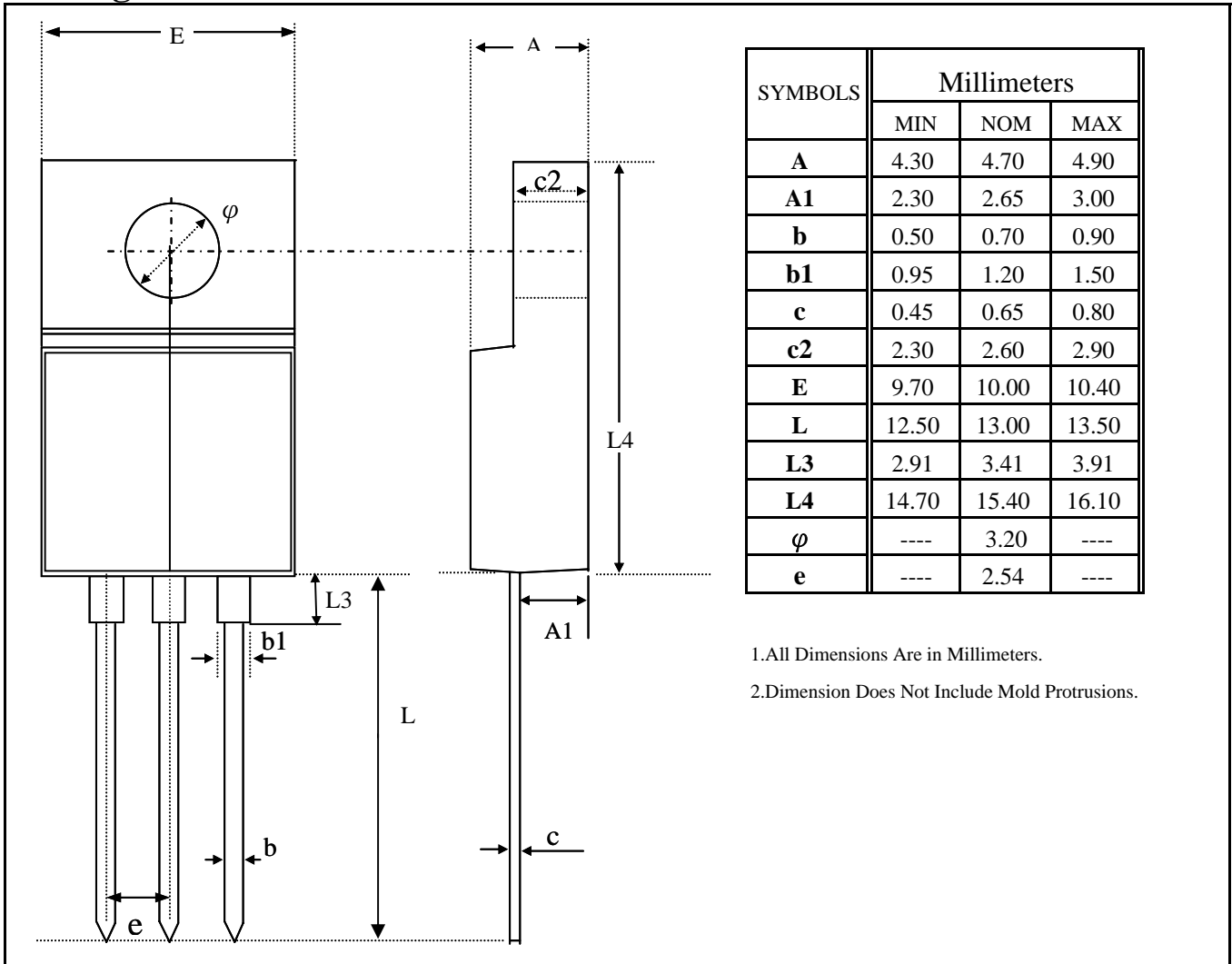

Fig 12. Gate Charge Waveform



ADVANCED POWER ELECTRONICS CORP.

Package Outline : TO-220CFM



Part Marking Information & Packing : TO-220CFM

