

AP4002T

RoHS-compliant Product



**Advanced Power
Electronics Corp.**

N-CHANNEL ENHANCEMENT MODE

POWER MOSFET

- ▼ 100% Avalanche Test
- ▼ Fast Switching Characteristics
- ▼ Simple Drive Requirement

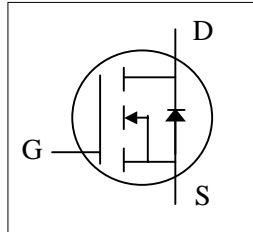

BV_{DSS}	600V
$R_{DS(ON)}$	5 Ω
I_D	400mA

Description

Advanced Power MOSFETs utilized advanced processing techniques to achieve the lowest possible on-resistance, extremely efficient and cost-effectiveness device.

The TO-92 package is widely used for commercial-industrial applications.

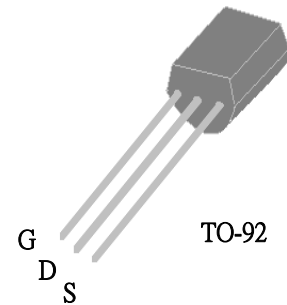

Absolute Maximum Ratings

Symbol	Parameter	Rating	Units
V_{DS}	Drain-Source Voltage	600	V
V_{GS}	Gate-Source Voltage	± 30	V
$I_D @ T_L = 25^\circ C$	Continuous Drain Current, $V_{GS} @ 10V$	400	mA
I_{DM}	Pulsed Drain Current ¹	3	A
$P_D @ T_L = 25^\circ C$	Total Power Dissipation	2	W
	Linear Derating Factor	0.017	W/ $^\circ C$
E_{AS}	Single Pulse Avalanche Energy ²	20	mJ
I_{AR}	Avalanche Current	2	A
T_{STG}	Storage Temperature Range	-55 to 150	$^\circ C$
T_J	Operating Junction Temperature Range	-55 to 150	$^\circ C$

Thermal Data

Symbol	Parameter	Value	Unit
Rthj-a	Maximum Thermal Resistance, Junction-ambient	150	$^\circ C/W$
Rthj-l	Maximum Thermal Resistance, Junction-lead	60	$^\circ C/W$



Electrical Characteristics @ $T_j=25^{\circ}\text{C}$ (unless otherwise specified)

Symbol	Parameter	Test Conditions	Min.	Typ.	Max.	Units
BV_{DSS}	Drain-Source Breakdown Voltage	$V_{GS}=0V, I_D=1mA$	600	-	-	V
$R_{DS(ON)}$	Static Drain-Source On-Resistance	$V_{GS}=10V, I_D=400mA$	-	-	5	Ω
$V_{GS(th)}$	Gate Threshold Voltage	$V_{DS}=V_{GS}, I_D=250\mu A$	2	-	4	V
g_{fs}	Forward Transconductance	$V_{DS}=10V, I_D=400mA$	-	570	-	mS
I_{DSS}	Drain-Source Leakage Current	$V_{DS}=600V, V_{GS}=0V$	-	-	100	μA
I_{GSS}	Gate-Source Leakage	$V_{GS}=\pm 30V$	-	-	± 1	μA
Q_g	Total Gate Charge ³	$I_D=2A$	-	12	19	nC
Q_{gs}	Gate-Source Charge	$V_{DS}=480V$	-	2	-	nC
Q_{gd}	Gate-Drain ("Miller") Charge	$V_{GS}=10V$	-	5.5	-	nC
$t_{d(on)}$	Turn-on Delay Time ³	$V_{DD}=200V$	-	10	-	ns
t_r	Rise Time	$I_D=1A$	-	12	-	ns
$t_{d(off)}$	Turn-off Delay Time	$R_G=50\Omega, V_{GS}=10V$	-	52	-	ns
t_f	Fall Time	$R_D=200\Omega$	-	19	-	ns
C_{iss}	Input Capacitance	$V_{GS}=0V$	-	375	600	pF
C_{oss}	Output Capacitance	$V_{DS}=10V$	-	170	-	pF
C_{rss}	Reverse Transfer Capacitance	$f=1.0MHz$	-	45	-	pF

Source-Drain Diode

Symbol	Parameter	Test Conditions	Min.	Typ.	Max.	Units
V_{SD}	Forward On Voltage ³	$T_j=25^{\circ}\text{C}, I_S=2A, V_{GS}=0V$	-	-	1.5	V
t_{rr}	Reverse Recovery Time ³	$I_S=2A, V_{GS}=0V,$	-	340	-	ns
Q_{rr}	Reverse Recovery Charge	$di/dt=100A/\mu s$	-	2.2	-	μC

Notes:

- 1.Pulse width limited by Max. junction temperature.
- 2.Starting $T_j=25^{\circ}\text{C}$, $V_{DD}=50V$, $L=10mH$, $R_G=25\Omega$
- 3.Pulse test

THIS PRODUCT IS AN ELECTROSTATIC SENSITIVE, PLEASE HANDLE WITH CAUTION.

THIS PRODUCT HAS BEEN QUALIFIED FOR CONSUMER MARKET. APPLICATIONS OR USES AS CRITERIAL COMPONENT IN LIFE SUPPORT DEVICE OR SYSTEM ARE NOT AUTHORIZED.

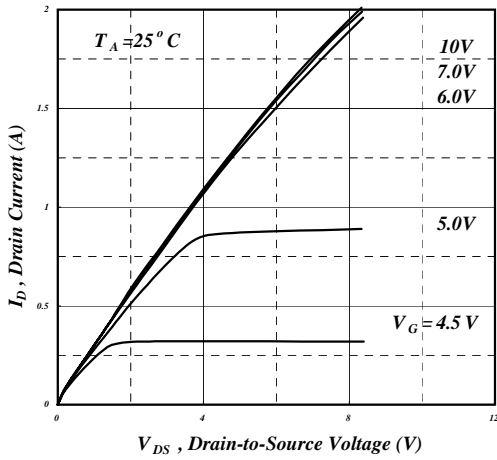

Fig 1. Typical Output Characteristics

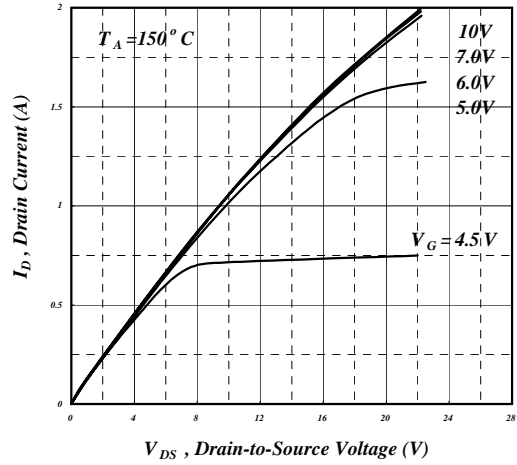

Fig 2. Typical Output Characteristics

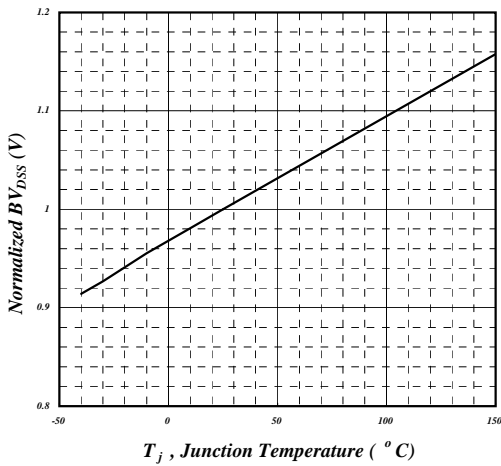

Fig 3. Normalized BV_{DSS} v.s. Junction Temperature

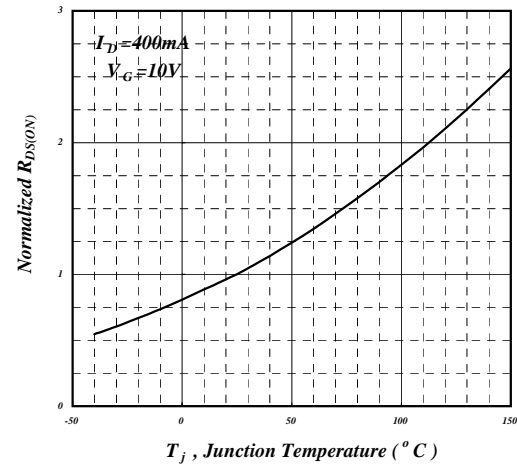

Fig 4. Normalized On-Resistance v.s. Junction Temperature

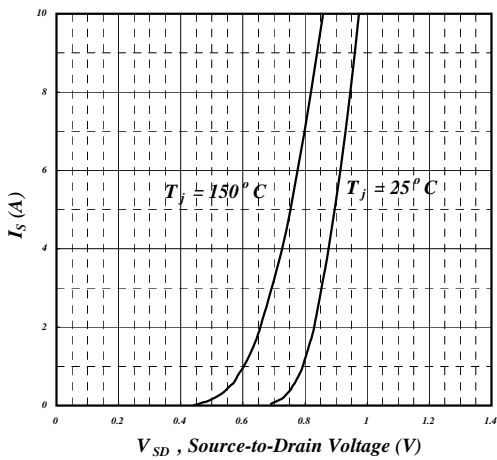

Fig 5. Forward Characteristic of Reverse Diode

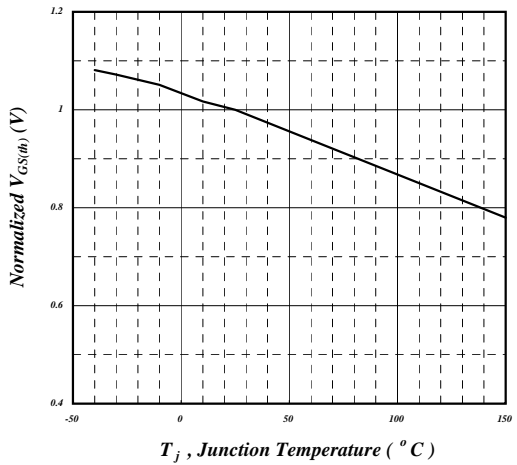

Fig 6. Gate Threshold Voltage v.s. Junction Temperature

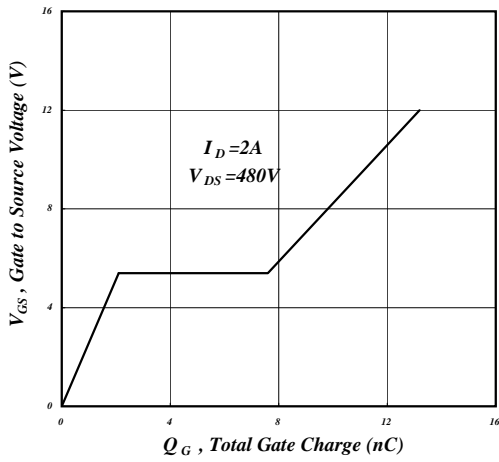

Fig 7. Gate Charge Characteristics

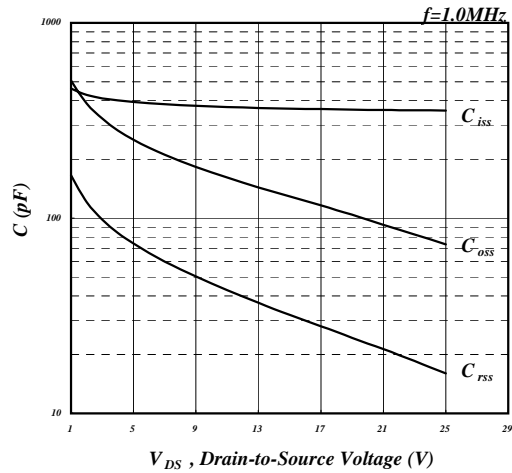

Fig 8. Typical Capacitance Characteristics

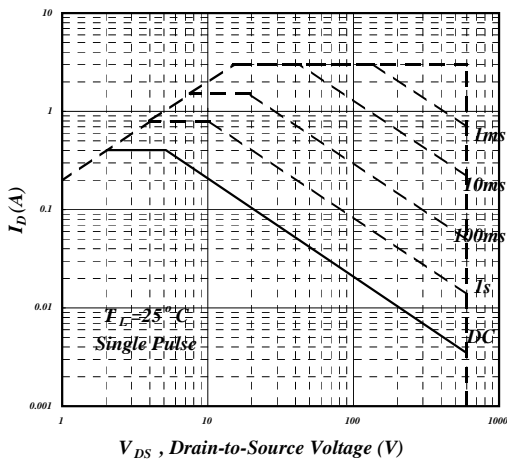

Fig 9. Maximum Safe Operating Area

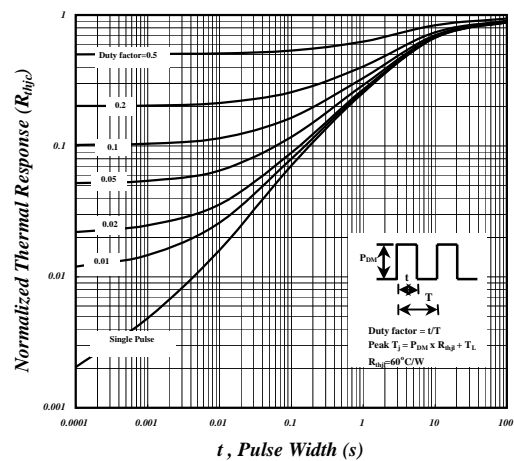

Fig 10. Effective Transient Thermal Impedance

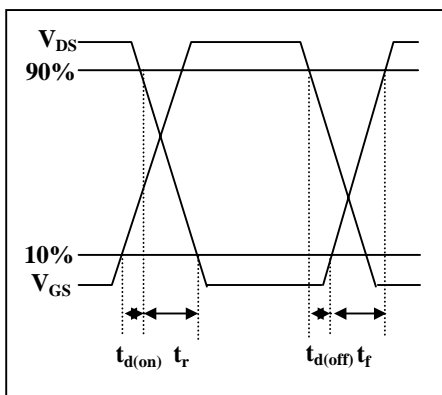

Fig 11. Switching Time Waveform

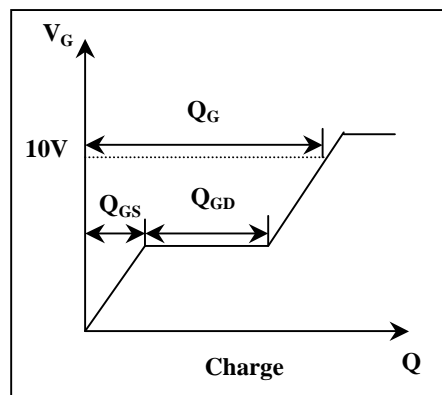
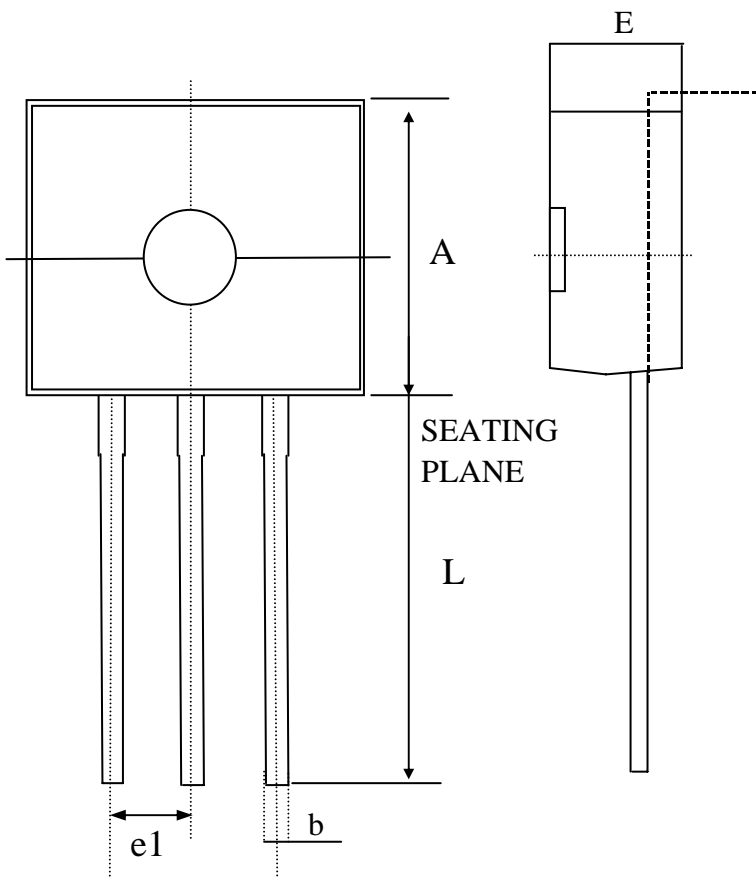

Fig 12. Gate Charge Waveform



Package Outline : TO-92



SYMBOL	Millimeters		
	MIN	NOM	MAX
A	4.32	4.83	5.34
D	4.1	4.8	5.3
E	3.1	3.9	4.7
b	----	0.38	----
L	12.7	---	----
e1	----	1.27	----

- 1.All Dimensions Are in Millimeters.
- 2.Dimension Does Not Include Mold Protrusions.

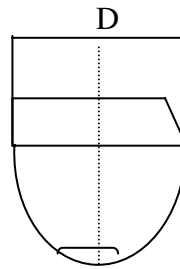

Part Marking Information & Packing : TO-92

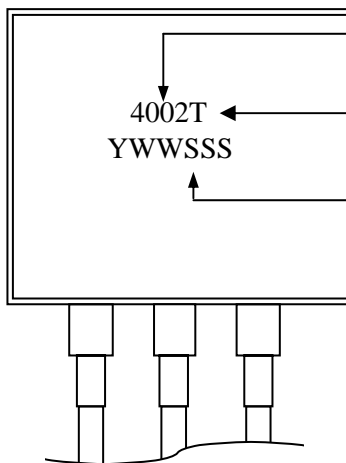

Part Number

Package Code

Date Code (YWWSSS)

Y : Last Digit Of The Year

WW : Week

SSS : Sequence