

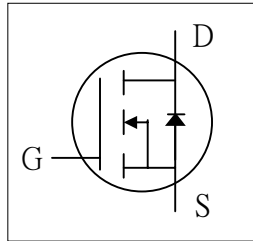

- ▼ 100% Avalanche Test
- ▼ Fast Switching Characteristic
- ▼ Simple Drive Requirement



$BV_{DSS}$	600V
$R_{DS(ON)}$	2.4 $\Omega$
$I_D$	4A

## Description

Advanced Power MOSFETs from APEC provide the designer with the best combination of fast switching, ruggedized device design, low on-resistance and cost-effectiveness.

The TO-220CFM isolation package is widely preferred for all commercial-industrial through hole applications.

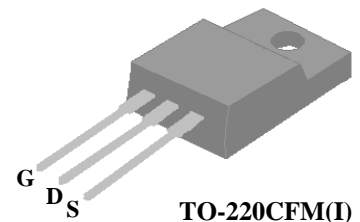

## Absolute Maximum Ratings

Symbol	Parameter	Rating	Units
$V_{DS}$	Drain-Source Voltage	600	V
$V_{GS}$	Gate-Source Voltage	+30	V
$I_D@T_C=25^\circ\text{C}$	Continuous Drain Current, $V_{GS}$ @ 10V	4	A
$I_D@T_C=100^\circ\text{C}$	Continuous Drain Current, $V_{GS}$ @ 10V	2.5	A
$I_{DM}$	Pulsed Drain Current <sup>1</sup>	15	A
$P_D@T_C=25^\circ\text{C}$	Total Power Dissipation	33	W
	Linear Derating Factor	0.26	W/ $^\circ\text{C}$
$E_{AS}$	Single Pulse Avalanche Energy <sup>2</sup>	8	mJ
$I_{AR}$	Avalanche Current	4	A
$T_{STG}$	Storage Temperature Range	-55 to 150	$^\circ\text{C}$
$T_J$	Operating Junction Temperature Range	-55 to 150	$^\circ\text{C}$

## Thermal Data

Symbol	Parameter	Value	Unit
Rthj-c	Maximum Thermal Resistance, Junction-case	3.8	$^\circ\text{C}/\text{W}$
Rthj-a	Maximum Thermal Resistance, Junction-ambient	65	$^\circ\text{C}/\text{W}$

**Electrical Characteristics @ $T_j=25^{\circ}\text{C}$  (unless otherwise specified)**

Symbol	Parameter	Test Conditions	Min.	Typ.	Max.	Units
$BV_{DSS}$	Drain-Source Breakdown Voltage	$V_{GS}=0V, I_D=1mA$	600	-	-	V
$\Delta BV_{DSS}/\Delta T_j$	Breakdown Voltage Temperature Coefficient	Reference to $25^{\circ}\text{C}$ , $I_D=1mA$	-	0.6	-	$V/^{\circ}\text{C}$
$R_{DS(ON)}$	Static Drain-Source On-Resistance <sup>3</sup>	$V_{GS}=10V, I_D=2A$	-	-	2.4	$\Omega$
$V_{GS(th)}$	Gate Threshold Voltage	$V_{DS}=V_{GS}, I_D=250\mu A$	2	-	4	V
$g_{fs}$	Forward Transconductance	$V_{DS}=10V, I_D=2A$	-	2.5	-	S
$I_{DSS}$	Drain-Source Leakage Current	$V_{DS}=600V, V_{GS}=0V$	-	-	10	$\mu A$
	Drain-Source Leakage Current ( $T_j=125^{\circ}\text{C}$ )	$V_{DS}=480V, V_{GS}=0V$	-	-	500	$\mu A$
$I_{GSS}$	Gate-Source Leakage	$V_{GS}=\pm 30V, V_{DS}=0V$	-	-	$\pm 100$	nA
$Q_g$	Total Gate Charge <sup>3</sup>	$I_D=4A$	-	16.7	-	nC
$Q_{gs}$	Gate-Source Charge	$V_{DS}=480V$	-	4.1	-	nC
$Q_{gd}$	Gate-Drain ("Miller") Charge	$V_{GS}=10V$	-	4.9	-	nC
$t_{d(on)}$	Turn-on Delay Time <sup>3</sup>	$V_{DD}=300V$	-	11	-	ns
$t_r$	Rise Time	$I_D=4A$	-	8.3	-	ns
$t_{d(off)}$	Turn-off Delay Time	$R_G=10\Omega, V_{GS}=10V$	-	23.8	-	ns
$t_f$	Fall Time	$R_D=75\Omega$	-	8.2	-	ns
$C_{iss}$	Input Capacitance	$V_{GS}=0V$	-	950	-	pF
$C_{oss}$	Output Capacitance	$V_{DS}=25V$	-	65	-	pF
$C_{rss}$	Reverse Transfer Capacitance	$f=1.0MHz$	-	6	-	pF

**Source-Drain Diode**

Symbol	Parameter	Test Conditions	Min.	Typ.	Max.	Units
$I_S$	Continuous Source Current ( Body Diode )	$V_D=V_G=0V, V_S=1.5V$	-	-	4	A
$I_{SM}$	Pulsed Source Current ( Body Diode ) <sup>1</sup>		-	-	15	A
$V_{SD}$	Forward On Voltage <sup>3</sup>	$T_j=25^{\circ}\text{C}, I_S=4A, V_{GS}=0V$	-	-	1.5	V

**Notes:**

1. Pulse width limited by max. junction temperature
2. Starting  $T_j=25^{\circ}\text{C}$ ,  $V_{DD}=50V$ ,  $L=1mH$ ,  $R_G=25\Omega$ ,  $I_{AS}=4A$ .
3. Pulse test

THIS PRODUCT IS SENSITIVE TO ELECTROSTATIC DISCHARGE, PLEASE HANDLE WITH CAUTION.

USE OF THIS PRODUCT AS A CRITICAL COMPONENT IN LIFE SUPPORT OR OTHER SIMILAR SYSTEMS IS NOT AUTHORIZED.

APEC DOES NOT ASSUME ANY LIABILITY ARISING OUT OF THE APPLICATION OR USE OF ANY PRODUCT OR CIRCUIT DESCRIBED HEREIN; NEITHER DOES IT CONVEY ANY LICENSE UNDER ITS PATENT RIGHTS, NOR THE RIGHTS OF OTHERS.

APEC RESERVES THE RIGHT TO MAKE CHANGES WITHOUT FURTHER NOTICE TO ANY PRODUCTS HEREIN TO IMPROVE RELIABILITY, FUNCTION OR DESIGN.

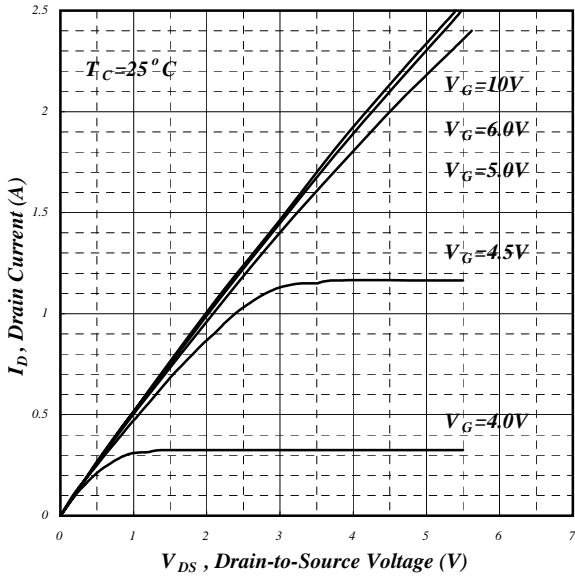

Fig 1. Typical Output Characteristics

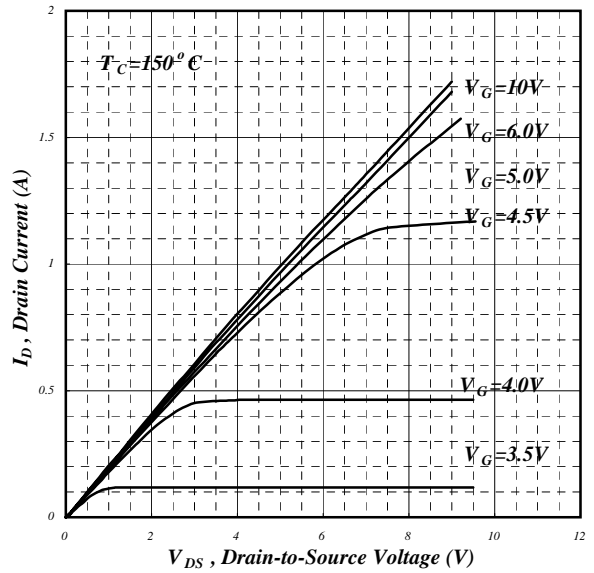

Fig 2. Typical Output Characteristics

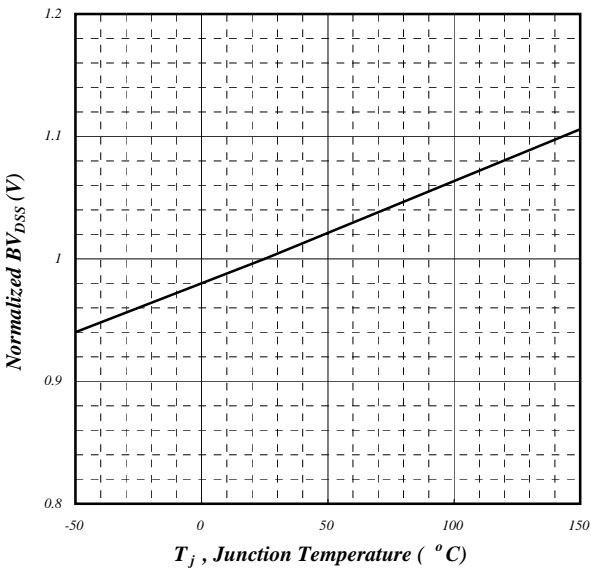

Fig 3. Normalized  $BV_{DS}$  v.s. Junction Temperature

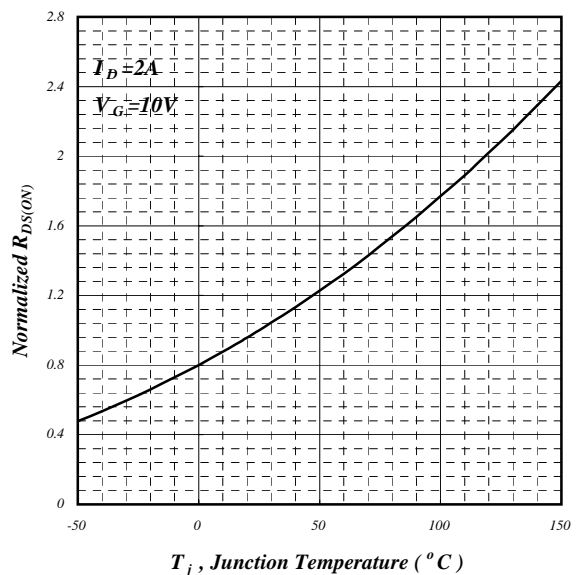

Fig 4. Normalized On-Resistance v.s. Junction Temperature

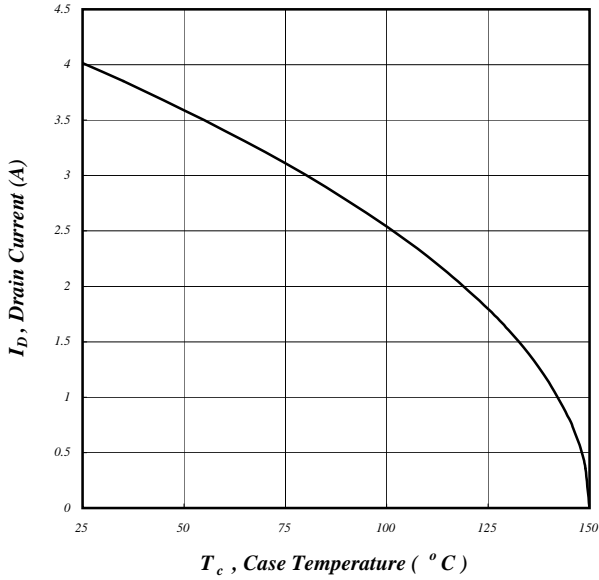

Fig 5. Maximum Drain Current v.s. Case Temperature

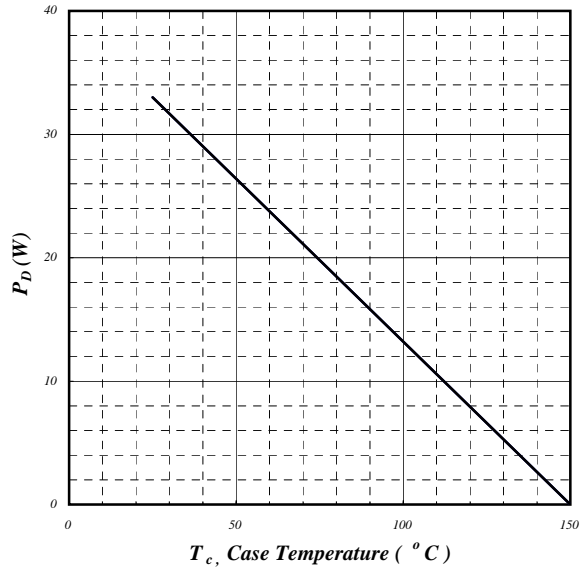

Fig 6. Typical Power Dissipation

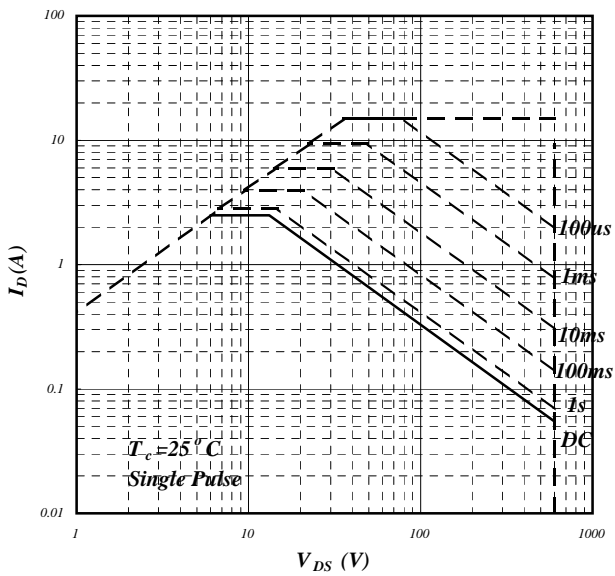

Fig 7. Maximum Safe Operating Area

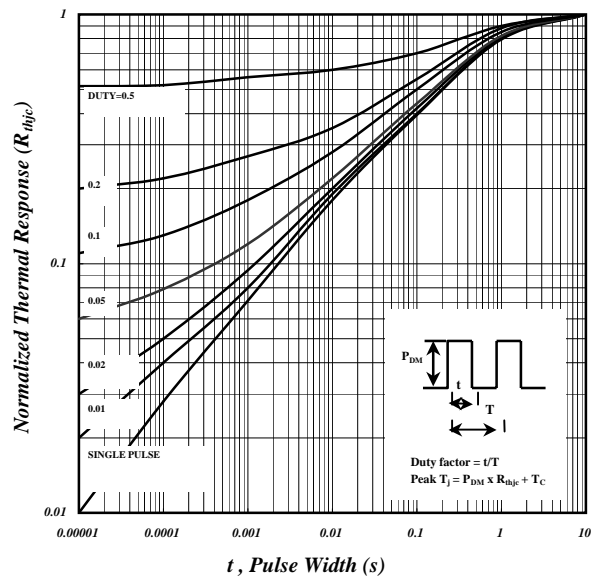

Fig 8. Effective Transient Thermal Impedance

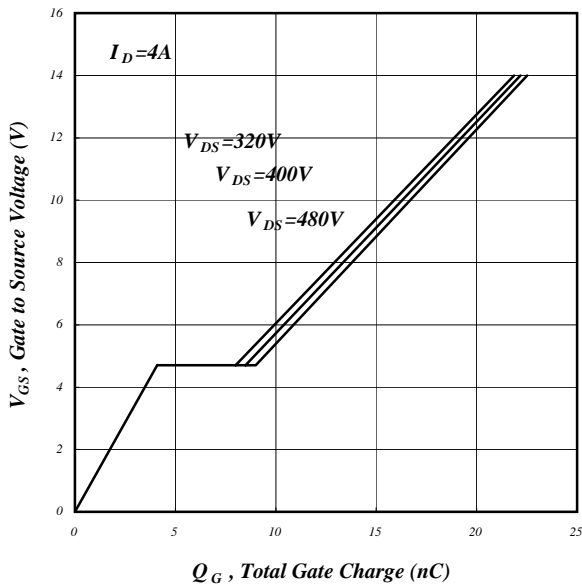

Fig 9. Gate Charge Characteristics

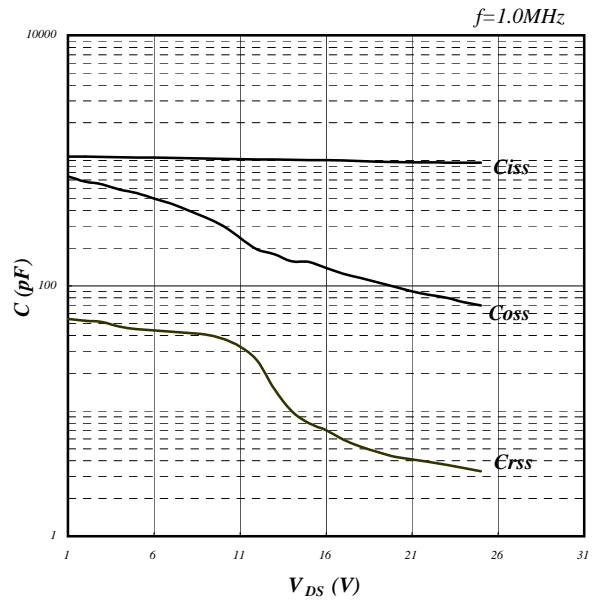

Fig 10. Typical Capacitance Characteristics

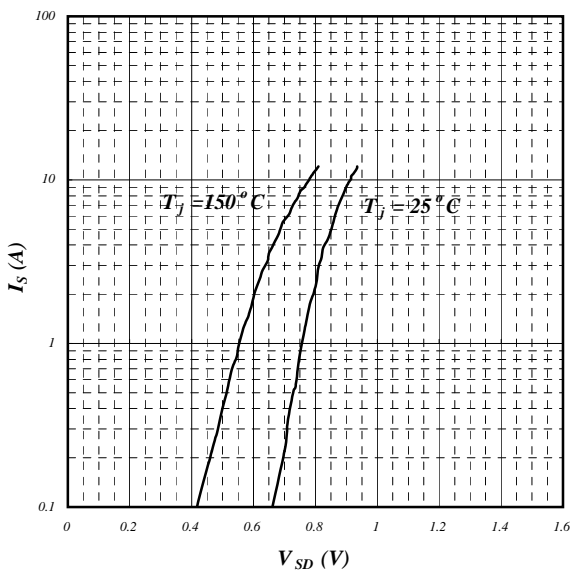

Fig 11. Forward Characteristic of Reverse Diode

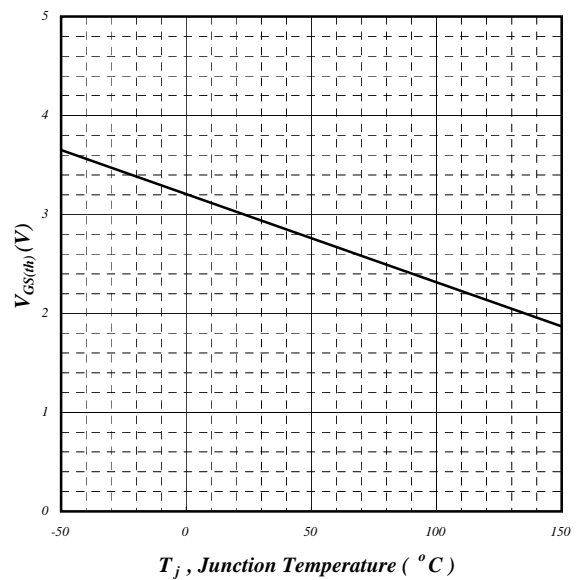

Fig 12. Gate Threshold Voltage v.s. Junction Temperature

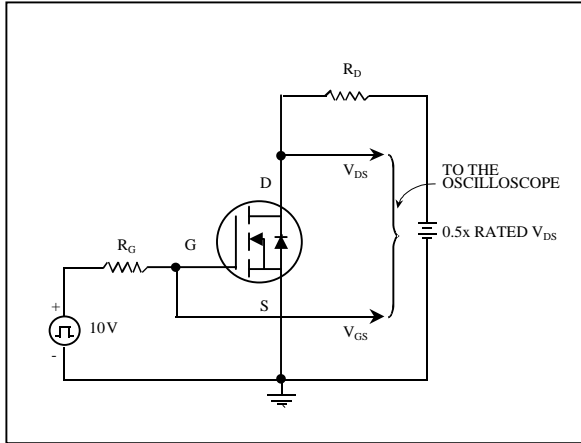

Fig 13. Switching Time Circuit

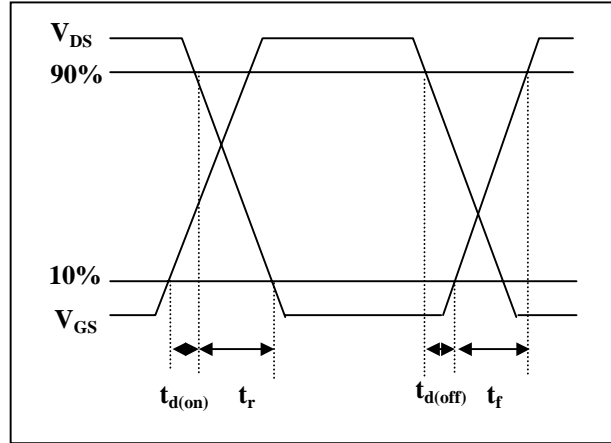

Fig 14. Switching Time Waveform

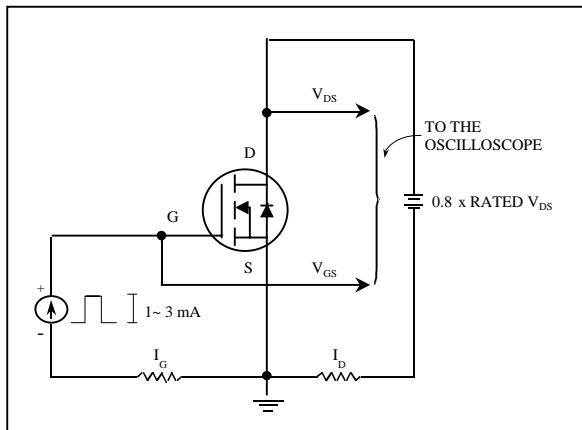

Fig 15. Gate Charge Circuit

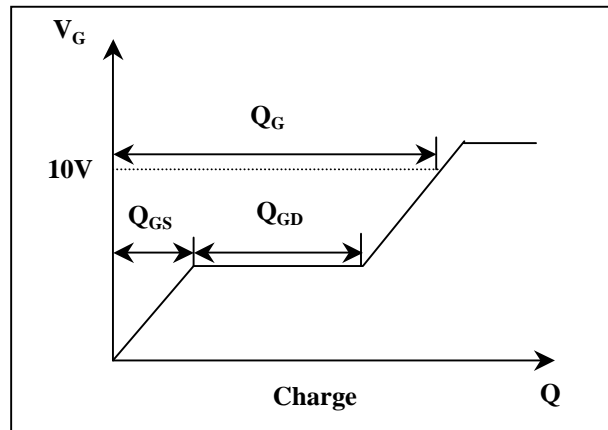

Fig 16. Gate Charge Waveform