

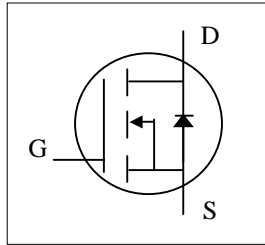

- ▼ 100% Avalanche Test
- ▼ Lower Gate Charge
- ▼ Fast Switching Characteristic
- ▼ Simple Drive Requirement



BV_{DSS}	700V
$R_{DS(ON)}$	8.8 Ω
I_D	1.4A

Description

The TO-252 package is widely preferred for all commercial-industrial surface mount applications and suited for AC/DC converters. The through-hole version (AP02N60J-H) is available for low-profile applications.

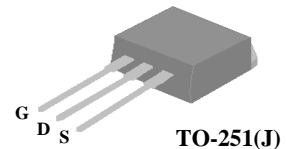
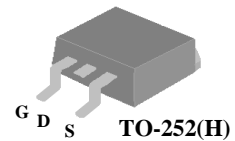

Absolute Maximum Ratings

Symbol	Parameter	Rating	Units
V_{DS}	Drain-Source Voltage	700	V
V_{GS}	Gate-Source Voltage	± 30	V
$I_D@T_C=25^\circ C$	Continuous Drain Current, $V_{GS} @ 10V$	1.4	A
$I_D@T_C=100^\circ C$	Continuous Drain Current, $V_{GS} @ 10V$	0.9	A
I_{DM}	Pulsed Drain Current ¹	5.6	A
$P_D@T_C=25^\circ C$	Total Power Dissipation	39	W
	Linear Derating Factor	0.31	W/ $^\circ C$
E_{AS}	Single Pulse Avalanche Energy ²	49	mJ
I_{AR}	Avalanche Current	1.4	A
E_{AR}	Repetitive Avalanche Energy	0.5	mJ
T_{STG}	Storage Temperature Range	-55 to 150	$^\circ C$
T_J	Operating Junction Temperature Range	-55 to 150	$^\circ C$

Thermal Data

Symbol	Parameter	Value	Units
Rthj-c	Maximum Thermal Resistance, Junction-case	3.2	$^\circ C/W$
Rthj-a	Maximum Thermal Resistance, Junction-ambient (PCB mount) ⁴	62.5	$^\circ C/W$
Rthj-a	Maximum Thermal Resistance, Junction-ambient	110	$^\circ C/W$



AP02N60H/J-H

Electrical Characteristics @ $T_j=25^{\circ}\text{C}$ (unless otherwise specified)

Symbol	Parameter	Test Conditions	Min.	Typ.	Max.	Units
BV_{DSS}	Drain-Source Breakdown Voltage	$V_{GS}=0V, I_D=10mA$	700	-	-	V
$\Delta BV_{DSS}/\Delta T_j$	Breakdown Voltage Temperature Coefficient	Reference to 25°C , $I_D=1mA$	-	0.6	-	$V/^{\circ}\text{C}$
$R_{DS(ON)}$	Static Drain-Source On-Resistance	$V_{GS}=10V, I_D=0.6A$	-	-	8.8	Ω
$V_{GS(th)}$	Gate Threshold Voltage	$V_{DS}=V_{GS}, I_D=250\mu A$	2	-	4	V
g_{fs}	Forward Transconductance	$V_{DS}=10V, I_D=1A$	-	0.2	-	S
I_{DSS}	Drain-Source Leakage Current	$V_{DS}=600V, V_{GS}=0V$	-	-	10	μA
	Drain-Source Leakage Current ($T_j=150^{\circ}\text{C}$)	$V_{DS}=480V, V_{GS}=0V$	-	-	100	μA
I_{GSS}	Gate-Source Leakage	$V_{GS}=\pm 30V$	-	-	± 100	nA
Q_g	Total Gate Charge ³	$I_D=1.4A$	-	14	20	nC
Q_{gs}	Gate-Source Charge	$V_{DS}=480V$	-	2	-	nC
Q_{gd}	Gate-Drain ("Miller") Charge	$V_{GS}=10V$	-	8.5	-	nC
$t_{d(on)}$	Turn-on Delay Time ³	$V_{DD}=300V$	-	9.5	-	ns
t_r	Rise Time	$I_D=1.4A$	-	12	-	ns
$t_{d(off)}$	Turn-off Delay Time	$R_G=10\Omega, V_{GS}=10V$	-	21	-	ns
t_f	Fall Time	$R_D=214\Omega$	-	9	-	ns
C_{iss}	Input Capacitance	$V_{GS}=0V$	-	155	240	pF
C_{oss}	Output Capacitance	$V_{DS}=25V$	-	27	-	pF
C_{rss}	Reverse Transfer Capacitance	$f=1.0MHz$	-	14	-	pF

Source-Drain Diode

Symbol	Parameter	Test Conditions	Min.	Typ.	Max.	Units
V_{SD}	Forward On Voltage ³	$I_S=1.4A, V_{GS}=0V$	-	-	1.5	V
t_{rr}	Reverse Recovery Time	$I_S=1.4A, V_{GS}=0V,$	-	360	-	ns
Q_{rr}	Reverse Recovery Charge	$dI/dt=100A/\mu s$	-	1970	-	nC

Notes:

1. Pulse width limited by Max. junction temperature.
2. Starting $T_j=25^{\circ}\text{C}$, $V_{DD}=50V$, $L=50mH$, $R_G=25\Omega$, $I_{AS}=1.4A$.
3. Pulse test
4. Surface mounted on 1 in^2 copper pad of FR4 board

THIS PRODUCT IS SENSITIVE TO ELECTROSTATIC DISCHARGE, PLEASE HANDLE WITH CAUTION.

USE OF THIS PRODUCT AS A CRITICAL COMPONENT IN LIFE SUPPORT OR OTHER SIMILAR SYSTEMS IS NOT AUTHORIZED.

APEC DOES NOT ASSUME ANY LIABILITY ARISING OUT OF THE APPLICATION OR USE OF ANY PRODUCT OR CIRCUIT DESCRIBED HEREIN; NEITHER DOES IT CONVEY ANY LICENSE UNDER ITS PATENT RIGHTS, NOR THE RIGHTS OF OTHERS.

APEC RESERVES THE RIGHT TO MAKE CHANGES WITHOUT FURTHER NOTICE TO ANY PRODUCTS HEREIN TO IMPROVE RELIABILITY, FUNCTION OR DESIGN.

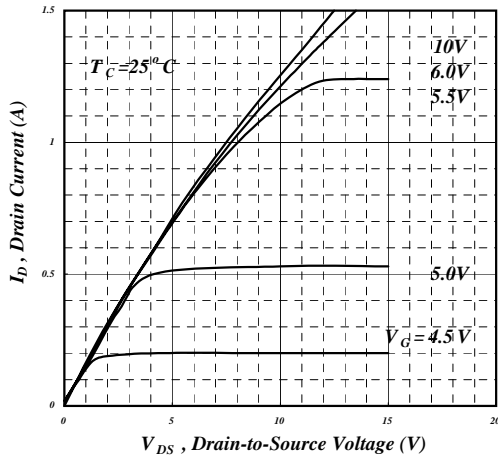

Fig 1. Typical Output Characteristics

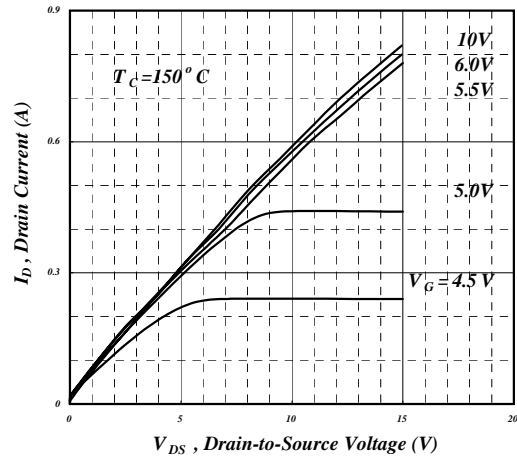

Fig 2. Typical Output Characteristics

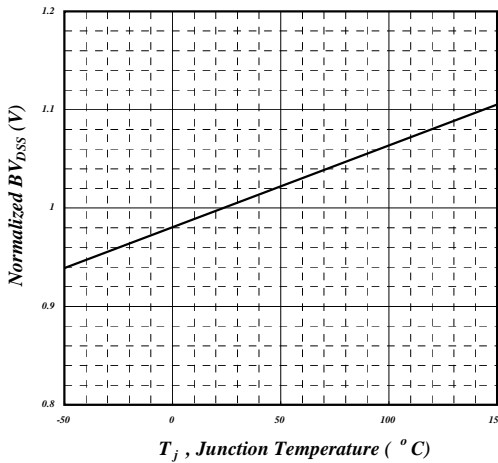

Fig 3. Normalized BV_{DSS} v.s. Junction Temperature

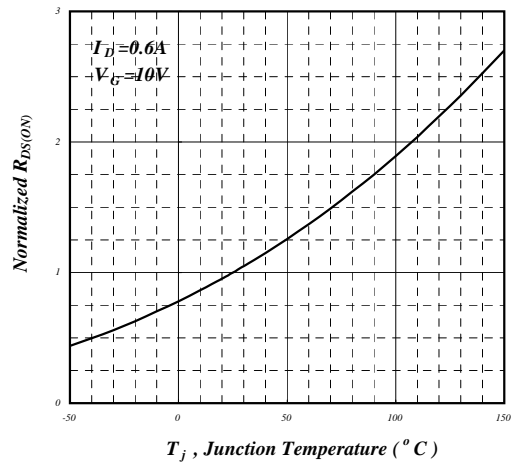

Fig 4. Normalized On-Resistance v.s. Junction Temperature

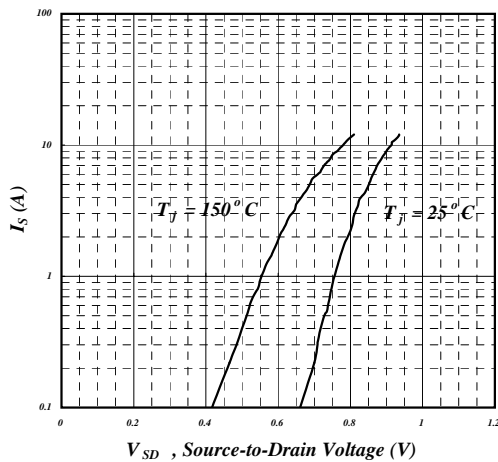

Fig 5. Forward Characteristic of Reverse Diode

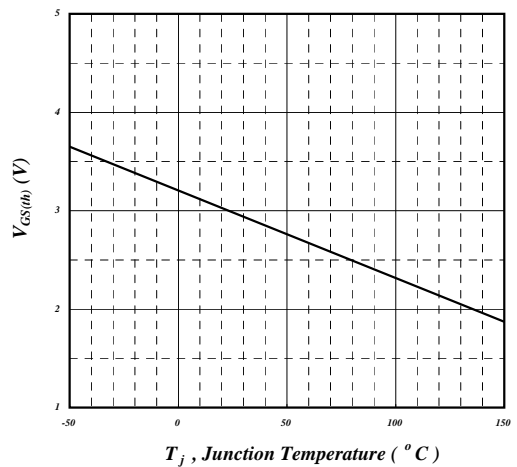

Fig 6. Gate Threshold Voltage v.s. Junction Temperature

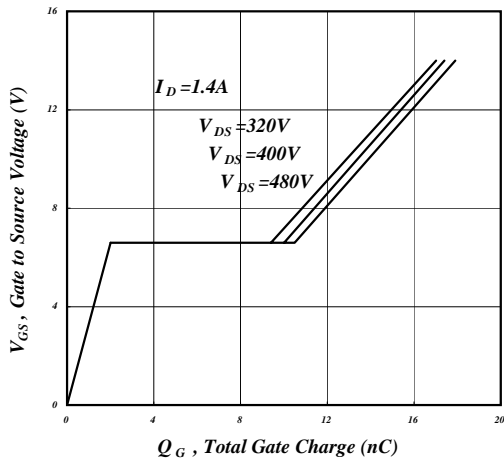

Fig 7. Gate Charge Characteristics

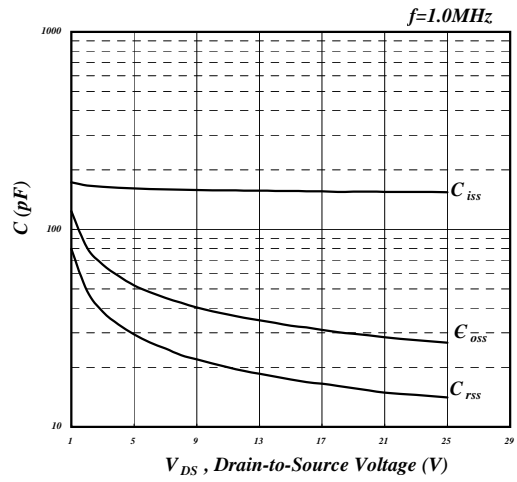

Fig 8. Typical Capacitance Characteristics

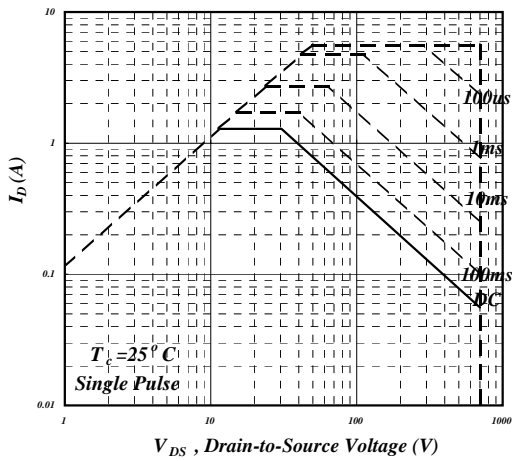

Fig 9. Maximum Safe Operating Area

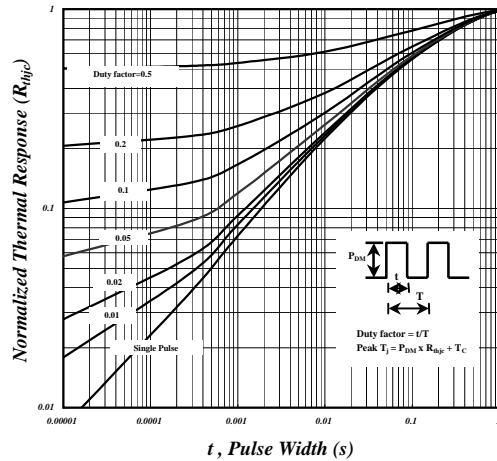

Fig10. Effective Transient Thermal Impedance

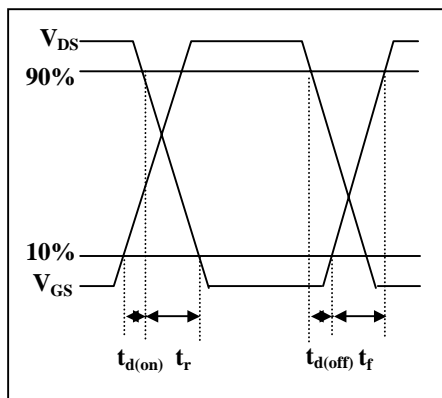

Fig 11. Switching Time Waveform

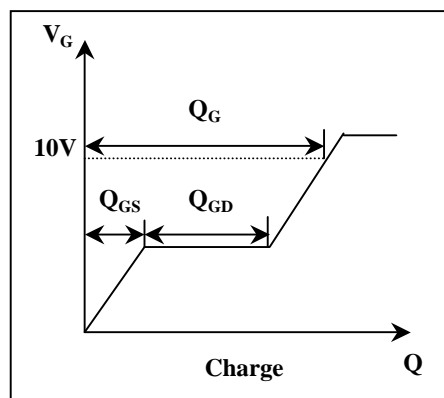
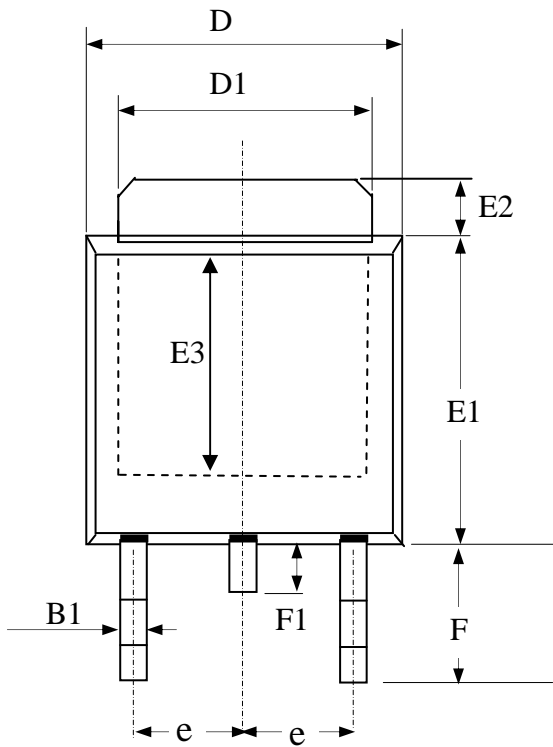

Fig 12. Gate Charge Waveform



Package Outline : TO-252



SYMBOLS	Millimeters		
	MIN	NOM	MAX
A2	1.80	2.30	2.80
A3	0.40	0.50	0.60
B1	0.40	0.70	1.00
D	6.00	6.50	7.00
D1	4.80	5.35	5.90
E3	3.50	4.00	4.50
F	2.20	2.63	3.05
F1	0.5	0.85	1.20
E1	5.10	5.70	6.30
E2	0.50	1.10	1.80
e	--	2.30	--
C	0.35	0.50	0.65

- 1.All Dimensions Are in Millimeters.
- 2.Dimension Does Not Include Mold Protrusions.

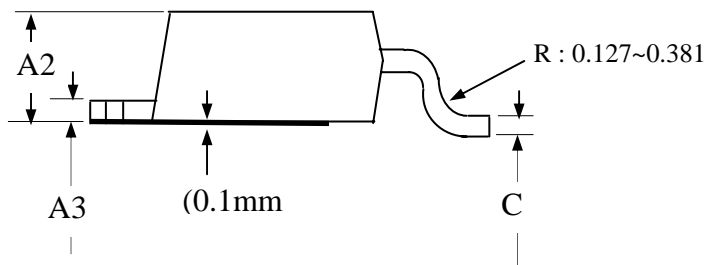

Part Marking Information & Packing : TO-252

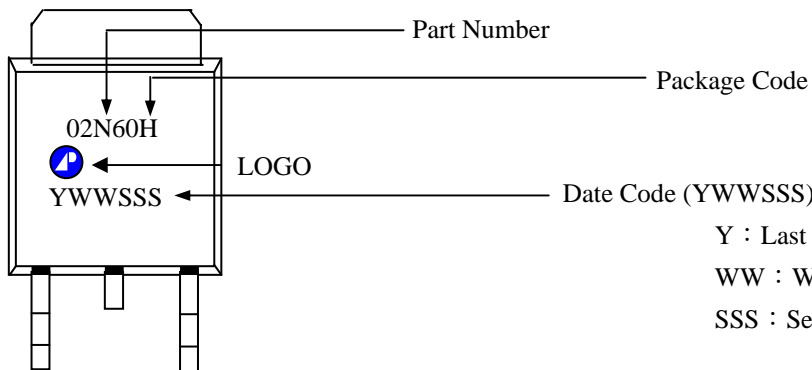

Y : Last Digit Of The Year
 WW : Week
 SSS : Sequence



Package Outline : TO-251

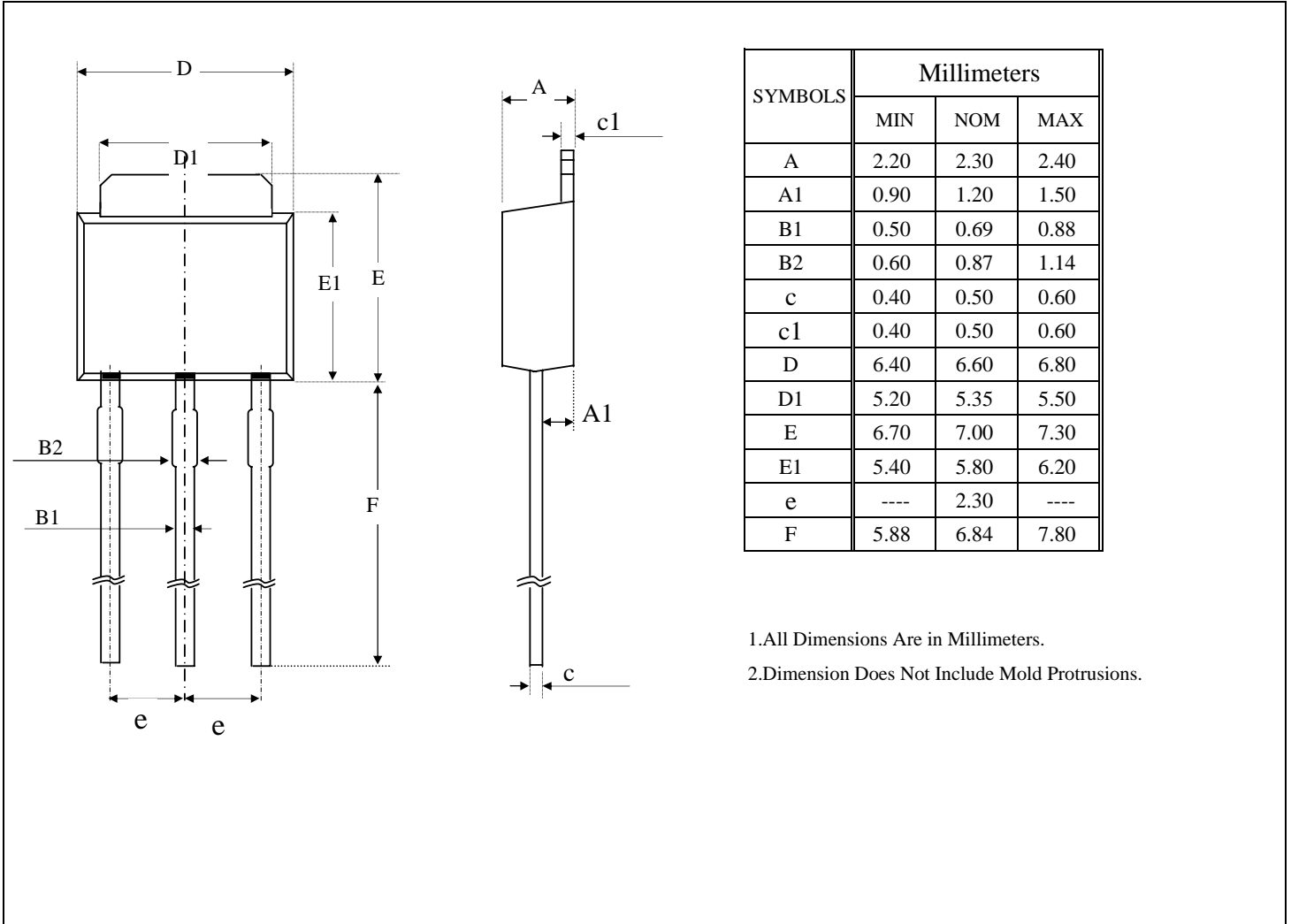

Part Marking Information & Packing : TO-251

